

DIGITAL 20 WORKING 24

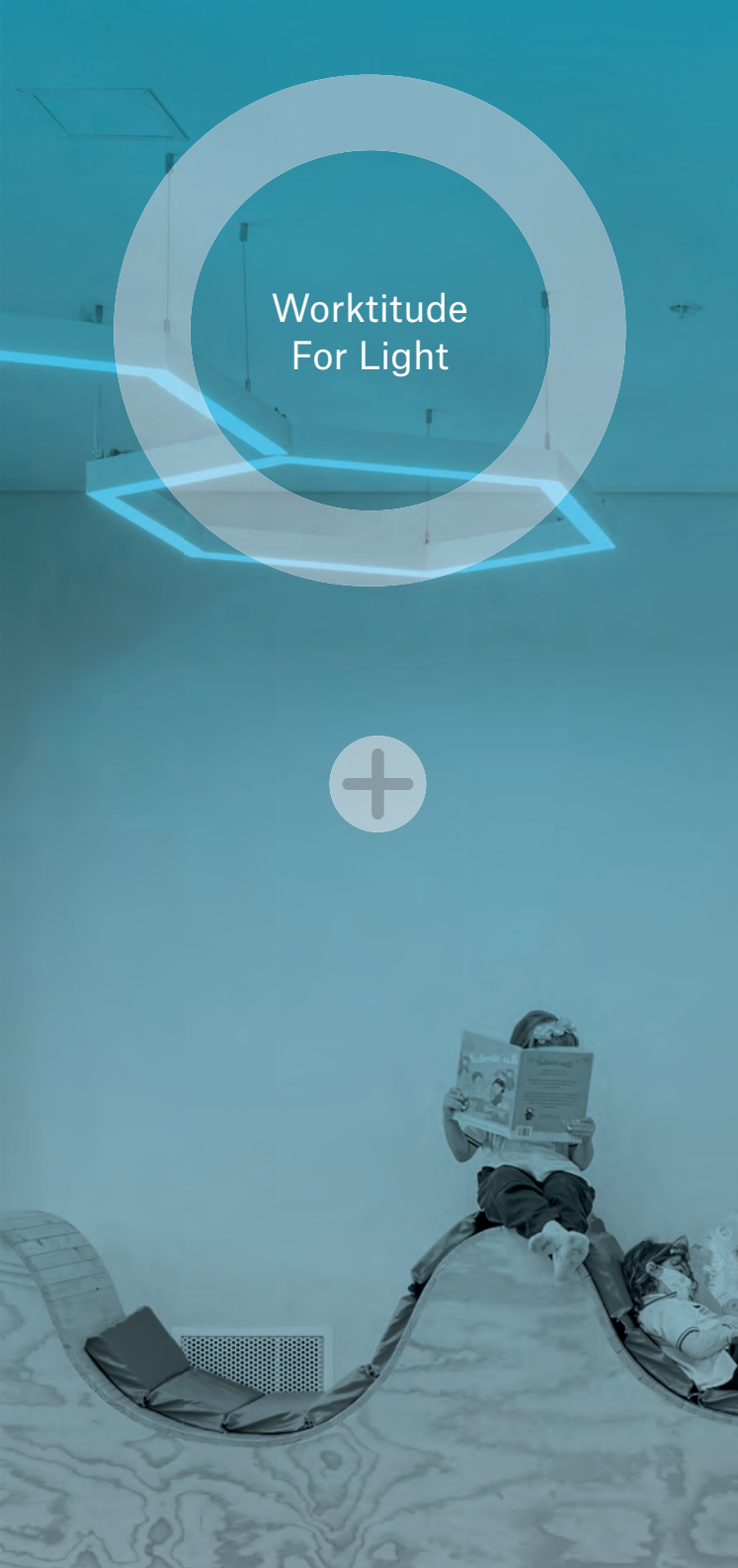

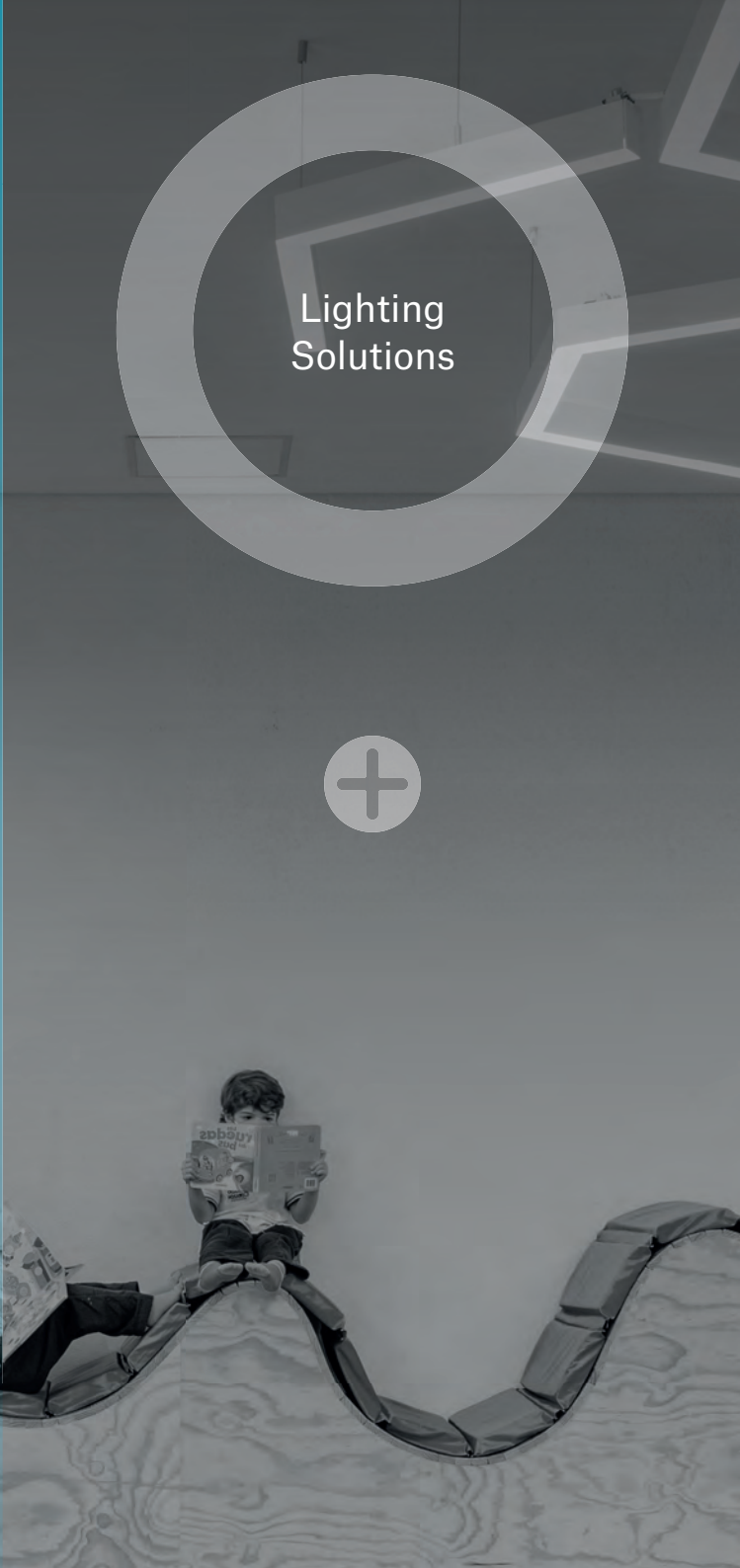

Worktitude
For Light



Lighting
Solutions

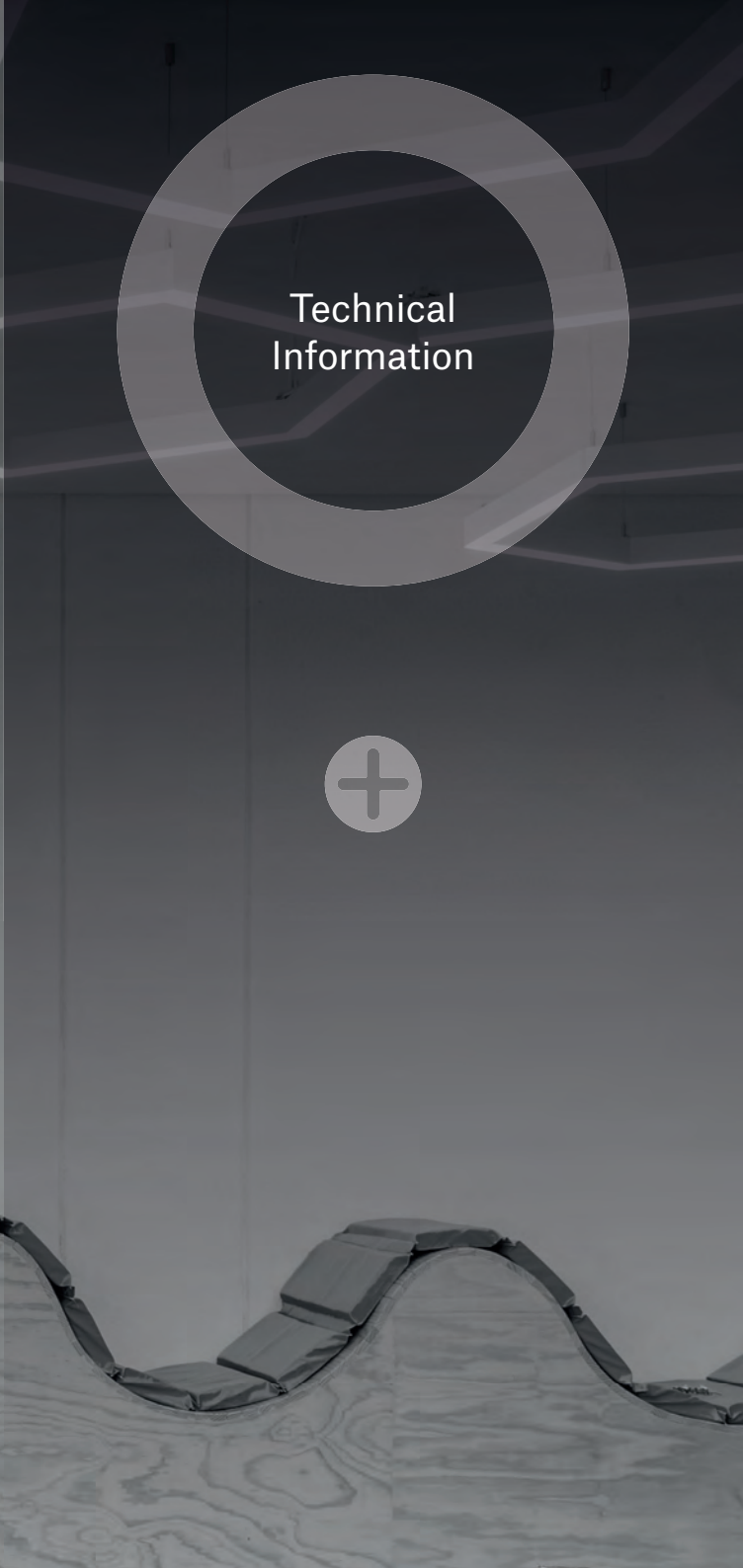

Technical
Information





WORKTITUDE FOR LIGHT

1.

WORKTITUDE FOR LIGHT

- Highlights

WORKING PATHS

- Worktitude for Wellbeing
- Worktitude for Life
- Worktitude for Innovation

2.

SEGMENTS

3.

SERVICES LAMP+

4.

CIRCULIGHT

Worktitude For Light

Lamp is work and attitude,
we are *Worktitude for Light*.



We advise, we design, we produce and make your technical lighting projects possible. For 50 years, Lamp has maintained its essential commitment: to bring to life functional and customized solutions for our customers' lighting challenges, adapted to any architectural project around the world.

Working for light that works

Light is our DNA

We have been turning our **clients' lighting challenges into reality for 50 years.** We combine **experience, know-how and continuous evolution,** from our manufacturing process to our consultancy services.

International vision, local commitment

We are present **in over 70 countries** thanks to **our factory and Terrassa HQ,** as well as our **8 subsidiaries.**

Team

Engineers, designers, technicians and a myriad of **professional profi es work together** on your next project.

Co-Creation

At Lamp we deliver value to your project by **developing tailor-madelighting solutions to suit any application.**

Light is our DNA

We have been **turning our clients' lighting challenges into reality** for 50 years. We combine **experience, know-how and continuous evolution**, from our manufacturing process to our consultancy services.

We have implemented the latest technological advances into our lighting solutions, always focused on the commitment to light quality that each project needs.

We support and defend good lighting. And, as a result, we created the Lamp Awards, to reward creativity, innovation and sustainability of lighting projects.

International vision, local commitment

Our international perspective makes it possible for us to offer lighting solutions that can address projects comprehensively **while maintaining our commitment to the local market** thanks to the presence of our teams in the different subsidiaries and sales offices.

We think globally, solve challenges with local commitment and follow-up.

We are **present in over 70 countries** thanks to our factory and Terrassa HQ, as well as our 8 subsidiaries.



Team

Engineers, designers, technicians and a myriad of professional profiles work together on your next project.

We design and manufacture all our portfolio's products in our HQ in Terrassa, Barcelona (Spain).

Lamp's own designs coexist with creations by prestigious collaborators in our catalogue.

We work in **partnership** with experts in fields such as sustainability, acoustic conditioning,...

Co-creation

At Lamp **we deliver value to your project by developing tailor-made lighting solutions to suit any application.**

Our co-creation service ranges from adapting products currently available in the catalogue to custom made-to-measure solutions on a client-by-client basis.

FORMAL

TECHNOLOGICAL

LIGHT

DOCUMENTATION

NEW DEVELOPMENTS





WORKTITUDE FOR **WELLBEING**

We understand **lighting as a fundamental element for improving people's well-being**, analysing **the visual and non-visual effects of light**.

We believe that light is born in each luminaire, but lives in the space it illuminates and in the person who works or lives there. Whether it is a product, a service or a project, we build on and for the users, taking into account the physical characteristics of the space and the tasks that will be carried out in it.



HEADQUARTERS METGES
SENSE FRONTERES BARCELONA
(ESPAÑA)



Visual comfort

Luminaires with high visual comfort

Specially designed for users to perform concentration and work tasks, with medium-high lighting levels and high comfort requirements, such as offices, classrooms, health and wellness spaces.

Luminaires with a low degree of glare by means of:

- Tech ultracomfort diffuse s (UGR<12) and Opal confort diffuse s (UGR <16)
- Optical options and high degree of shielding (UGR <14)
- Direct-Indirect light distribution



Photobiological risk

For those spaces with high visual comfort requirements due to a more sensitive type of user, such as children or elderly people, as well as spaces where users are exposed to artificial light for long periods, such as kindergartens, educational centres, hospitals, laboratories, offices, senior residences, etc., using luminaires classified as **“Exempt from photobiological risk - Group 0”** according to the **UNE 62471 standard is recommended.**

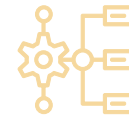

Technological Gradient

Implementing a Technological Gradient according to the needs of the project:



Standard LED Dynamic Lighting

Technology that enables colour temperature variation (2700-6500 K) by selecting the most suitable colour temperature for the lighting level.

Wellbeing Lighting “Reconnecting with nature”

Technology that emulates the natural biorhythms of the human being, maximising circadian activation. Wellness-focused light with high CRI levels (>97), R9 (>50) and high circadian stimulation.

WHAT OFFERS EACH TYPE OF LIGHTING?

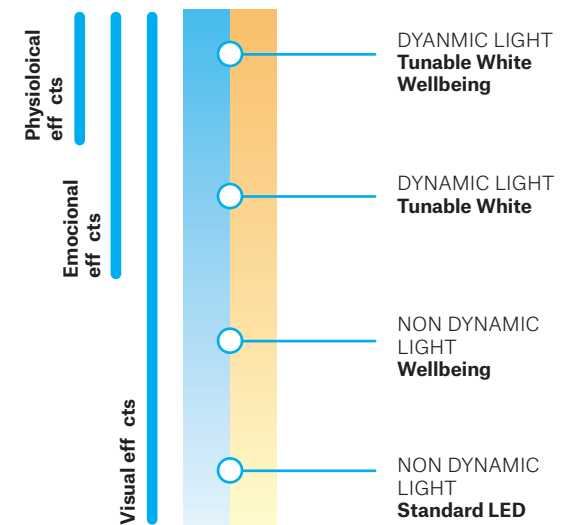

Design of lighting itineraries

Hospitals (Rooms)

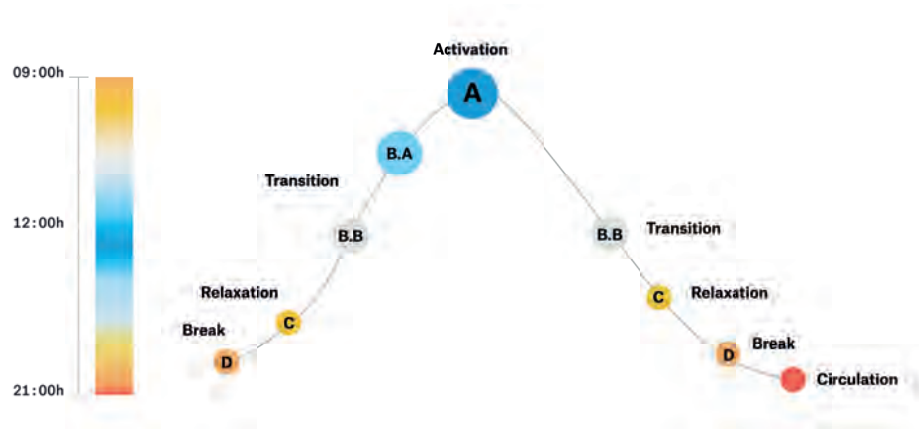

Hospitals (Workers)

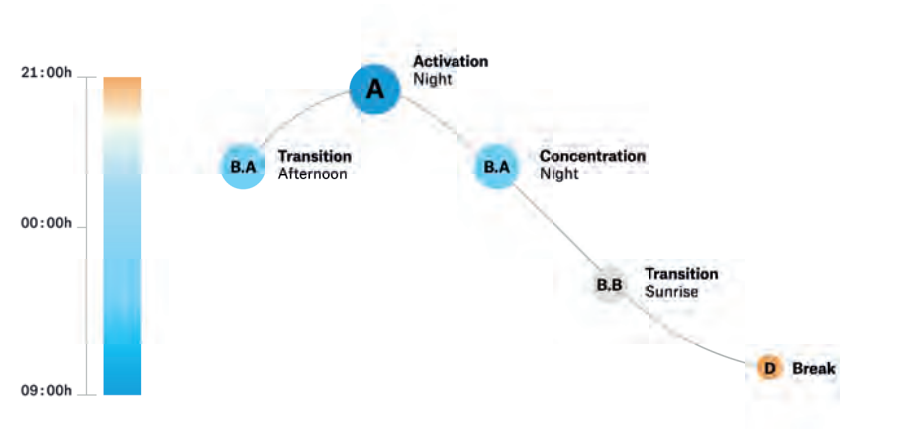

Office

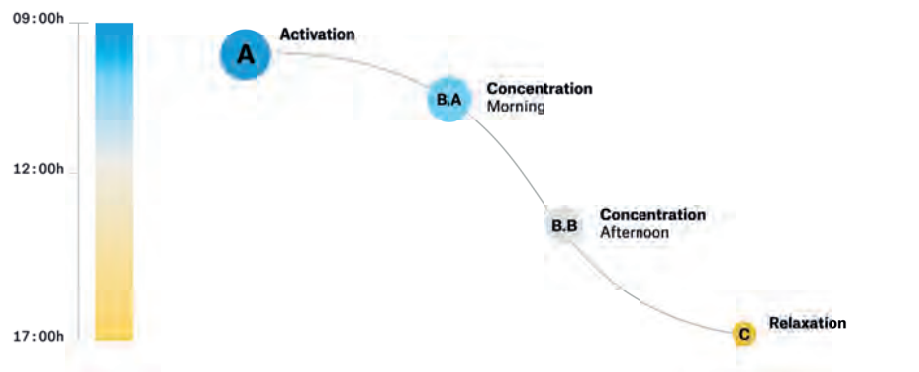

Schools

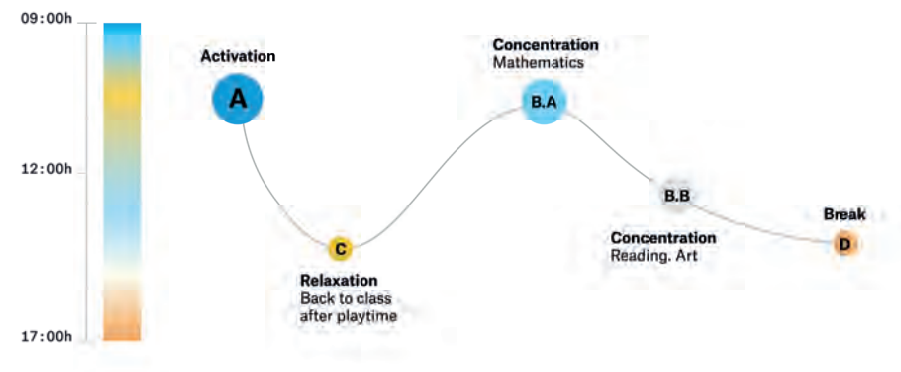



WORKTITUDE FOR **LIFE**

We encourage projects that have a **positive impact on the environment and promote a more sustainable lighting industry.**

We believe that bringing a space to life requires the shared effort of many companies and professionals working responsibly with the **aim of reducing the environmental impact along the entire value chain.** We do our bit by providing realistic, efficient, sustainable solutions that are in line with the current climate reality.





Sustainability committee

Stable committee incorporated into the company's organisation chart, responsible for **managing the sustainability plan, collecting proposals and prioritising actions.**

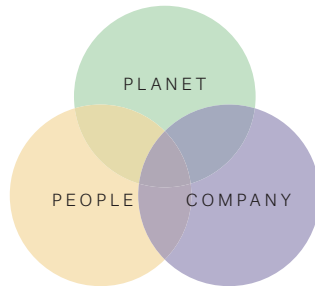

Equality and equity plan

It is part of the **Target Gender Equality 2022-2023** accelerator programme to boost the **contribution to SDG 5 for gender equality.**



Training and environmental awareness plan

Aimed at our teams, as well as external dissemination actions.



Sustainability plan

3-year plan, articulated in three axes:

- **Environmental** (Planet).
- **Social** (People, health and wellbeing).
- **Economic** (Company, profitability and reputation).



Public commitment and transparency

- **Adherence to the UN Global Compact** as a public commitment to align with the **Ten Universally Accepted Principles** in the areas of human rights, labour standards, environment and anti corruption.
- **Support of the UN goals** embodied in the **Sustainable Development Goals (SDGs).**
- Commitment to the preparation and publication of the **Progress Report (2023).**



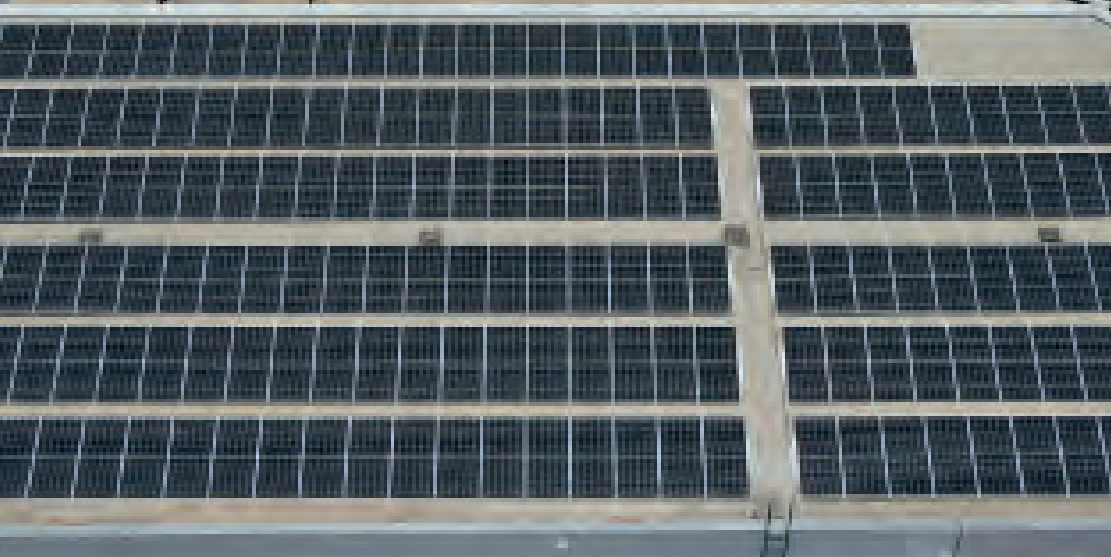

Energy transition

- Use of renewable energies thanks to the **installation of solar panels in HQ, which means 40% self-consumption.**
- Commitment to the progressive electrification of the vehicle fleet.



Relationship with suppliers

- **Prioritisation of local suppliers with sustainability policies and carbon footprint reduction.**
- Optimisation of transport routes.
- Strengthening relationships to improve the social reality of the environment.



Reducing the environmental footprint

Prioritising actions to help us **reduce CO2 and other GHG** (Greenhouse Gas) emissions, both direct and indirect.

- **Lamp's GHG calculation report** contemplating its **Scope 1,2 and 3 emissions in 2022.**

+info



Waste management

Plan for constant improvement in waste management, such as the reduction of plastic packaging, optimisation of packaging by eliminating expanded polystyrene elements,...



Certifications and standards

- ISO 9001 and 14001 certifications.
- GOLD classification by Ecovadis ranking, which **places us in the top 3% of companies with the best performance in terms of social responsibility.**
- Progressive EDP management of our products based on LCA (Life Cycle Assessment).
- Use of recycled aluminium with ASI seal.

+50%



of the references that make up our catalog have **Environmental Product Declarations.**





Measuring impact

- Implementation of software to **manage and report on all sustainability and CSR activity.**
- **Progressive LCA** (Life Cycle Assessment) of our product families.



Life cycle analysis (LCA)

+info

Sample of the **environmental performance of the product expressed in KgCO2** according to LCA phases.



Ecodesign

Implementation of design and conceptualisation strategies to **promote the circularity of our products and reduce their environmental impact.**

Migration to the use of recycled materials such as recycled aluminium, rPET, rCork, and/or biodegradable materials,...



Research and development

R&D projects developed by our own internal teams and external experts to **develop innovation that minimises environmental impact** (new materials, additive manufacturing, packaging optimisation, etc.)



Stormbell 80 R-CORK



MATERIAL	Recycled cork
COMPOSITION	80-90% recycled cork stoppers
KG	0,227
ORIGIN	40 recycled wine stoppers

Stormbell 80 R-PET



MATERIAL	Polyeste Felt
COMPOSITION	20-60% rPET
KG	0,314
ORIGIN	4 recycled water bottles



WORKTITUDE FOR **INNOVATION**

We promote and adopt innovation projects aimed at constant improvement in a transversal way, understanding that **innovation is a systemic and systematic process.**

We anticipate the needs of architects, lighting designers, engineers and interior designers to make their projects a reality and give light to the future, **creating lighting solutions that respond to new ways of living.**

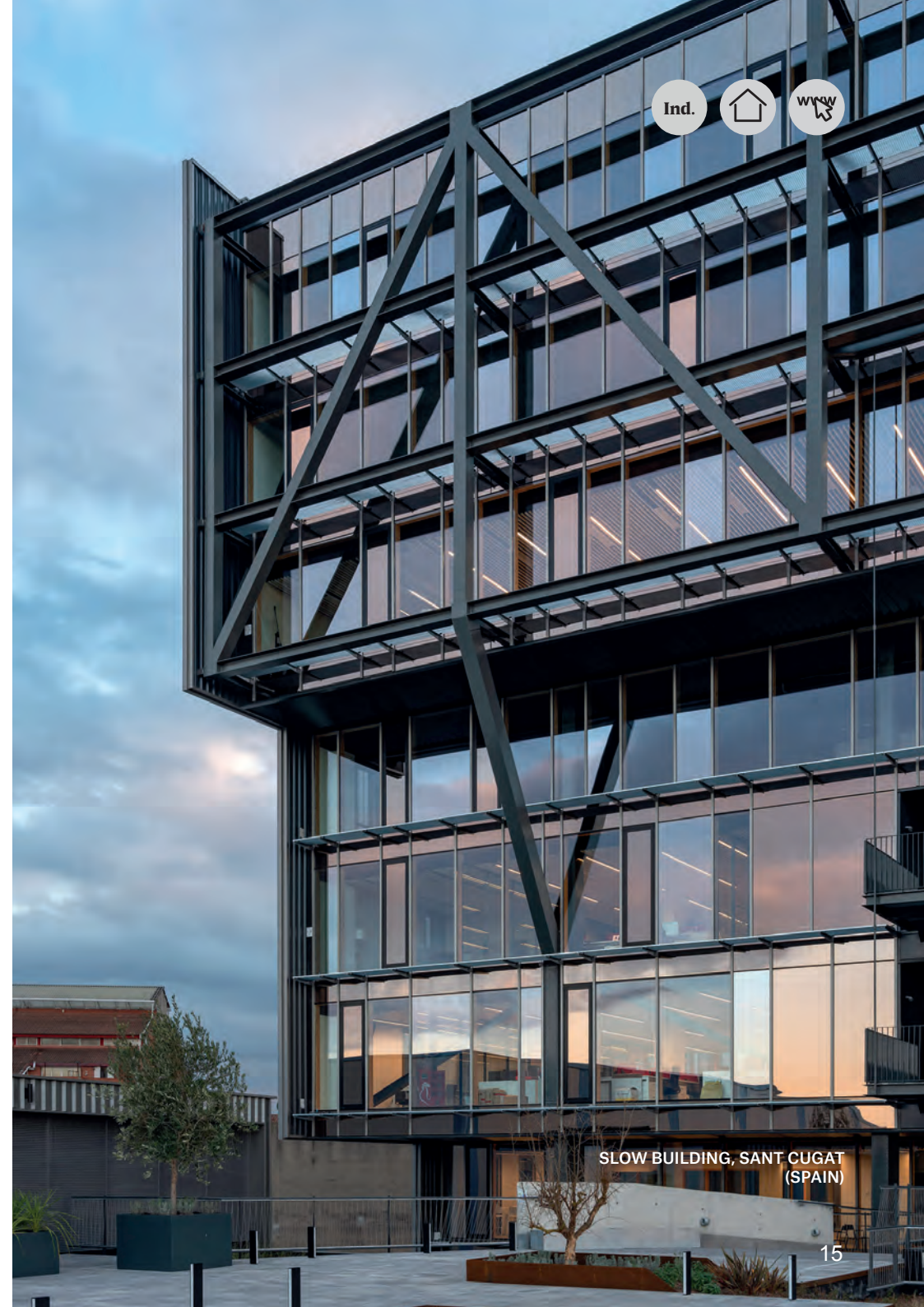

SLOW BUILDING, SANT CUGAT
(SPAIN)



Working groups

We create **interdisciplinary working groups**, using agile and self-managed methodologies:

- **Sustainability Commite**
- **Innovation Commite**



Application segments

Depending on the **different contributions that light brings to the user's experience** in each space, we redefine the specific application segments.



Collaborative ecosystems

We develop internal-external **collaboration ecosystems**:

- **R&D research and new materialities**
- **Partnership with adjacent industries**



Your Light

We created an *On Demand* **digital lighting consultancy service**, integrated with the purchase and acquisition process of luminaires.



The Right Light, Your Light



2018

Brand Identity

Redefining the brand's value proposition and corporate and visual identity.

Open For Innovation

Make Lamp a **user-centric organisation** by generating value propositions around **innovative lighting application**.

Implementation of the **Design Thinking, Co-Creation and Visual Thinking methodology** to understand in depth the social needs and requirements, through the NOMADIC project that collected 11 patterns through more than 40 interviews to 10 different professional profiles in more than 10 cities in 5 different countries, carried out by a transversal innovation acceleration group.

2019

2020

Transformation for Innovation

Internal transformation to prepare the organisation to embrace **new business opportunities in the digital age**.

Transformación for circularity

Research and ideation project to analyse challenges and offer new solutions that add **value from lighting** to this **new circular conception of architecture and building**, thanks to a collaborative ecosystem.

2022



Light that brings your **SPACE** to life

EDUCATION · OFFICE · COMMON SPACES · HEALTHCARE & WELLNESS · HIGH DENSITY TRANSIT · RETAIL · ARCHITECTURAL OUTDOOR

Education Light that takes care and improve the educational experience.



LIBRARY EL MOLÍ, MOLINS DE REI (ESPAÑA)



PREESCOLAR SAGRADO CORAZÓN, ENVIGADO (COLOMBIA)

Office Light that promotes collaboration and creativity, as dynamic as the needs of the users.



Common spaces Light that creates a welcoming environment without forgetting the technical aspects and good lighting control.



Healthcare & Wellness

Light focused on comfort and well-being, that improves the user experience.



High density transit

Efficient and durable light to commit with the highest requirements for both: users and architectural space.



Retail Light for highlighting the essence of your products with the most suitable lighting features.



Architectural Outdoor

Light adapted to the human scale to create places with their own identity.



Services Lamp +

Integrative lighting service focusing on the well-being of the end user. We contribute people's well-being through lighting.

The integrative lighting projects we offer with the Lamp+ service follow the **following phases**:

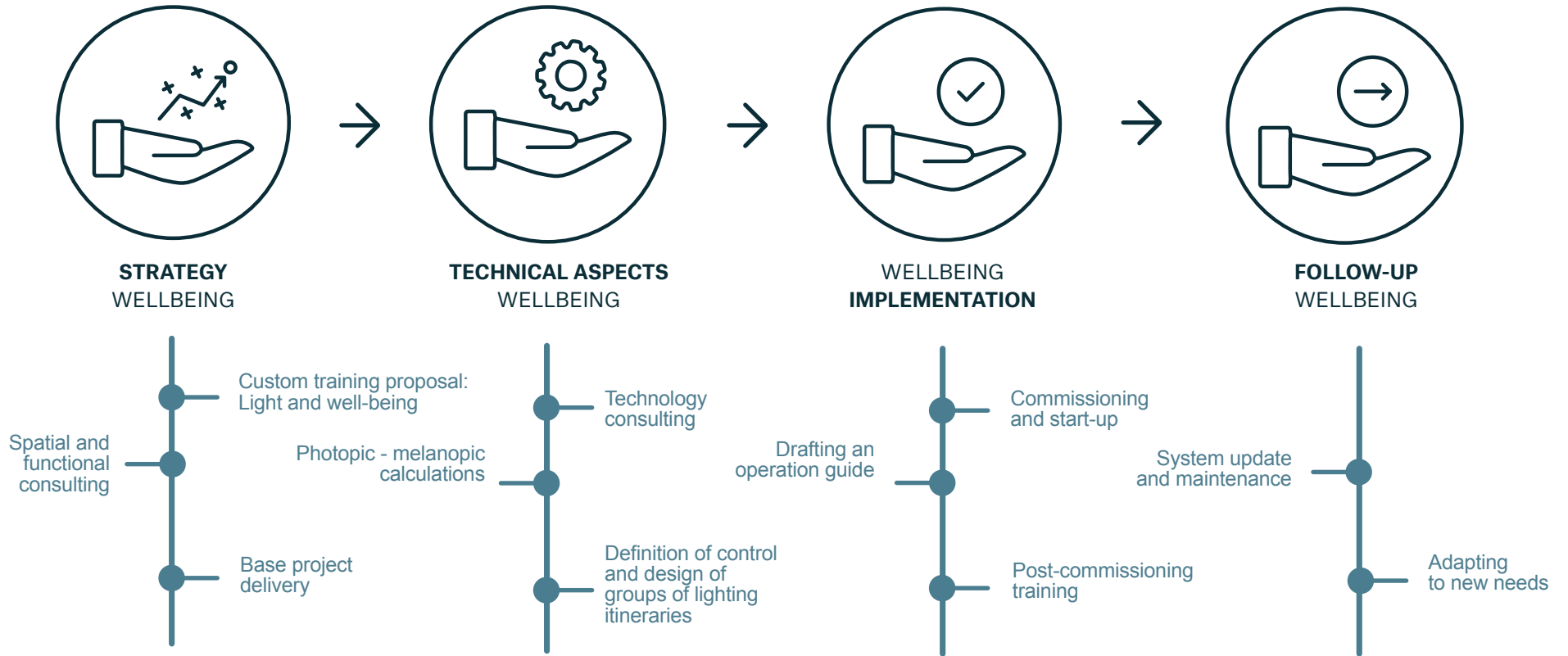

An integrative lighting project is designed according to biological human needs, **integrating the visual and non-visual effects of light**, taking into account not only light's visual impact, but also the emotional and biological effects that light has on people.

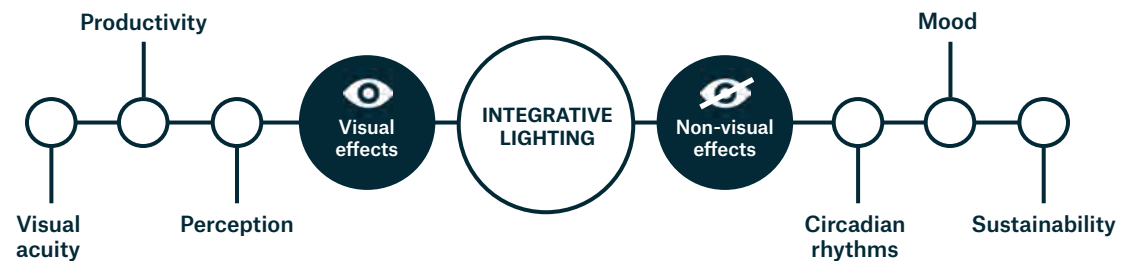

Services



CIRCULIGHT

Upgrade Service

Technological updating service, to promote the renewal and technological updating of installed luminaires. In this way we achieve an increase in the life of the luminaires, by extending their phase of use under the prism of Life Cycle Analysis, providing more resilient lighting solutions.



+ Affordable

Generating between 15-30% **economic savings** compared to the purchase and installation of new luminaires, as well as obtaining an **improvement in energy efficiency** that represents savings of more than 50%.

+ Convenient

Upgrading lighting technology is **faster, less noisy and cleaner** than uninstalling and installing new lighting. **Reducing installation time** by 20-30%. In addition to **improving lighting quality** by incorporating the latest technological advances.

+ Sustainable

Minimises the environmental footprint of the building by **avoiding the generation of waste** in the renovation process and extending the useful life of the luminaires. **Reduces CO2 emissions** both by reducing energy consumption and by reusing and updating the installed product.

EVALUATION, DIAGNOSTIC AND PROPOSAL FOR OPTIMAL SOLUTION

UPGRADE AND MAINTENANCE

INSTALLATION, START-UP AND CERTIFICATION

- 01 Audit and initial analysis of the current state of the installation.
- 02 Feasibility study and environmental impact assessment.
- 03 Recovery of installed luminaires.
- 04 Technical analysis to assess and identify the type of work to be carried out.
- 05 Maintenance and cleaning work.
- 06 Development and manufacture of Plug&Play modules (In-situ/ In-House).
- 07 Digitalisation and integration with control systems.
- 08 Quality tests, electrical and mechanical laboratory testing.
- 09 Extended warranty certification.
- 10 Delivery of material and management of waste generated "in house".
- 11 Turnkey service (installation and commissioning).

Case study

MERCAT DELS ENCANTS, BARCELONA (ESPAÑA)

VIDEO CASE STUDY

The work carried out in the Encants Market, promoted by Mercats de Barcelona, is an example of the transition towards circularity by promoting **the modernisation and creation of resilient infrastructures that extend their life cycle.**

48%
energy
saving

836
upgraded
luminaires

-22
tn de CO₂ eq into
the atmosphere

Better light
quality
provided



INACAP HEADQUARTERS, SANTIAGO DE CHILE (CHILE)

VIDEO CASE STUDY

The headquarters of the INACAP (Professional Training Institute) in Santiago, Chile, have undergone a technological renovation to implement a **more sustainable lighting solution, improving energy efficiency and increasing the service life of the light fittings**, while also improving visual ergonomics.

55%
energy
saving

+20k
upgraded
luminaires

-318
tn de CO₂ eq into
the atmosphere

More
comfortable
lighting



Light for circularity

VALUE CONTRIBUTION

CDW MANAGEMENT PHASE

- Waste recovery (EU Directive 2012/19/EU WEEE).

USE PHASE

- Technological update service.



- Soluciones lumínicas alineadas con estrategias de descarbonización:
Alta eficiencia - uso de materiales reciclados.

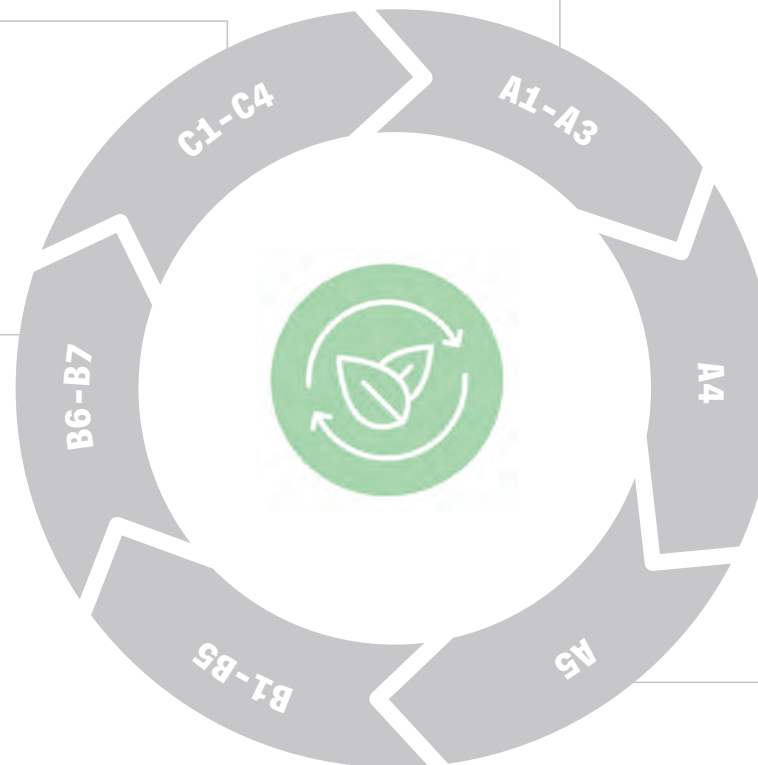

PRODUCTION[~] MANUFACTURING PHASE °A1, A3°

- Reduction of the environmental footprint (embedded + operational emissions).
- Eco-design (3R).
- Waste reduction (use of recycled materials, packaging optimisation).

PLANNING AND DESIGN PHASE

- Environmental footprint information (EDP).
- Digitisation (BIM).
- Modular designs.
- Ease of installation (Plug & Play).
- Customised design (Co-Creation).
- Lighting and technological consultancy.

CONSTRUCTION PHASE

- OŁ·Site Lighting Solutions.
- Customised logistics.



LIGHTING SOLUTIONS

1.

PRODUCT INDEX

2.

LIGHTING FOR LIFE

- LCA: Life Cycle Assessment
- EPD: Environmental Product Information
- Ecodesign and Materiality

3.

LIGHTING FOR WELL-BEING

- Visual comfort
- Photobiological risk

4.

TECHNOLOGY

- Technology
- Technological Gradient
- Wellbeing Technology

5.

NOVELTIES

- Kombic 70 Surface
- Kombic 100 Orientable
- Mun G2
- Hermética G2
- Shot 290 & 380 G3

SOLUTIONS

- Technical Ceiling Lighting Solutions
- Nomadic System
- Tech Ultracomfort: Fil 45
- Tech Ultracomfort: Lamptub 60
- Hance Biophilia

PALETTES



- Wellbeing
- Be Social
- Materiality
- Foundation
- Retropia



INDOOR

HANCE DOWNLIGHT

Downlight













HANCE
Recessed

HANCE
Semi-Recessed

HANCE SPOTLIGHT

Spotlight

HANCE
1000/2000
Surface

HANCE
1000/2000
Semi-Recessed

HANCE
1000/2000
Track



HANCE
3000/4000
Surface

HANCE
3000/4000
Semi-Recessed

HANCE
3000/4000
Track

HANCE 48V

Spotlight







HANCE 48V
500

HANCE 48V
1000/2000

OCULT DOWN.





Downlight

OCULT
Frame / Trimless

OCULT SYSTEM

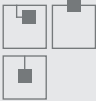
System



OCULT
1000/2000
Surface

OCULT
1000/2000
Semi-Recessed

OCULT
1000/2000
Track

IMAG





Spotlight

IMAG G3
Track

KOMBIC

Downlight

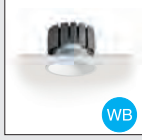
KOMBIC 70
Downlight

KOMBIC 100
Downlight

KOMBIC 150
Downlight

KOMBIC 200
Downlight

Downlight







KOMBIC 70
Surface



KOMBIC 100
Surface

KOMBIC 150
Surface

KOMBIC 200
Surface

DOMO 220

Downlight



DOMO 220



INDOOR

MOODY

Downlight

MOODY
ø 100
Downlight



MOODY
ø 72
Downlight



MOODY
Square
Downlight





MOODY
Asymmetric
Downlight



MOODY
Adjustable
Downlight



Spotlight

MOODY
Pendular

PUZZLE



Downlight

PUZZLE

RING

Downlight

RING
Round



RING
Square



RING
Round

STORMBELL 80

Downlight



STORMBELL 80

STORMBELL

Downlight





STORMBELL



STORMBELL
Deco

QUIET

Downlight





QUIET

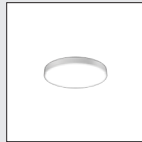

MUN

Downlight / Wall

MUN LIGHT
300





MUN LIGHT
450

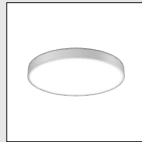

MUN LIGHT
600

Wall

MUN DARK
120



MUN DARK
180



MUN DARK
300

AMBIENT

Wall

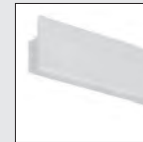
AMBIENT



INDOOR

FIL

General

FIL 35 FIL 45 FIL 45 CURVE FIL SYSTEM FIL 50 FIL 70 FIL 120

LAMPTUB 60

General

LAMPTUB 60

LAMPTUB 80

General

LAMPTUB 80

PLAT

General

PLAT PLAT TECH

MODULAR CUSTOM

General

MODULAR CUSTOM EFFICIENCY MODULAR CUSTOM AIR

HERMETICA

General

HERMETICA

FINE LED STRIP

General

FINE LED STRIP FINE CURVE

GENERAL ACC

General Acc

SUPPORTS SUSPENSIONS

HEALTH SOLUTIONS

Clinic

CLINIC CLINIC Gas

TRANSPORT SOLUTIONS

Metro

STGO TLSE BCN

TRACK

Track

TRACK 48V TRACK 230V



OUTDOOR

SETI

Path





SETI
Soft



SETI
Spot

B-SIDE

Path





B-SIDE



B-SIDE
360

PUCK

Path







PUCK

MUN IP65

Wall







MUN IP65

LUP

Wall





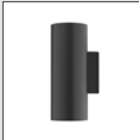

LUP 70
Wall Mounted



LUP 110
Wall Mounted

Downlight





LUP 110
Downlight



LUP 162
Downlight

GAP

**Uplight
Downlight**







GAP

XTREMA

Uplight







XTREMA

TRACE

Wall







TRACE 100
Symmetric



TRACE 200
Aymmetric



TRACE 200
Aymmetric



TRACE 200
Symmetric

URBAN 100

Wall





URBAN 100

DUIT

Wall









DUIT



OUTDOOR

BAZZ

General





BAZZ
Aymmetric
Frame

BAZZ
Opal
Frame

BAZZ
Symmetric
Frame

BAZZ
Wall Washer
Frame

General

BAZZ AIR
Aymmetric
Air



BAZZ AIR
Opal
Air

BAZZ AIR
Symmetric
Air

BAZZ AIR
Wall Washer
Air

BAULINE

General







BAULINE

BAULINE
Air

FLUT

Floodlights

FLUT 180

FLUT 280

SHOT

Spotlight







SHOT 80

SHOT 120

SHOT 180

SHOT 290

SHOT 380

NIU

Urban



NIU

OWL

Urban



OWL

GENERAL ACC.

Supports



VIAL SYSTEMS



Life Cycle Assessment (LCA)

The life cycle analysis allows us to analyse and evaluate **the environmental performance of our products "from cradle to grave"**, quantifying the environmental impacts in each of the stages according to the **UNE-EN 15804:2012+A2:2** standard.

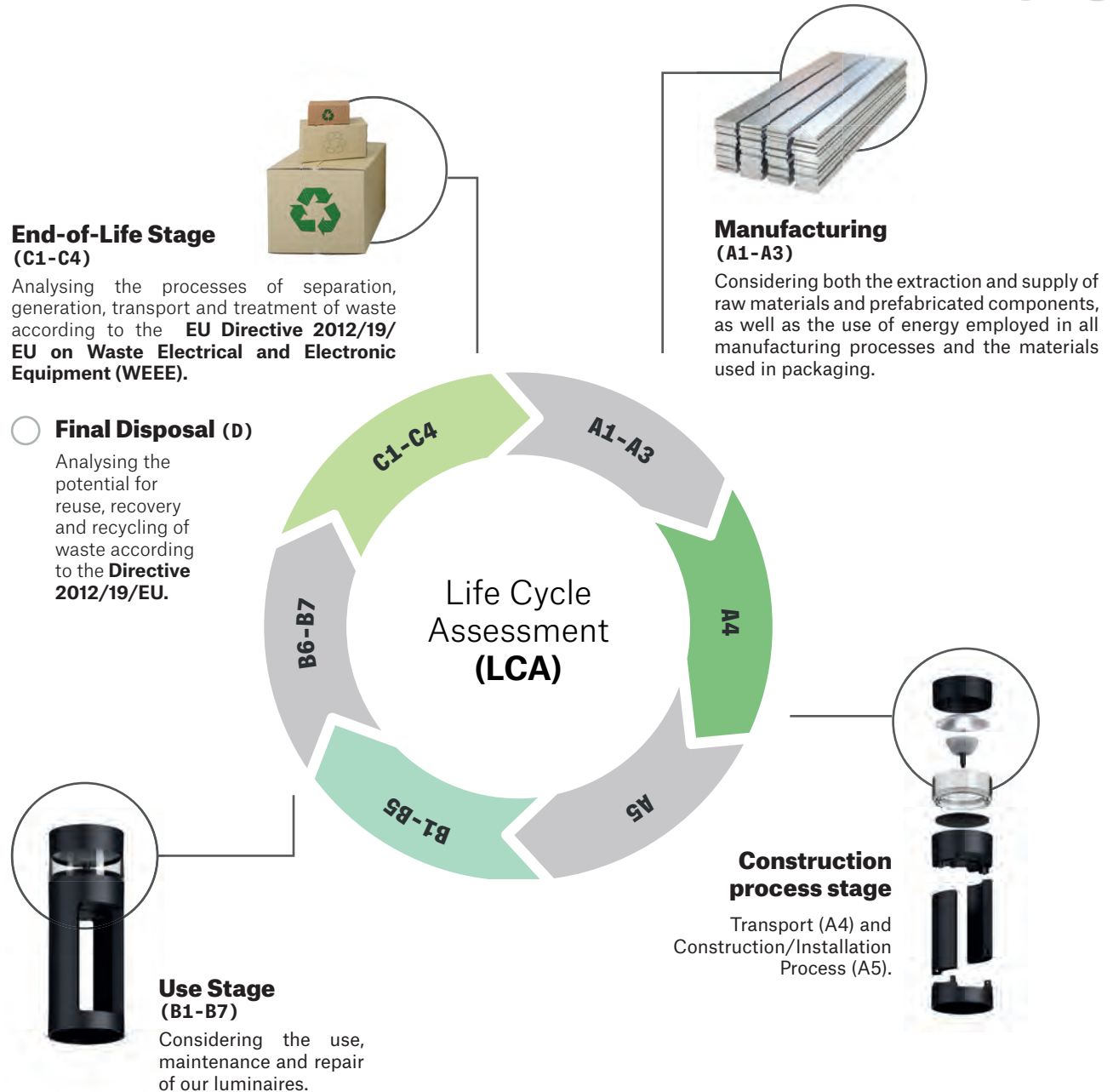



The environmental impacts analysed are among others: **global warming** (GWP), **ozone layer depletion** (ODP), **acidification** (AP) or **resource depletion** (APD).



El ACV de nuestros productos es un proceso imprescindible que nos permite continuar tomando medidas que minimicen el impacto ambiental de nuestras luminarias, y poder ofrecer mejores soluciones lumínicas para cada proyecto.



Environmental Product Information (EPD)

We currently have **Environmental Product Declarations** for more than **50%** of the references that make up our catalogue.



(Environmental Product Declaration)
ISO 14025 & EN 15804

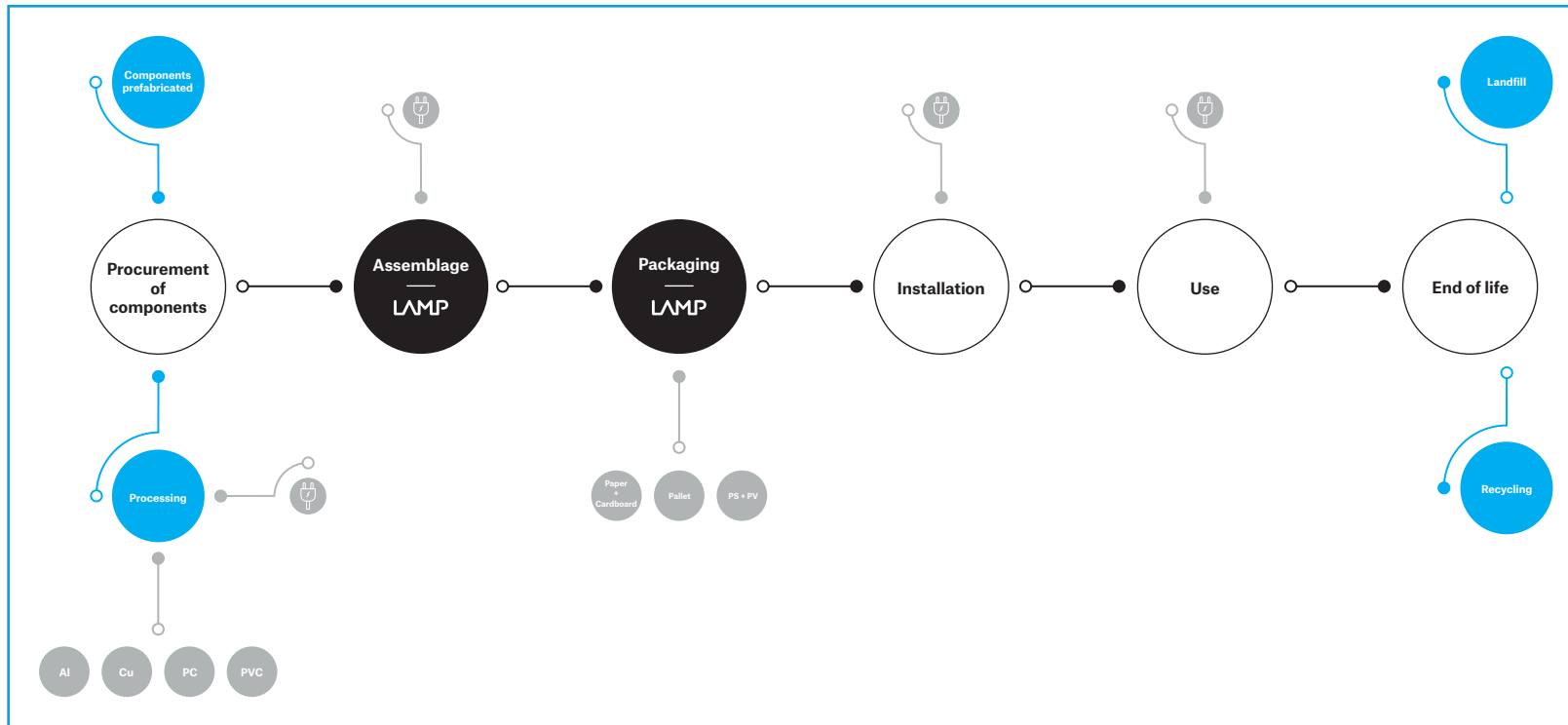



Lighting for Life

Ind.



We contribute with **the necessary actions and information to favour the transition towards a circular economy**, and to achieve the objectives established to curb the climate crisis, showing our impact, both in absolute data (Kg CO2 eq), and the percentage ratio of the impact in each phase.

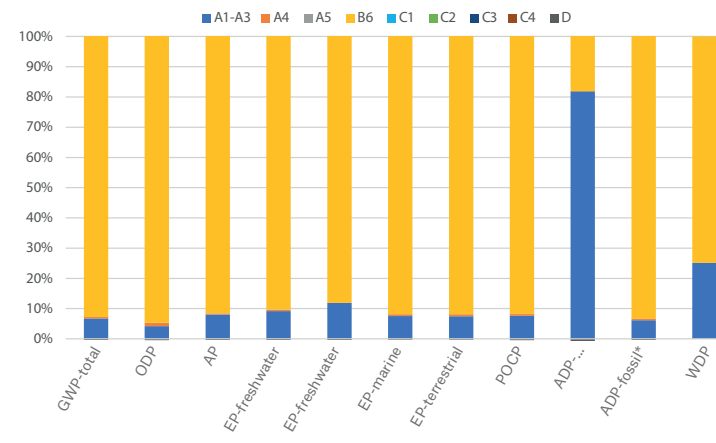
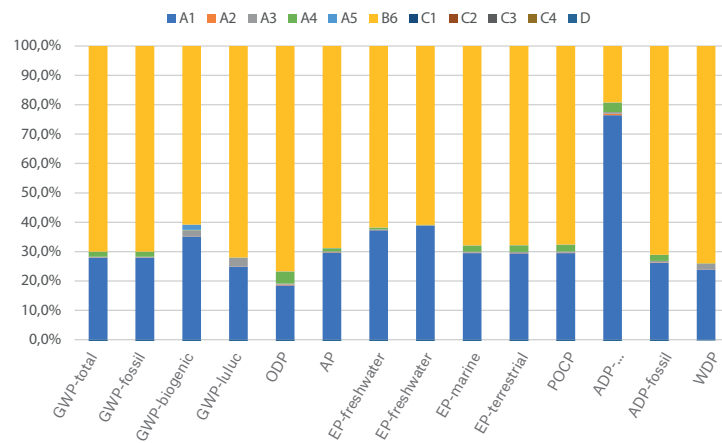

Find this information in:





Ecodesign and materiality

Aluminium R Profile



- Recycled aluminium
70% reduction in direct carbon emissions during manufacture.
- 5% energy use compared to the original process.
- Savings 270 Tn CO² Eq / year
- 42 % reduction of CO² footprint

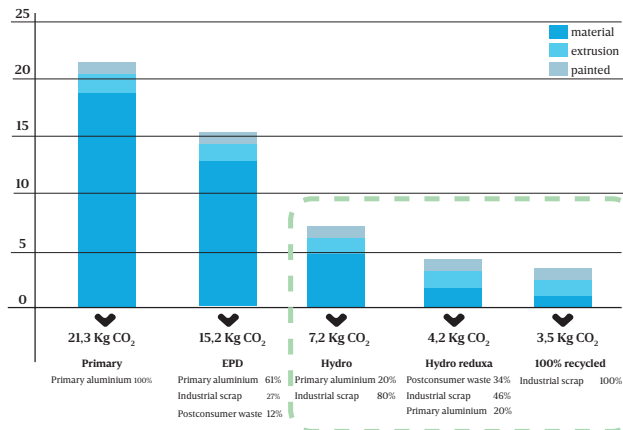

Polycarbonate : R-PC FR white™



"Reflector made of recycled polycarbonate R-PC FR WHITE™ with bromine-free flame retardant. Flammability grade V0 according to UL94. "



- Savings 70 Tn CO² Eq /year
- 96 % reduction of CO² footprint (per part)



Material	Recycled Cork
Composition	80-90% recycled cork stoppers
Kg	0,227
Origin	40 recycled wine stoppers



Material	Polyester Felt
Composition	20-60% rPET (recycled bottles and other containers)
Kg	0,134
Origin	4 recycled water bottles



Visual comfort

Luminaires with high visual comfort

Specially designed for users to perform concentration and work tasks, with medium-high lighting levels and high comfort requirements, such as offices, classrooms, health and wellness spaces.

Luminaires with a low degree of glare by means of:

Tech (UGR <12) and Opal confort diffusers (UGR <16)

Optical options and high degree of shielding (UGR <17)

Direct and Indirect Emission

FIL 35 TECH



LAMPTUB 60 TECH



KOMBIC 70 OPTIC

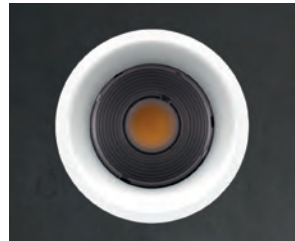

KOMBIC 100 OPTIC



FIL 35/ 45 / FIL 70



DIR/IND

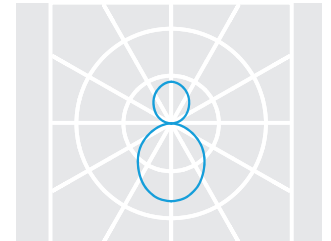

FIL 45



FIL 45 TECH



OCULT

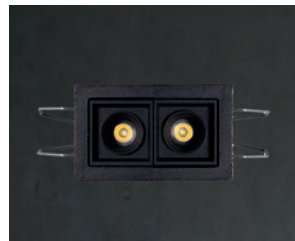

MOODY



LAMPTUB 60



AMBIENT





Photobiological risk

Luminaires exempt from photobiological risk

For those spaces with high visual comfort requirements due to a more sensitive type of user, such as children or elderly people, as well as spaces where users are exposed to artificial light for long periods, such as kindergartens, educational centres, hospitals, laboratories, offices, senior residences, etc., using luminaires classified as **“Exempt from photobiological risk - Group 0” according to the UNE 62471 standard is recommended.**

KOMBIC DOWNLIGHT



KOMBIC SURFACE



FIL



PLAT





Technology

Dynamic Lighting

technology that enables colour temperature variation (2700-6500 K) by selecting the most suitable colour temperature for the lighting level.

FIL 45



PLAT



KOMBIC



KOMBIC SURFACE



Wellbeing Lighting

technology that emulates the natural biorhythms of the human being, maximising circadian activation. Wellness-focused light with high CRI levels (>97), R9 (<50) and high circadian stimulation.

FIL 45



KOMBIC 100



KOMBIC 150



STORMBELL 80





Technological Gradient

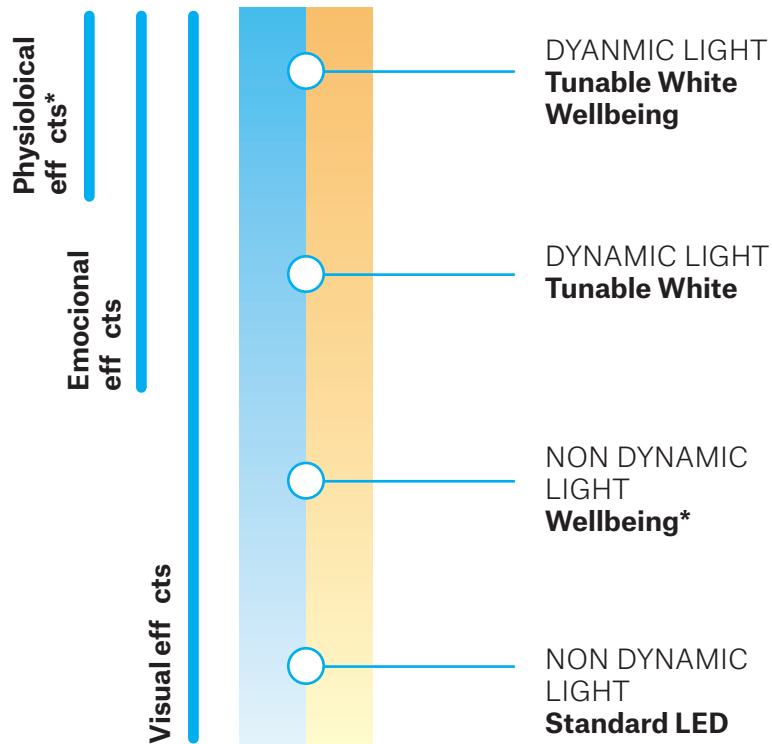

	MONOCHROME	WELLBEING MONOCHROME	TUNABLE WHITE	WELLBEING TUNABLE WHITE
ILLUMINANCES SUITABLE FOR TASKS THAT REQUIRE CONCENTRATION				
LUMINANCE CONTRASTS	●	●	●	●
LIGHTING LEVEL REGULATION	●	●	●	●
CRI>80	●	●	●	●
R9>50	●	●	●	●
SYNCHRONISATION WITH NATURAL LIGHTING (VARIABLE CCT)	—	●	—	●
LIGHT JOURNEYS	—	—	●	●
SPECTRAL SIMULATION OF NATURAL LIGHT	—	—	—	●
CIRCADIAN STIMULATION (VARIABLE CCT)	—	●	—	●
INTEGRATED COLORIMETER	—	—	—	●
SPECTRAL DESIGN				
DIGITALISATION AND REPRODUCTION OF SPECTRA				



Wellbeing Technology

Reconnection with nature

Wellbeing technology focuses on the **well-being of people**, since it allows **respecting the natural biorhythms of the human being**, reducing the most aggressive emissions for vision and maximizing the most effective ones for circadian activation.

Reproduces all visible wavelengths of light accurately imitating **natural sunlight**.

At Lamp we are constantly updating to expand the use of this technology in our products to provide optimal **circadian stimulation**, especially needed during the early hours of the day and regularly considering check color quality metrics, such as CRI and TM- 30, as well as the spectral power distributions (SPDs).

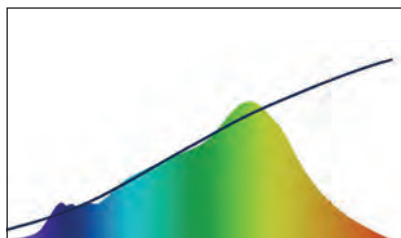

Light Spectrum
LED Wellbeing

LED Wellbeing technology adapts its spectral distribution to provide a continuous curve more similar to daylight.





Wellbeing Technology

What benefits does Wellbeing technology provide?

- **Positive impact on human wellbeing**
Thanks to its spectral distribution, and its optimization of emissions corresponding to 480 nm, it offers high circadian activation, helping to regulate sleep cycles and wakefulness, improves energy levels and promote a general feeling of well-being.
- **Improves visual perception**
Provides better quality and visual definition, reducing eye fatigue and improving visual comfort.
- **Excellent chromatics reproduction**
CRI95 in downlights / CRI98 in linear systems.
- **Accessibility and applicability**
We apply technology in a wide range of products for different environments and spaces, improving the quality of light and user experience.

FIL 45



STORMBELL 80



KOMBIC 100



KOMBIC 150





Palettes

Wellbeing

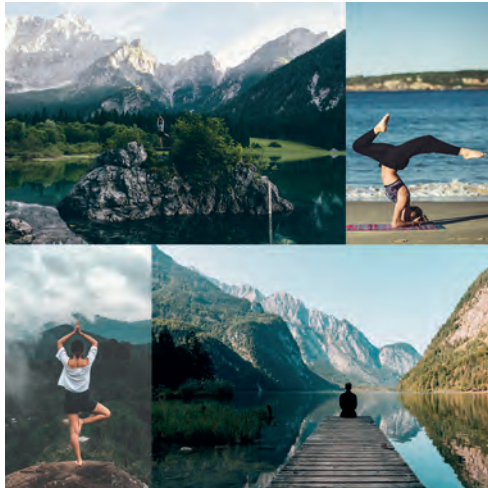

Be Social



Materiality



Foundation



Retropia





Wellbeing

Physical and emotional wellbeing



4050-R90B



1505-Y10R



7024



4030







7001



Be Social

Interrelations

-  4050-R90B
-  1050-B10G
-  7502-R
-  2070-Y80R
-  2011



Materiality

Recovery of materiality, real experiences



1505-Y10R



7024



3010-G



2010-Y20R



3013



Foundation

Facing the complex.



5003



1505-Y10R



7036



7043



9002



Retropia

Dreaming of past places,
imagining a near future.



5009



1016



4010

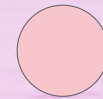

3015



6027



TECHNICAL CEILING LIGHTING SOLUTIONS

Design by Lamp



PLAT OPAL

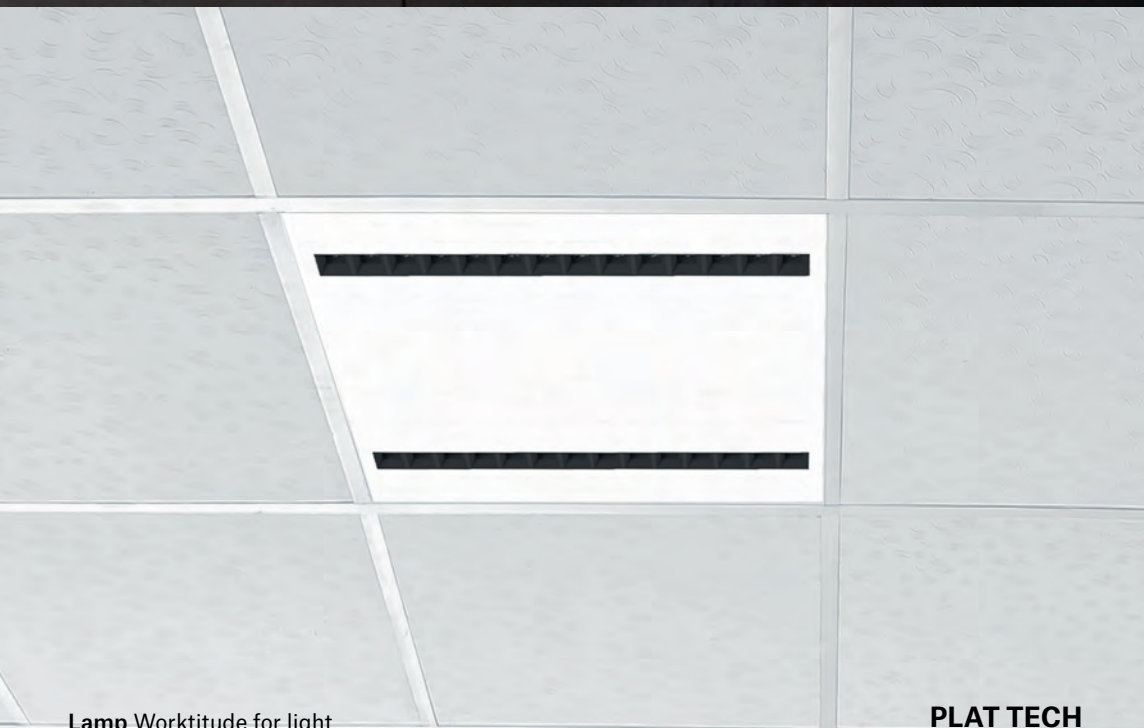

PLAT TECH

+ TECHNICAL INFORMATION

Ind.



Plat

OFFICE/
EDUCATION

The solution for technical ceilings with glare control and high efficiency.



Comfort and wellbeing

PRISMATIC TECH UGR <19.
UGR <12.

Photobiological risk R0.

Flicker free.



Energy efficiency

Efficacy up to **123lm/W**.



Optical quality

Uniform luminance in minimum thickness.



Plat Tech

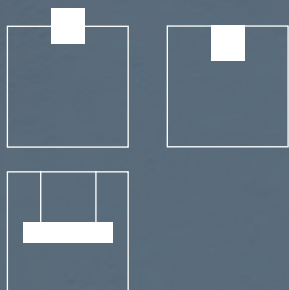

FACILITY

Plat Tech is perfect for **interior lighting**, easily installed **in ceilings with visible and hidden profiles**, as well as **in plaster ceilings**.



DARK LIGHT: DISCREET LIGHTING

Plat Tech satisfies the limit of darkness requirements that classify it as Dark Light: it is **less than 200cd/Im²** above a **viewing angle of 60°**. Thus, **it creates discreet lighting that respects the user's comfort and does not cause glare**.



EFICCIENCY

Designed with a combination of glare-eliminating reflector and high-efficiency optics, guaranteeing glare-free illumination and **optimized energy consumption**.

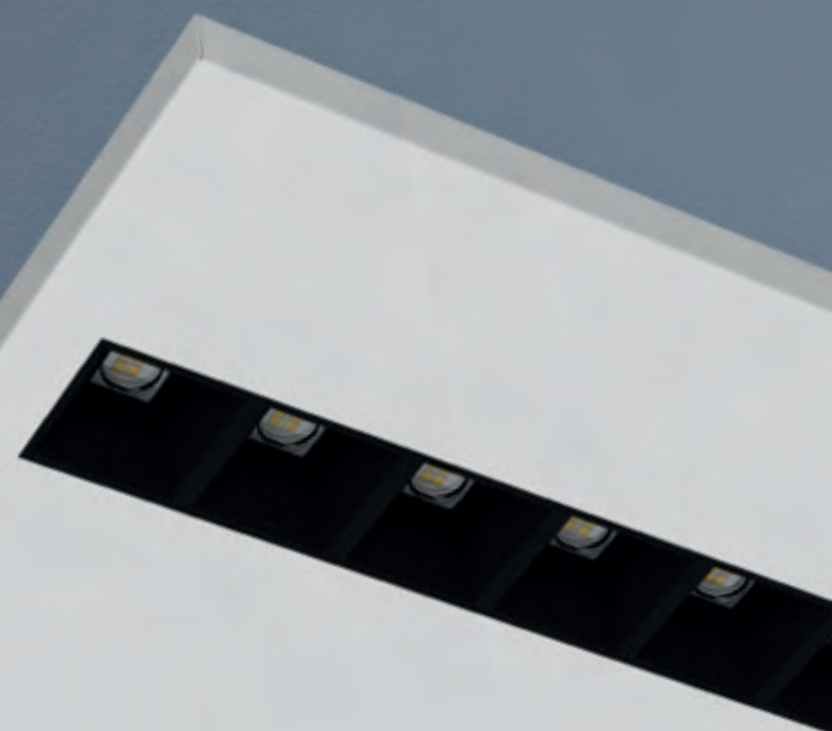



Plat

MODELS

Opal

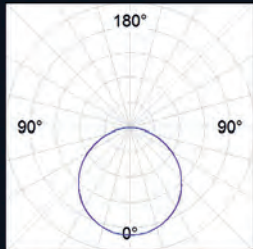

Prismatic

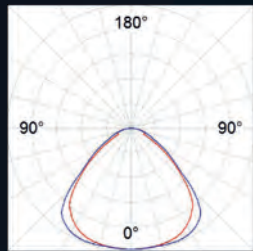

Tech

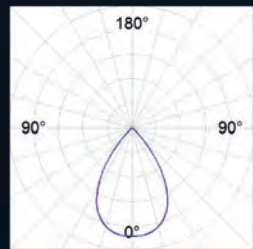

SIZE

600x600 mm
1200x300 mm

LIGHT SOURCE

CRI 80/90
3000 / 3500 / 4000 K
Tunable White (TW)

IP

40/54
65

CONTROL

ON/OFF
DALI
1-10V
CASAMBI

ADDITIONAL ACCESSORIES

Light sensor
Presence sensor
3/5h emergency battery
Quick connector

INSTALLATION



Exposed "T" Lay-in



Exposed "T" Lay-in with recessed tile

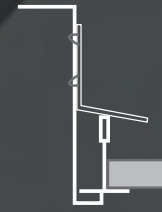

Exposed "T" with adjustable side supports

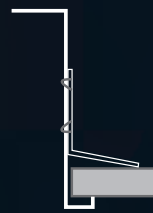

Plaster ceiling with adjustable side supports





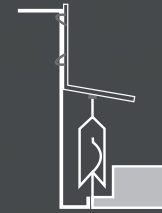



Concealed "T" with adjustable side supports



Snap "T" with adjustable side supports

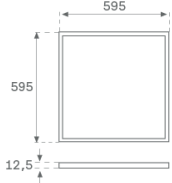
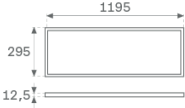
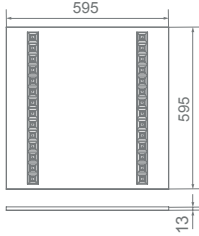

Plat

Models	OPAL	PRISMATIC	TECH
			
Dimensions			
	600x600mm	1200x300mm	600x600mm
Lm LED	4100lm	3500lm	4100lm
CRI	80/90	80/90	90
Beam angle	 Opal 114°	 Prismatic 95°	 Tech 70°
Color temp.	3000 / 4000 / TW	3000 /3500 (Active Warm) / 4000 K	3000 / 4000 K
Gear	ON/OFF - DALI 1-10 V CASAMBI		
IP	40 / 54 / 65 (front) / 67		
Acc. Finishes	White		



MODULAR CUSTOM EFFICIENCY



Lamp Worktitude for light

MODULAR CUSTOM AIR

+ TECHNICAL INFORMATION

Ind.



Modular Custom

OFFICE



Comfort and wellbeing

PRISMATIC with optical foil
UGR <19.

Photobiological risk R0.

Flicker free driver.



Energy efficiency

Efficacy up to **125lm/W**.



Modular design:

Solution adaptable to:

- Different modulations.
- Ceiling formats
- Lighting requirements
- Air return to plenum



Modular Custom

PERSONALIZATION

Highly customizable and adaptable to any type of ceiling: modular, continuous or accessible. This allows us to meet the specific needs of each project, **offering customized solutions.**



MODULAR CUSTOM EFFICIENCY ENERGY EFFICIENCY

The Efficiency model stands out for its efficiency of more than 120lm/W, offering optimal and quality lighting, while consuming less energy, which translates into maintenance savings and a **smaller environmental footprint.**



MODULAR CUSTOM AIR AIR QUALITY

The Air model incorporates air extraction slots with a return to the plenum box.

This system is more efficient and maintains the air quality in the space, ensuring proper ventilation. Return air allows used air to be drawn from the indoor space and redirected to a designated area, where it can be filtered, treated and reconditioned before being re-supplied.

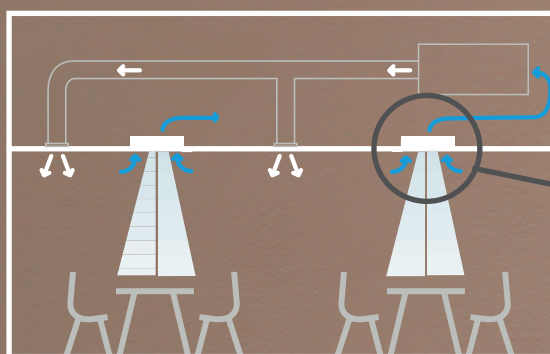

— White line: air expulsion

— Blue line: air return

**Extraction capacity of 40l/sg-144m3/h
for 900x300 mm format**

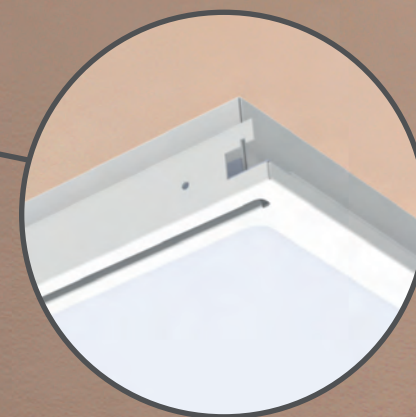



Modular Custom

MODELS

Efficiency

600x600 mm
1200x120 mm

Air

Model with
openings of air
return to plenum

900x300 mm
1200x300 mm
1200x600 mm

LIGHT SOURCE

CRI 80/90
3000 / 3500 / 4000 K
Tunable White (TW)

IP

40/54

CONTROL

ON/OFF
DALI
1-10V
CASAMBI

ACCESSORIES

Light sensor
Presence sensor
Emergency battery 3/5h
Quick connector

INSTALACIÓN We adapt to different types of technical ceilings

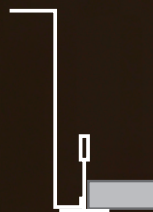

Exposed "T" Lay-in

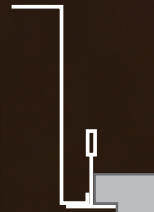

Exposed "T" Lay-in
with
recessed tile

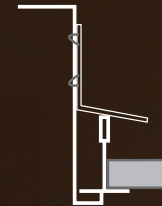

Exposed "T" with
adjustable side
supports



Open cell or
special ceilings
with suspension
assemblies

*Air

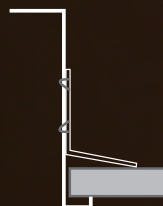

Plaster ceiling with
adjustable side
supports

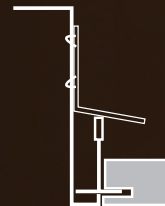

Concealed "T" with
adjustable side
supports



Snap "T" with
adjustable side
supports

Modular

+ TECHNICAL INFORMATION

Ind.



Models

EFFICIENCY



AIR



Dimensions

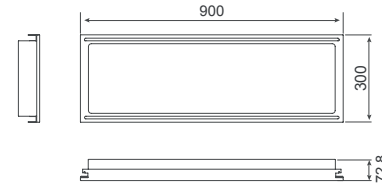
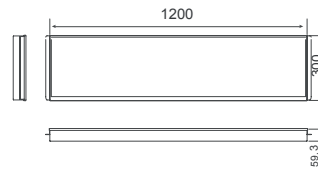
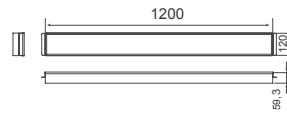
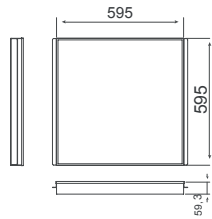

600x600mm 1200x120mm 900x300mm 1200x300mm 1200x600mm

4200lm

3400lm

CRI

80

90

Beam angle



Color temp.

3000 / 4000 K / TW

3000 / 4000 K

Gear

ON/OFF - DALI 1-10 V CASAMBI

40

Acc. Finishes

○ White



Hermetica

HEALTHCARE &
WELLNESS/
OFFICE

Hermetic design for controlled environment rooms.

Available in two versions: square and rectangle.



Comfort and wellbeing

Exempt from photobiological risk UNE 62471.

Flicker-free: Compliance with IEEE standard 1789 -2015 LED methods and according to NEMA 77-2017 (.Pst LM<1.0 and SVM <0.6).

Prismatic diffuser: UGR<19.

Two light distributions: basic (opal) and comfort (prismatic).

Technological gradient.

3000K - 4000K.

CRI 80.



Ecodesign criteria

Efficacy up to **135lm/W**.

Made of smooth-surfaced, non-porous materials for easy cleaning and disinfection. This is important for maintaining hygiene in cleanrooms.

Sealing gasket to maintain a clean and contamination-free environment. bottom register luminaire to enable a technological upgrade.

Bottom cover with safety chain.



Ease of installation

Quick inlet and outlet connectors for ease of maintenance and reduced assembly time.

Low maintenance, reduces downtime and associated costs. This is especially important in critical environments where continuous operation is required.

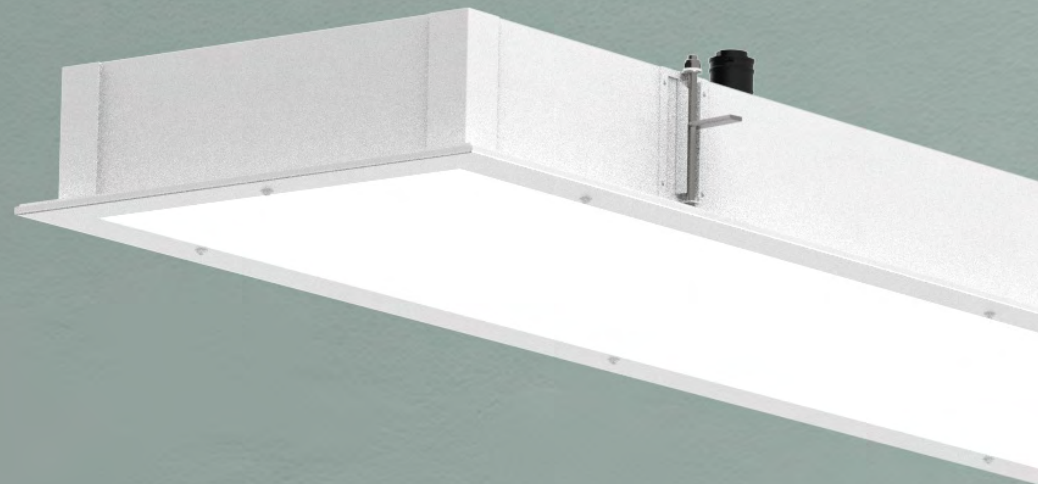



Hermetica G2

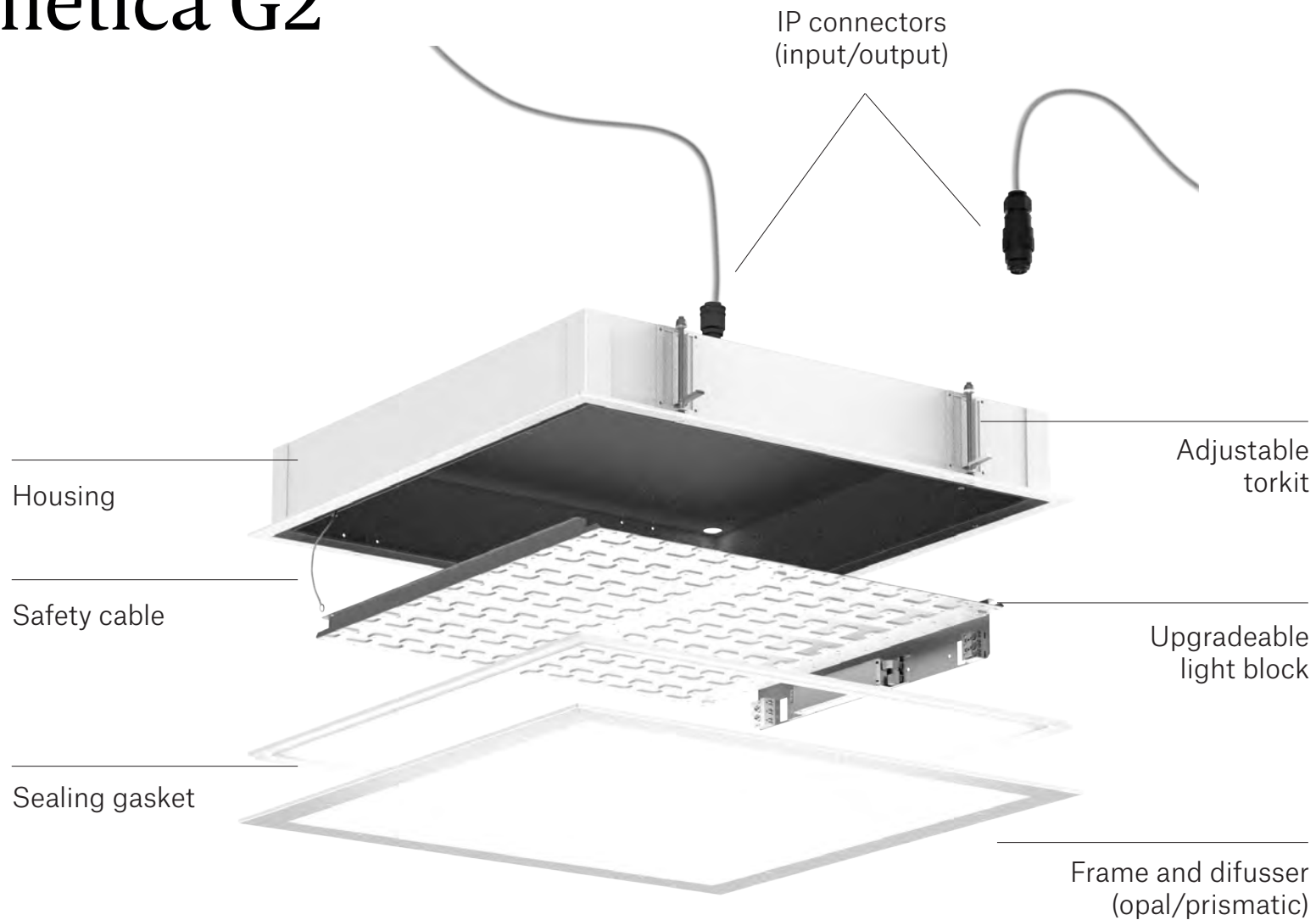

Hermetica G2

+ TECHNICAL INFORMATION

Ind.



Models

OPAL



PRISMATIC



Dimensions

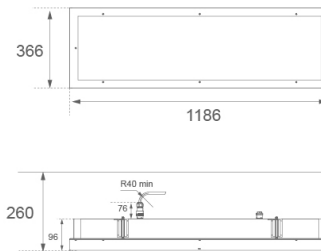
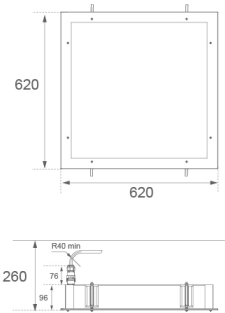

600x600mm 1200x300mm

Lm LED

5600lm

CRI

80

Beam angle



Opal



Prismatic

Color temp.

3000 / 4000

Gear

ON-OFF / DALI

IP

65

Acc. Finishes

White

NOMADIC SYSTEM

Flexible spaces, adaptable
to the new needs of each use.



NS Nomadic System



Versatile design

Lighting that adapts to the needs of architectural and lighting design.



Integration in space

Modular system that facilitates any composition and can be easily integrated into multiple types of ceilings.



Ease of installation

Simplification in the coordination of MEP and assembly installations.



Technological variety

Multiple options to cover any need.



Dynamic

Lighting system that easily adapts to special configuration changes.



Sustainability

Designed under a circular economy concept that facilitates the recovery and reuse of luminaires. Highly energy-efficient system, prioritising the use of sustainable materials.

NS Nomadic System

TRACK



+

LAMPTUB 60



STORMBELL 80



KOMBIC 100



HANCE



[+info](#)

NS Nomadic System

Versatile design and integration in space



Spaces with visible installations (without false ceiling).

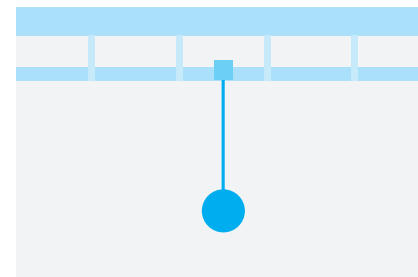

Spaces with hidden installations (continuous false ceiling).

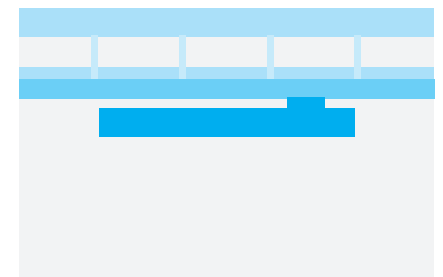

Spaces with view installations (metal tray).

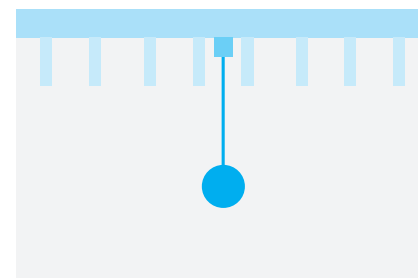

Spaces with hidden installations (slatted false ceiling).

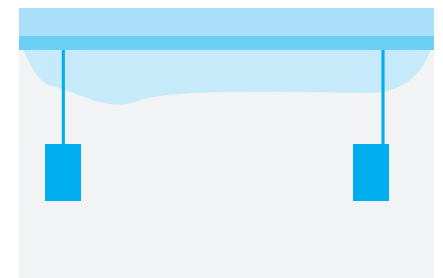

Spaces with view installations (multi-format ceilings).

NS Nomadic System



Spaces with hidden installations
(acoustic louvred false ceiling).



Refurbished spaces (integration into existing structures).

NS Nomadic System



Spaces with semi-concealed installations (large format acoustic panels).



QUIET

Portfolio of integrative solutions
lighting and acoustic comfort.

By Lamp Aistec





Integral Wellbeing Solution

Combining acoustic and lighting comfort solutions, with the highest technical specifications.



Low VOC

Low VOC emissions without formaldehyde.



Visual health

Integrated lighting solutions meet high visual comfort requirements:

Active glare control: **opal and opal comfort diffuser.**

RG0 "risk exempt" luminaires according tot the Photobiological Safety standard UNE 62471.

High visual comofrt models with large shielding angle, black reflectors and Ultra comfort optics.

Flicker free.



Adaptability and customisation

In addition to the great technical versatility of these luminaires, there is a range of 56 colours, custom finishes (die-cutting, bevelling, printing) and made-to-measure developments available.



Consultancy services

To perfectly integrate the lighting and acoustic project.



Ecodesign criteria

Designed within a circular economy concept that facilitates the recovery and reuse of luminaires. It is made of a sound-absorbing recycled PET felt non-woven fabric (from bottles). Some of the luminaires are made of recycled materials such as Aluminium or plastics.



ENVIRONMENTAL ERGONOMICS

Comfort design



Thermal comfort



Lighting comfort



Acoustic comfort

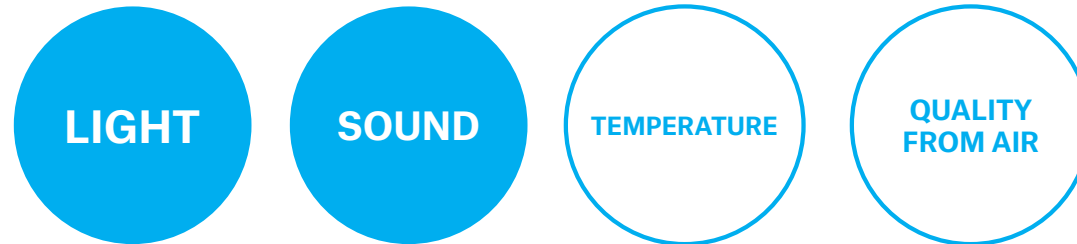



CONFIGURATOR

QUIET STANDARD

BAFFLE FIL 45



ROUND KOMBIC



SQUARE OCULT



QUIET CUSTOM

BAFFLE "DIE CUT"

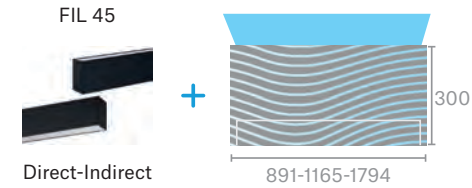

RECTANGLE CORNER

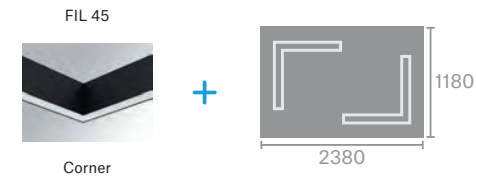

HEXAGON OCULT

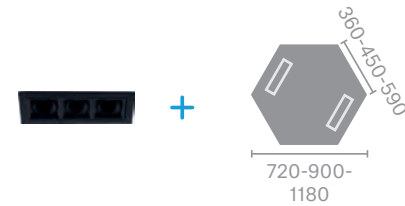



SOUND-ABSORBING PROPERTIES



rPET material

Made of 75% recycled PET plastic.



Sound absorption

α_w 0.6-0.95



VOC emissions

LOW VOC (no formaldehyde emissions)



Fire protection

B-s1, d0



Quiet Baffle Fil



FIL 45
Opal Comfort





Quiet Round Kombic



QUIET
ROUND S



KOMBIC 100
Opal W/M
Optic
Reflector B/M

QUIET
ROUND L



KOMBIC 150
Optic
Reflector B/M



790



1180



Quiet Square Ocult



Ocult

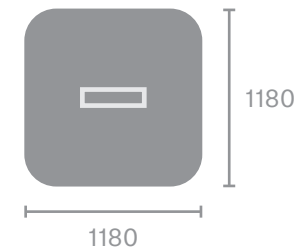



Quiet Rectangle Ocult



Ocult

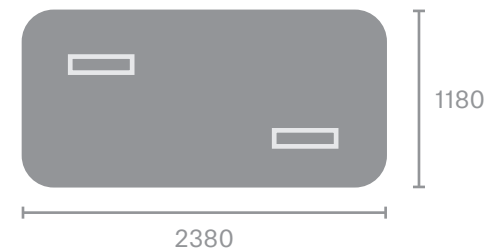



Quiet Rectangle Ocult

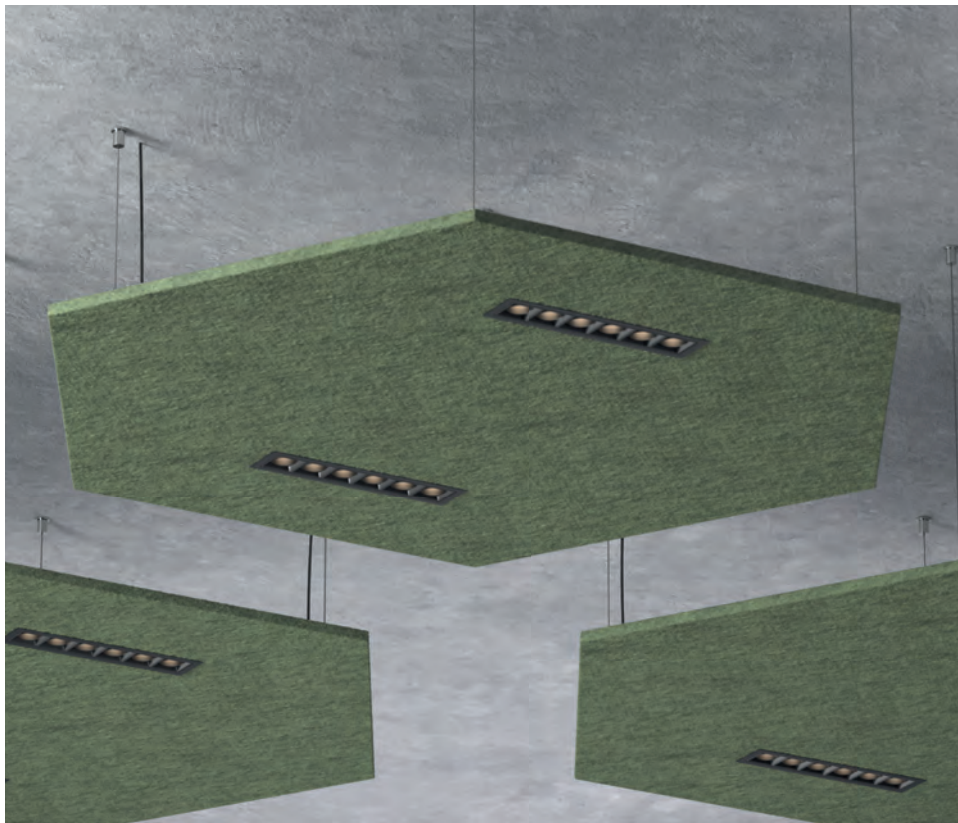

Ocult

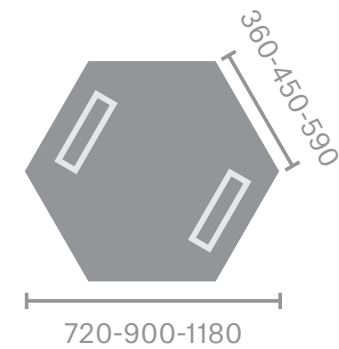



Quiet Finishes

Standard colours



K05 Charcoal



Z04 Light Camel

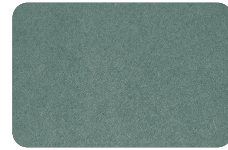

E38 Eucalyptus Green

Customizations

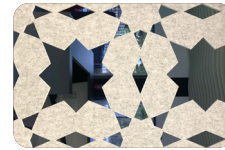

Die-cut

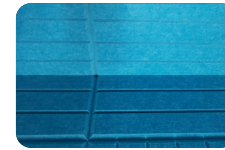

Beveled



Print

More colours available

Essential Colours

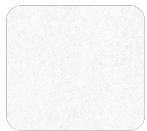

Z07 White



Z92 Natural Almond



Z04 Light Camel



Z12 Dark Camel



Z98 Slate Green



E38 Eucalyptus Green



K14 Lake Blue



Z14 Light Blue



Z19 Navy Blue

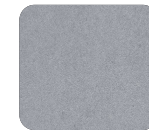

Z30 Water Grey



K13 Black



K05 Charcoal



Z11 Marble Grey



Z05 Apricot



Z46 Orange



Z08 Crimson



Z24 Bordeaux



E87 Light Salmon

Prime Colours



A101 Marble Light



A202 Pale Brown



A027 Light Green

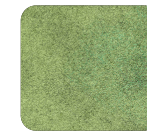

A220 Mint Green



A099 Aqua



A224 Malachite Blue

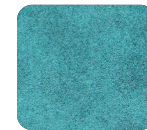

A222 Dark Turquoise

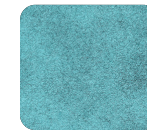

A208 Blue Haze

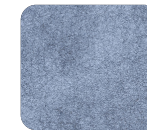

A227 Lotus Blue



A226 Sunset



A219 Rust Red



A206 Litmus Red



A026 Lilacy



A029 Taro Purple



QUIET FINISHES

More colours available

Trendy Colours



K02 Creamy White



E16 Vanilla

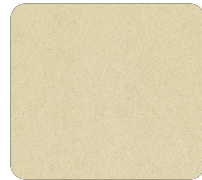

E14 Light Brown



Z90 Taupe



K09 Khaki



Z32 Brown



Z28 Gold Bronze

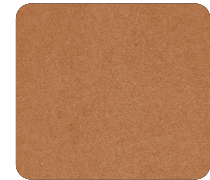

Z41 Milk Coffee



E23 Acorn Brown



E35 Dark Coffee

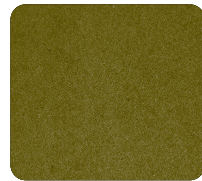

K15 Mustard

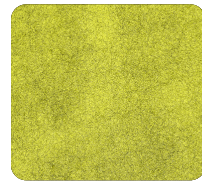

K20 Honeybee
Yellow



Z43 Pistachio



K16 Peppermint

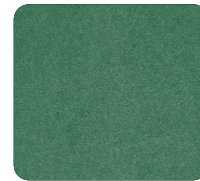

Z10 Grass Green



Z97 Cactus Green



E30 Forest Green



E51 Saiyan God
Blue

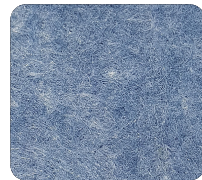

Z25 Sky Blue



Z96 Cerulean

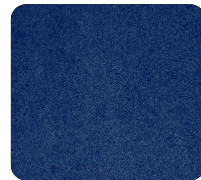

K08 Royal Blue



Z93 Blue Indigo



Z37 African Grey

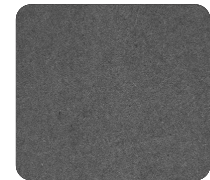

Z36 Moonlight
Grey



K04 Silver Grey



Z91 Soft Grey



Z95 Goldenrod



E28 Candy Red



K06 Vermillion



E34 Hot Chili



Z94 Burgundy



Z49 Lavender

HANCE BIOPHILIA

Design by Lamp





Biophilic design

~ Biophilia: psychological trend to be attracted to everything living and vital ~

Biophilic design seeks to foster the innate connection between humans and nature within the project, helping to create healthier and more comfortable spaces by integrating organic components and natural materials. Practice included in some specialised standards in the generation of healthy spaces

Benefits of vertical gardens

- **Air purification.** Removing up to 85% of toxic agents from the air, such as benzene, formaldehyde and trichloroethylene.
- **Thermal Insulation.** Reducing temperatures in hot weather and maintaining the interior case in cold weather.
- **Acoustic Isolation.** Absorbs up to 10 dB of ambient noise.
- **Improves users' sense of well-being and comfort.** Contributes to creating greener urban landscapes, having a positive impact on biodiversity, climate change and mitigating the heat island effect of cities.





Optimised light spectrum for vegetation lighting.

- "Full Spectrum"
- CRI up to 85
- CCT (approximate) 2700K
- Lighting option for 'Plant Growth' or 'Generative Growth (Flowering)'
- Flux: Up to 177 $\mu\text{mol/s}$
- Efficiency: 2.7 $\mu\text{mol/J}$
- Luminous distribution: FL (37°), MFL(24°), Elliptical

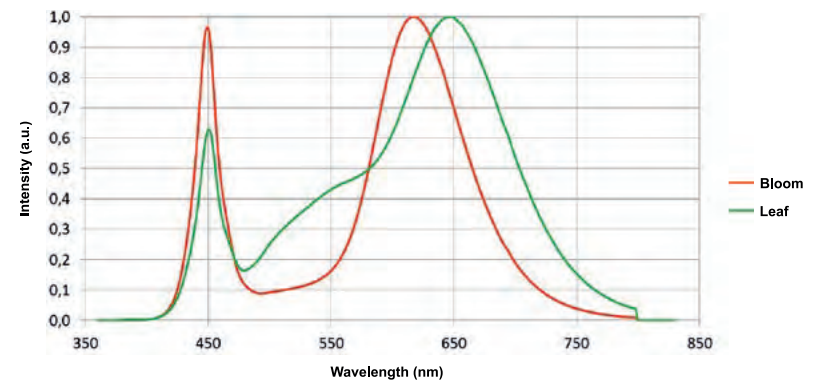

*Light source data



OTHER LUMINAIRES AVAILABLE

Consult other models compatible with the lighting of plant ecosystems, such as linear luminaires or luminaires of great heights.

HANCE
DOWNLIGHT

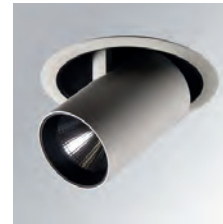

KOMBIC



STORMBELL



IMAG



FIL



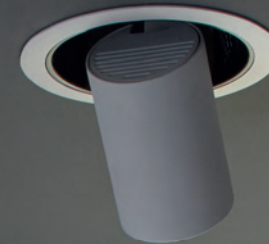

Hance Downlight

"Endless possibilities"

High performance, sophisticated style and versatility in a recessed lighting solution that exceeds your expectations. Design based on flexibility within retail spaces, a new family of accent lighting is born, characterised by its wide range and application.

Design by Lamp





High efficiency and variety of lighting options

- Maximum energy efficiency, up to 165lm/W.
- Available in different color temperatures, (3000-4000K) and high color rendering (CRI90), offers great variety of opening angles to adapt to the needs of lighting: super spot (10°), spot (20°), medium flood (25°) and flood (35°).

High flow recessed solutions

Downlights designed in a variety of sizes and fluxes bright, from 975 lm to 4,100 real lm.

- **Integrated model**
With a rotation of 355° and inclination from 0° to 30°, for applications where the product goes unnoticed and is seeks maximum integration in space.
- **Semi-recessed model**
With a rotation of 355° and inclination from 0° to 85°, for applications with higher requirements light direction. Fix lighting shelves where uniformity is required throughout the vertical plane.



Variety of finishes and additional accessories

Interchangeable and customizable rings that allow you to incorporate various optical accessories in an integrated way and adapt to the lighting requirements with coherence and meaning in space.

Finishes: The body available in two standard finishes: black and white, incorporating an anti-glare ring black, also available in metallic copper, silver and white.

Wide range of lighting accessories: elliptical lenses, lenses soft, anti-glare honeycomb grilles and trimmers



Models	REC 1000/2000	SEMI-REC 1000/2000	REC 3000/4000	SEMI-REC 3000/4000
Dimensions				
Lm LED	1000 lm - 2000 lm		3000 lm - 4000 lm	
CRI	80 / 90			
Beam angle				
Color temp.	2700 / 3000 / 4000 K			
Gear	ON/OFF - DALI			
Power	7 - 18 W		25 - 35 W	
Finishes	● Black 03	○ White 03		
Acc. Finishes	● Black 03	○ White 03	● Silver Metalized	● Copper Metalized



Recessed

1000 / 2000 Lm LED - 64 models

3000 / 4000 Lm LED - 48 models

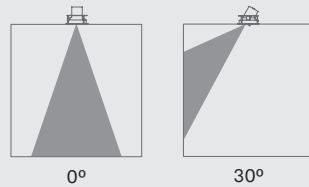

With a rotation of between 0° to 30° for when the product needs to be hidden and maximum spatial integration is needed.

Semi-Recessed

1000 / 2000 Lm LED - 64 models

3000 / 4000 Lm LED - 48 models

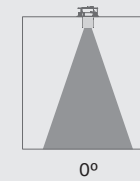
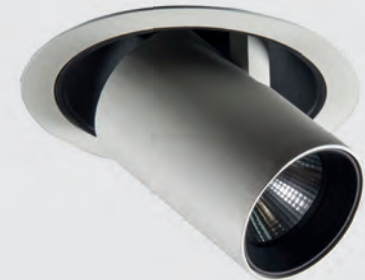
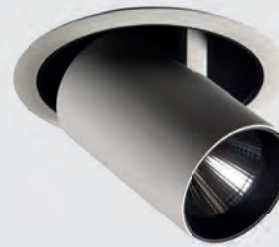

With a rotation of between 0° to 85° for larger lighting direction requirements. For shelf lighting that requires an even distribution of light along vertical surfaces.

+ TECHNICAL INFORMATION

Ind.





Hance Spotlight

"Endless possibilities"

Designed with flexibility in mind, Hance Spotlight is the perfect choice for retail and exhibition lighting. With an enhanced efficiency of 127lm/W, this family of accent lighting stands out for its versatility and applicability in a variety of environments. We are committed to technological innovation and look forward to an infinite horizon of possibilities.

Design by Lamp

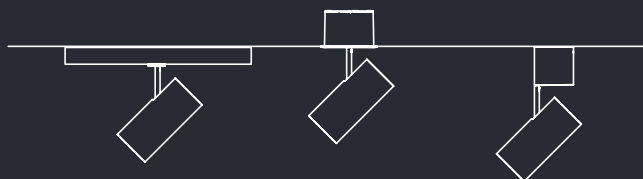



Responsive Designed

Our spotlight projectors are available in three installation options: **track, surface or semi-recessed, (355° rotation and inclination from 0° to 90°)** providing versatility in your installation. Furthermore, the family is complemented with their downlight versions.

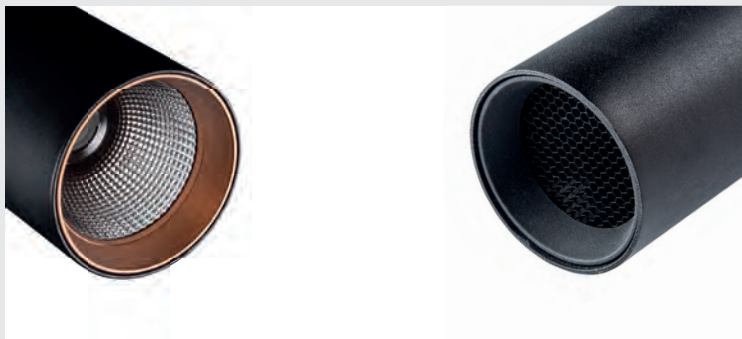

Variety of finishes and accessories

Finishes: The body is available in two standard finishes elegant: textured black and white, incorporating an anti-glare ring black, also available in metallic copper, silver and white.

Wide range of lighting accessories: elliptical lenses, lenses soft, honeycomb anti-glare grilles and trimmers.

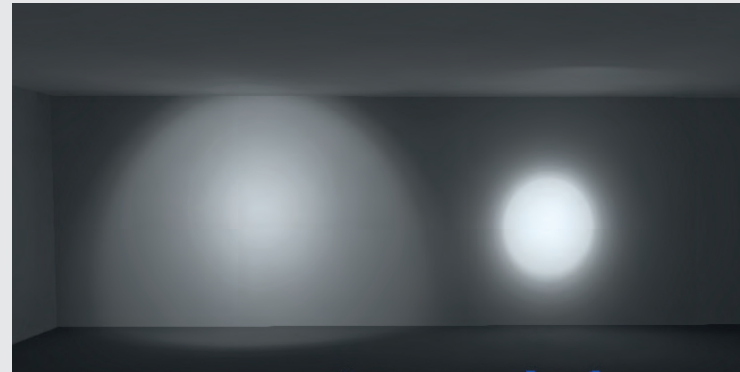

High efficiency and variety of lighting options

- Maximum energy efficiency, up to 108lm/W.
- Available in different color temperatures, (3000-4000K) and high color rendering (CRI80-90), offers wide variety of opening angles to adapt to the lighting needs: super spot (10°), spot (20°), medium flood (25°) and flood (35°).



Integration with space

Models with 48V rail installation that seek maximum integration in space with a miniaturized design and little intrusive with the environment.

Hance Spotlight | Indoor

+ TECHNICAL INFORMATION

Ind.



Models	1000	2000	3000	4000
Dimensions Track				
Dimensions Surface Semi-Recessed				
Lm LED	1000 lm	2000 lm	3000 lm	4000 lm
CRI	80 / 90			
Beam angle	SSP 10° SP 16°-17° MFL 23°-24° FL 36°-37°		SP 16° MFL 23° FL 34°	
Color temp.	3000 / 4000 K			
Gear	ON/OFF - DALI			
Power	7 W	18 W	25 W	35 W
Finishes	● Black 03 ○ White 03			
Acc. Finishes	● Black	○ White	● Silver Metalized	● Copper Metalized

Hance 1000 Lm





Hance Spotlight Family

HANCE TRACK

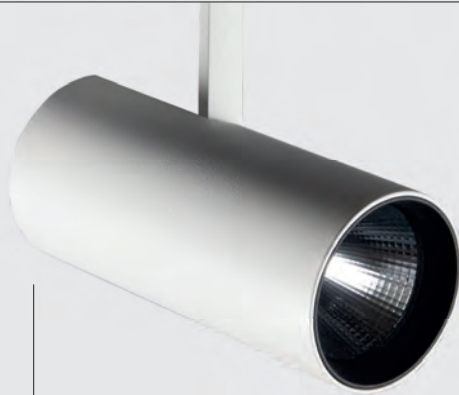

LM LED
3000 - 4000
144 models •
Track / Surface / Semi- recessed

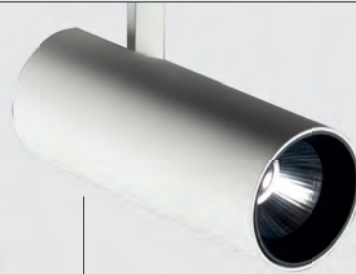

LM LED
2000
84 models •
Track / Surface / Semi- recessed

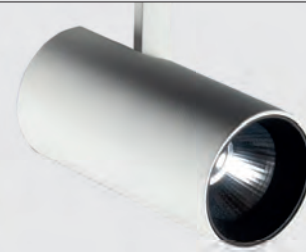

LM LED
1000
84 models •
Track / Surface / Semi- recessed

HANCE SURFACE



HANCE SEMI-RECESSED

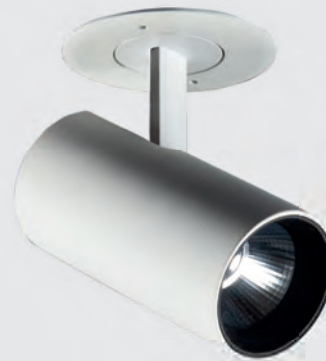

+ TECHNICAL INFORMATION

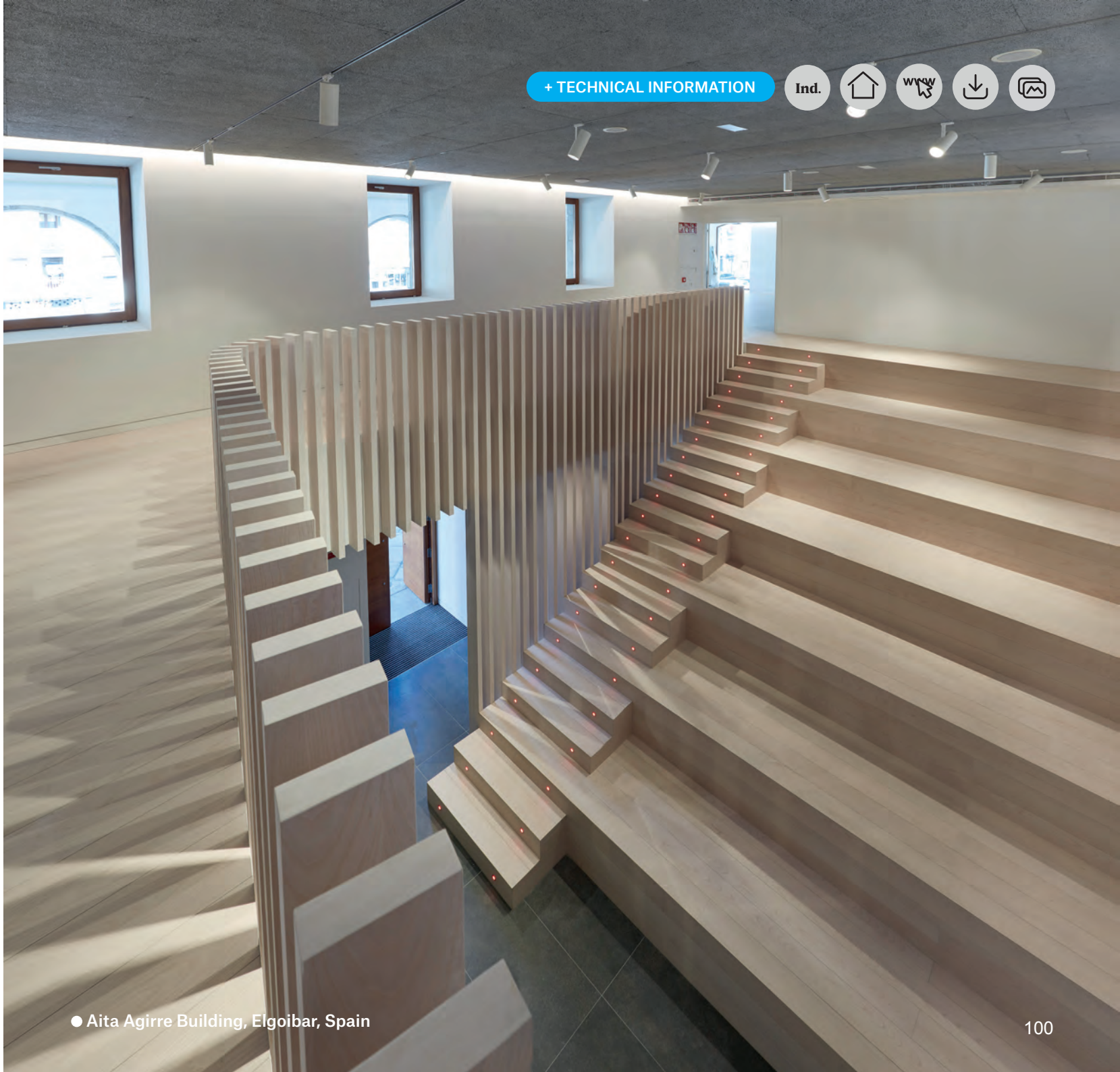



Hance 48V

"The importance of details"

The miniaturisation of this spotlight plays a key role within the Hance product family. It speaks directly to those users who know that details matter, as it blends in perfectly with the most demanding spaces thanks to its wide range of finishes.

Design by Lamp

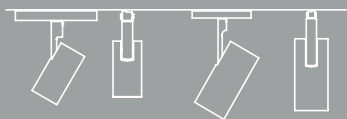

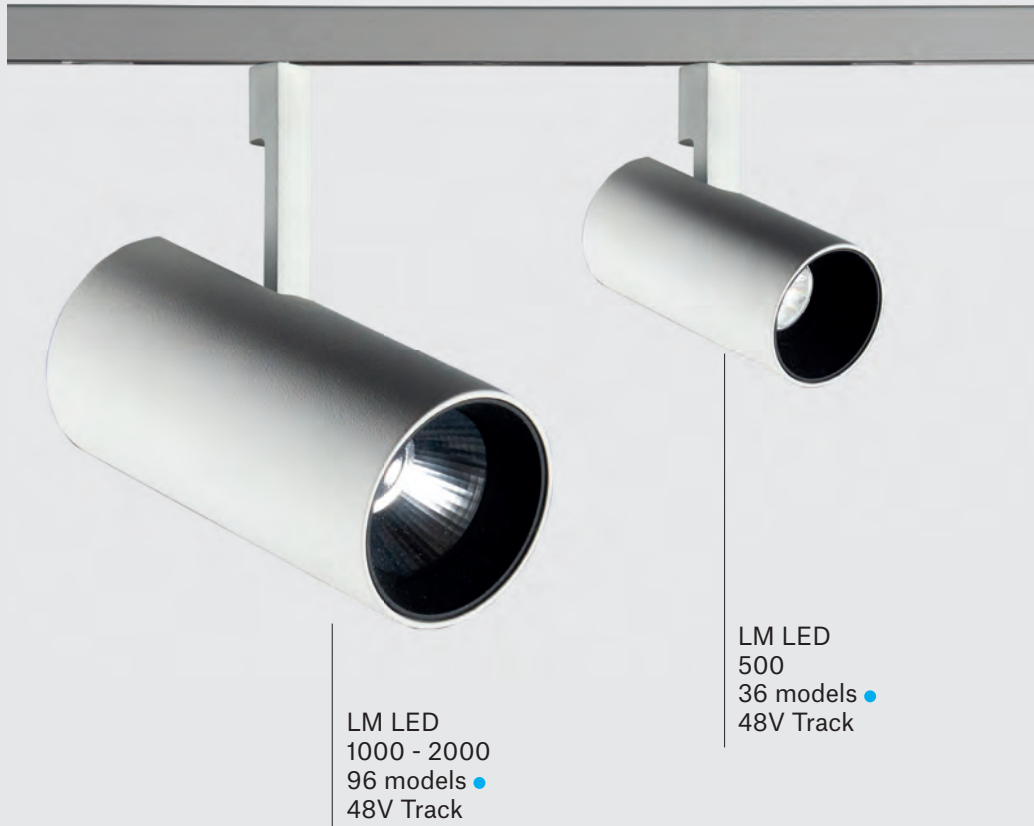

LM LED
1000 - 2000
96 models ●
48V Track

LM LED
500
36 models ●
48V Track

Applications

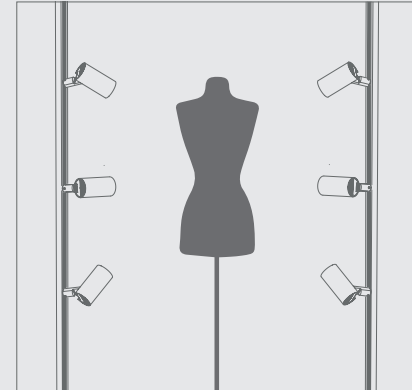

Displays

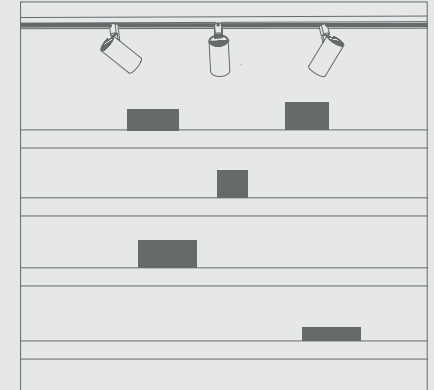

Shelving

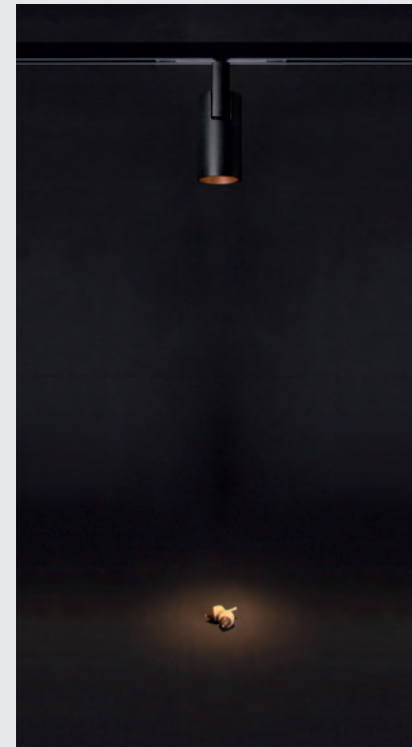

Models

500



1000/2000



Dimensions

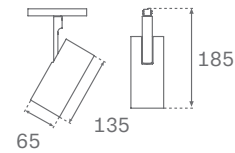
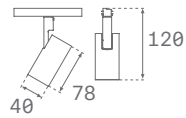

Lm LED

500 lm

1000 lm - 2000 lm

CRI

80

Beam angle

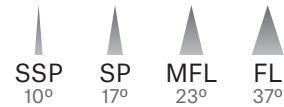

Color temp.

2700 / 3000 / 4000 K

Gear

ON/OFF - DALI

Power

5 W

8 - 18 W

Finishes

● Black 03 ○ White 03

Acc. Finishes

● Black ○ White ● Silver Metalized ● Copper Metalized

Hance 48V

+ TECHNICAL INFORMATION

Ind.



Lamp Worktitude for light

● Croma by Flash Restaurant, Barcelona, Spain

Ocult Downlight

“Versatile lighting with the highest comfort”

A modular downlight concept has been created with visual comfort as its design starting point, offering excellent lighting versatility under minimal formal expression, with the possibility to choose between accent or general lighting, as well as a wide variety of lengths, modular layouts and finishes.

Design by Lamp

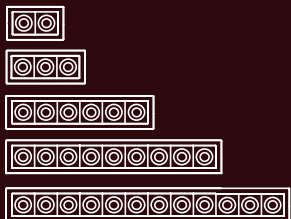

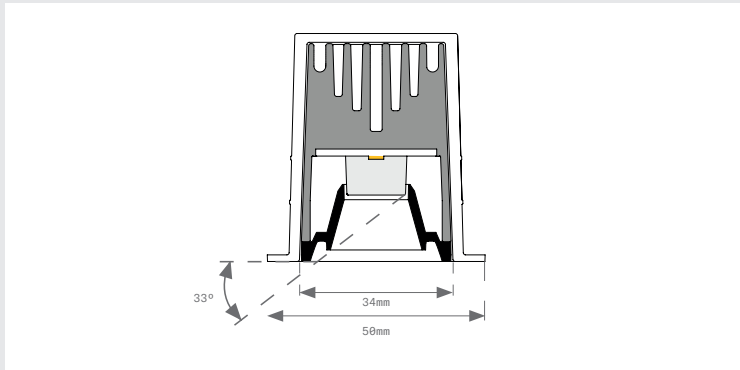

High visual comfort

The optical design is carried out by means of a lens and a 33° cut off, making it possible to offer a high visual comfort with a <math><19</math> or <math><15</math> UGR (for 4H, 8H 70/50/20) depending on the optics.

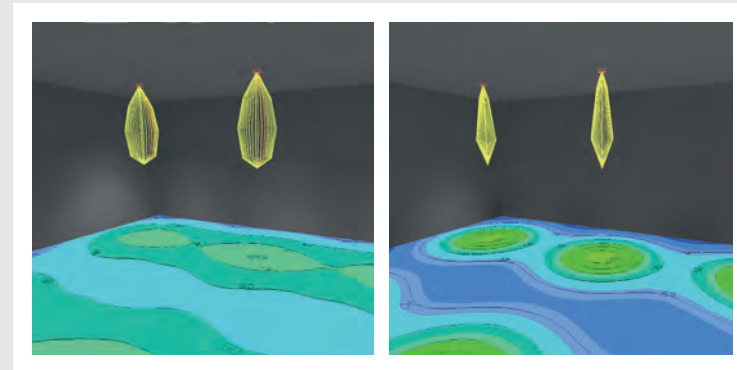

Versatility in lighting applications

Thanks to its wide range of flows and openings: MFL (24°) and WFL (48°) it can be used both for general lighting spaces with a uniform light, and for hospitality spaces where contrasts of light are required.



Link with interior design

The interchangeable front trim system makes it possible to link light aesthetics with context, and offers trimless solutions for less impact on space.

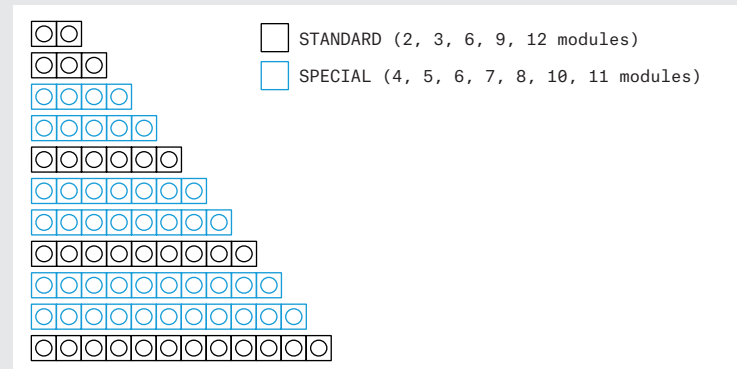

Customisable length

Its technical concept enables for the customisation of its length to better adapt to the specific needs of each project.

Ocult Downlight | Indoor

+ TECHNICAL INFORMATION

Ind.



Models	2 MODULES	3 MODULES	6 MODULES	9 MODULES	12 MODULES
Dimensions Frame					
Dimensions Trimless					
Lm LED	400 lm	600 lm	1200 lm	1800 lm	2400 lm
CRI	80				
Beam angle					
Color temp.	3000 / 4000 K				
Gear	ON/OFF - DALI				
Power	4 W	6 W	12 W	18 W	24 W
Finishes	● Black 03	○ White 03			
Acc. Finishes	○ White 03	● Silver Metalized	● Copper Metalized		

+ TECHNICAL INFORMATION



Installation Frame



Extruded heat sink body
Allows modularity



PCB with HI-POWER LED

3000K - CRI80
4000K - CRI80

Optics



High glare comfort reflector

- White
- Black
- Silver Metallized
- Copper Metallized

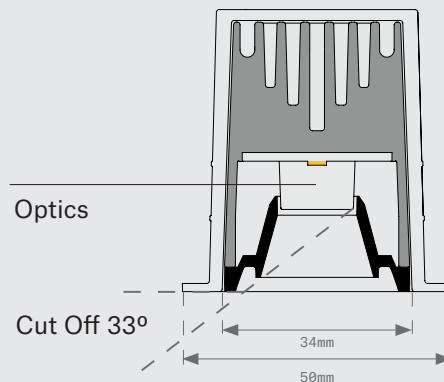



Installation

Frame

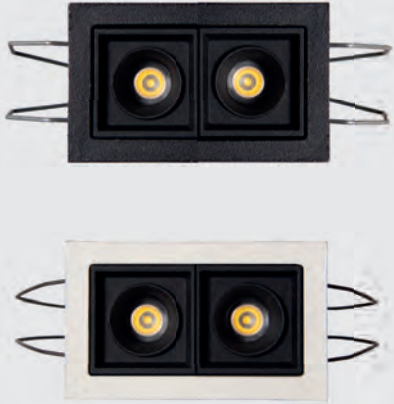

Trimless



Finishes

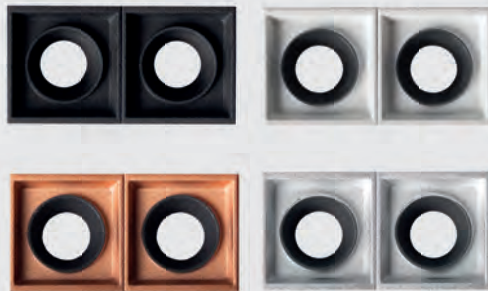

Modulation





Ocult System

"Imagine the solution, we'll make it happen"

The multiple needs that can arise in a versatile and multipurpose space, solved in a simple yet elegant way: A system that makes it possible to create accent lighting or general lighting thanks to the integration of modular downlight, suspended luminaires, or projectors. Imagine the solution, we'll make it happen.

Design by Lamp

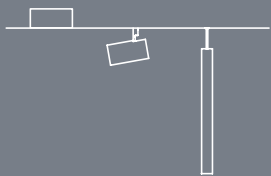



Configuration



Web configurator

1. Installation

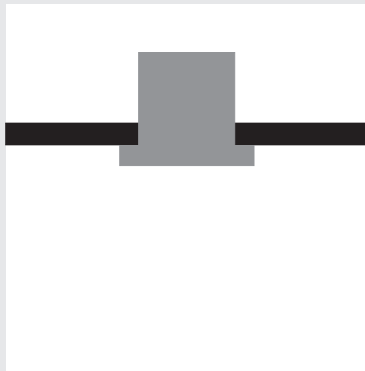

Recessed

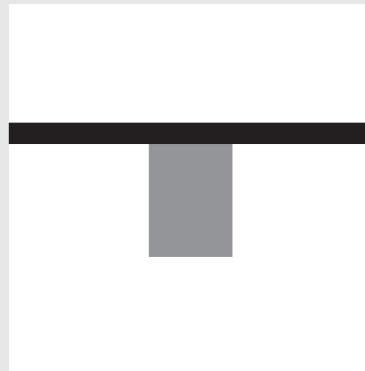

Surface

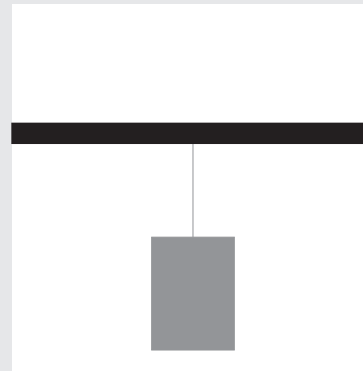

Suspended

2. Format



Linear



Corner

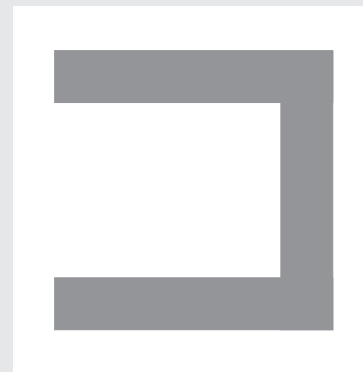

U Format

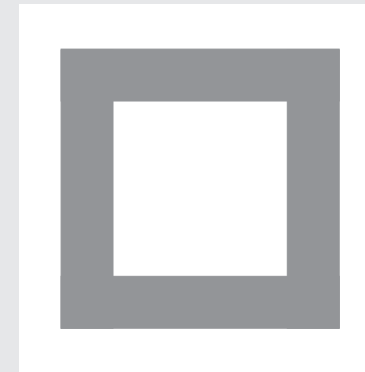

Square



Customizable



3. Light Modules

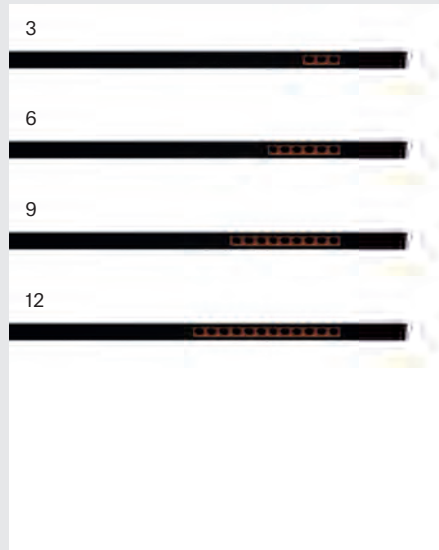

Downlight



Spotlight



Pendular

4. Accessories

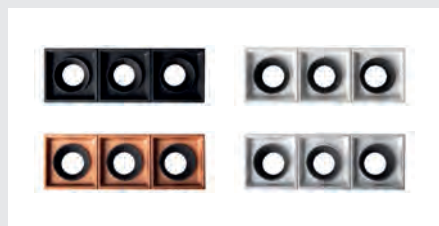

Downlight

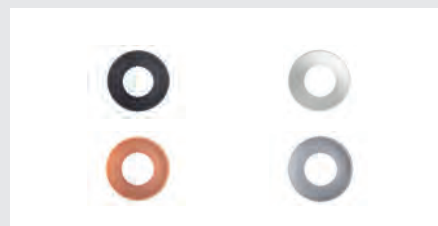

Spotlight

5. Solution





Application versatility

It offers solutions for vertical and horizontal planes within the same system, with solutions for accent, general, and hanging lightning.



Retractable lid

The lid's double height enables a better integration of the components in the profile, as well as a reduction of the product's impact within the space.



Formal consistency

All the system components can be combined with their cylindrical and miniaturised format within the same formal consistency and with decorative accessories with different finishes that enable their customisation.

Models	DOWNLIGHT	SPOTLIGHT 500	SPOTLIGHT 1000	PENDULAR
Dimensions				
Lm LED	600 lm - 2400 lm	500 lm	500 lm - 1000 lm	500 lm
CRI	80			
Beam angle	MFL 24° WFL 48°	SP 13° MFL 19° FL 26°	SSP 10° SP 17° MFL 23° FL 37°	SP 17° FL 39°
Color temp.	3000 / 4000 K			
Gear	ON/OFF - DALI			
Power	6 - 24 W	5 W	8 - 9 W	4 W
Finishes	● Black 02			
Acc. Finishes	● Black 02 ○ White 02	● Silver Metalized	● Copper Metalized	● Black 03 ○ White 05

Ocult System

+ TECHNICAL INFORMATION

Ind.

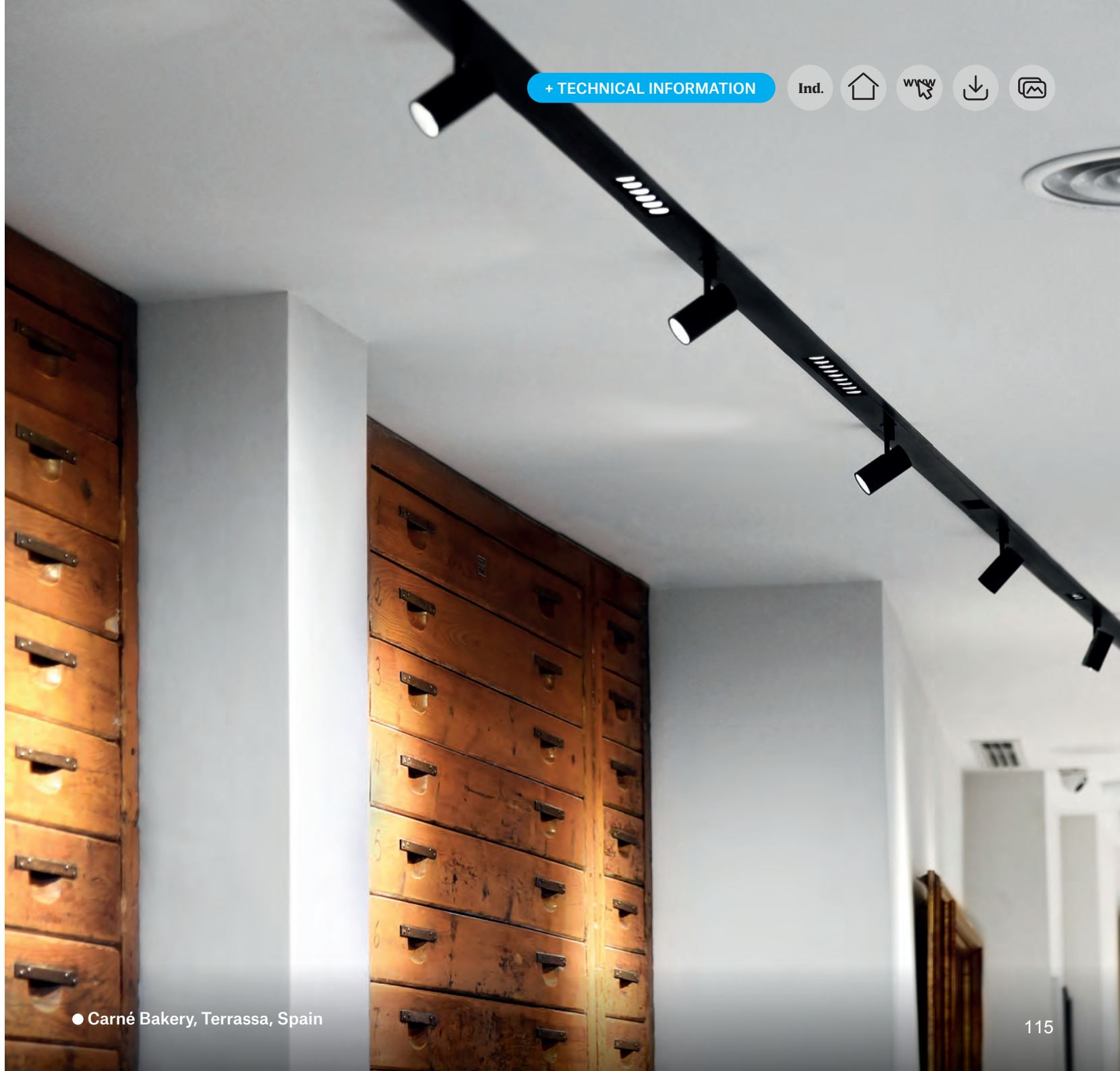



Imag

"Functionality and technology"

With a neutral design, Imag combines technological improvements with the performance of its best predecessors. It is a product in constant technical evolution.

Design by Lamp

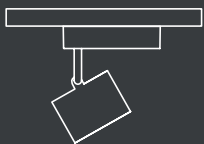



Models

TRACK



Dimensions

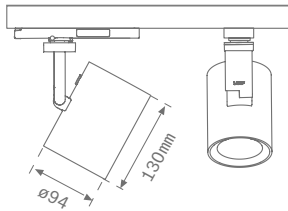

Lm LED	2000 lm - 4000 lm
CRI	90
Beam angle	
Color temp.	3000 / 4000 K
Gear	ON/OFF
Power	14 - 37 W
Finishes	● Black 05 ○ White 05

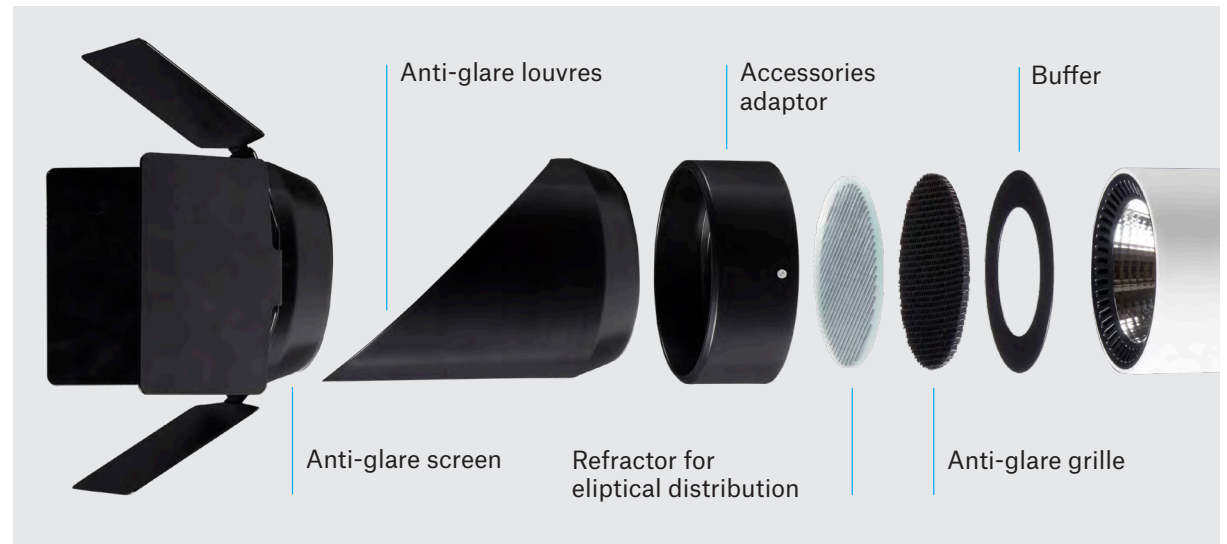

+ TECHNICAL INFORMATION

Ind.

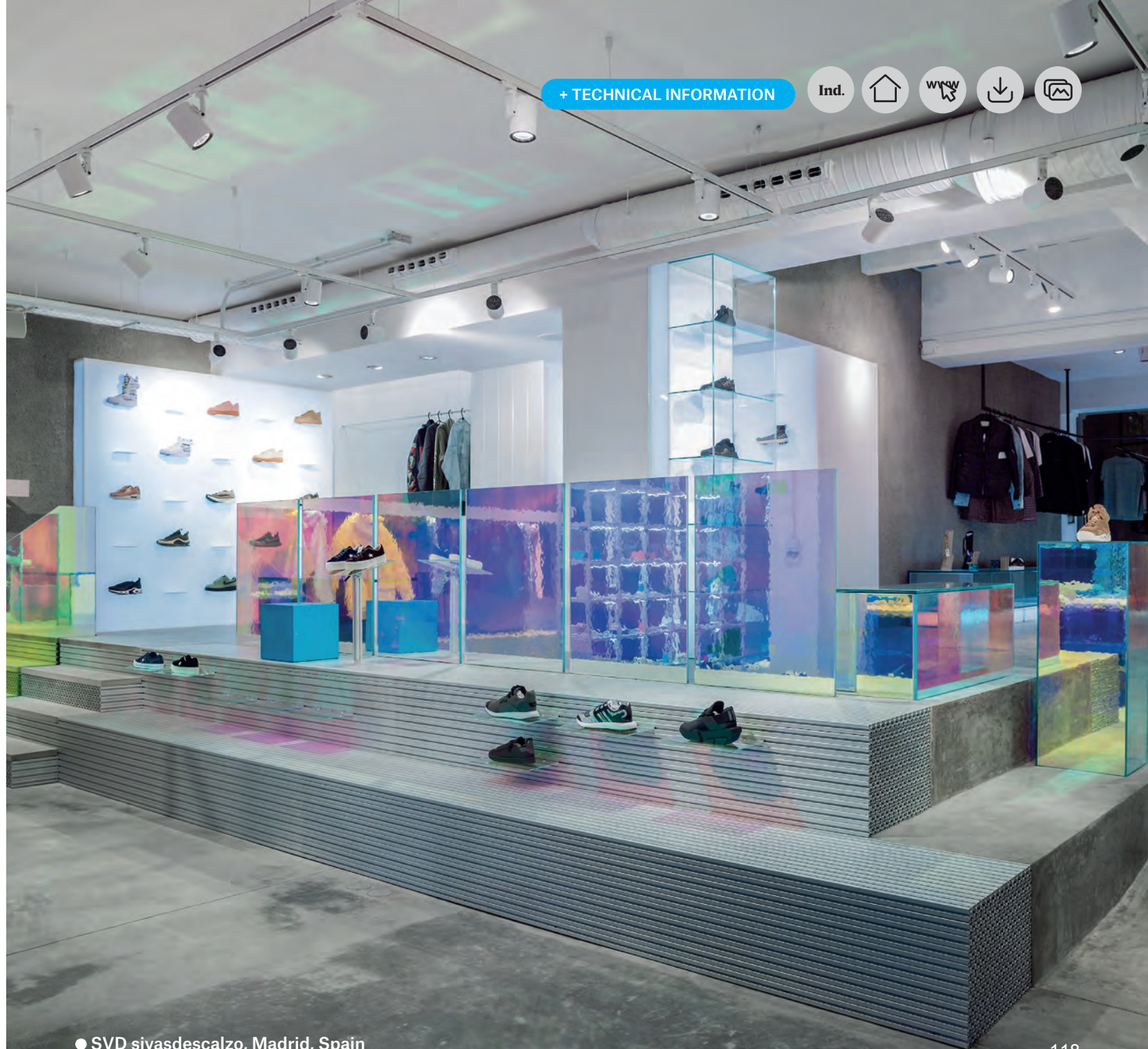

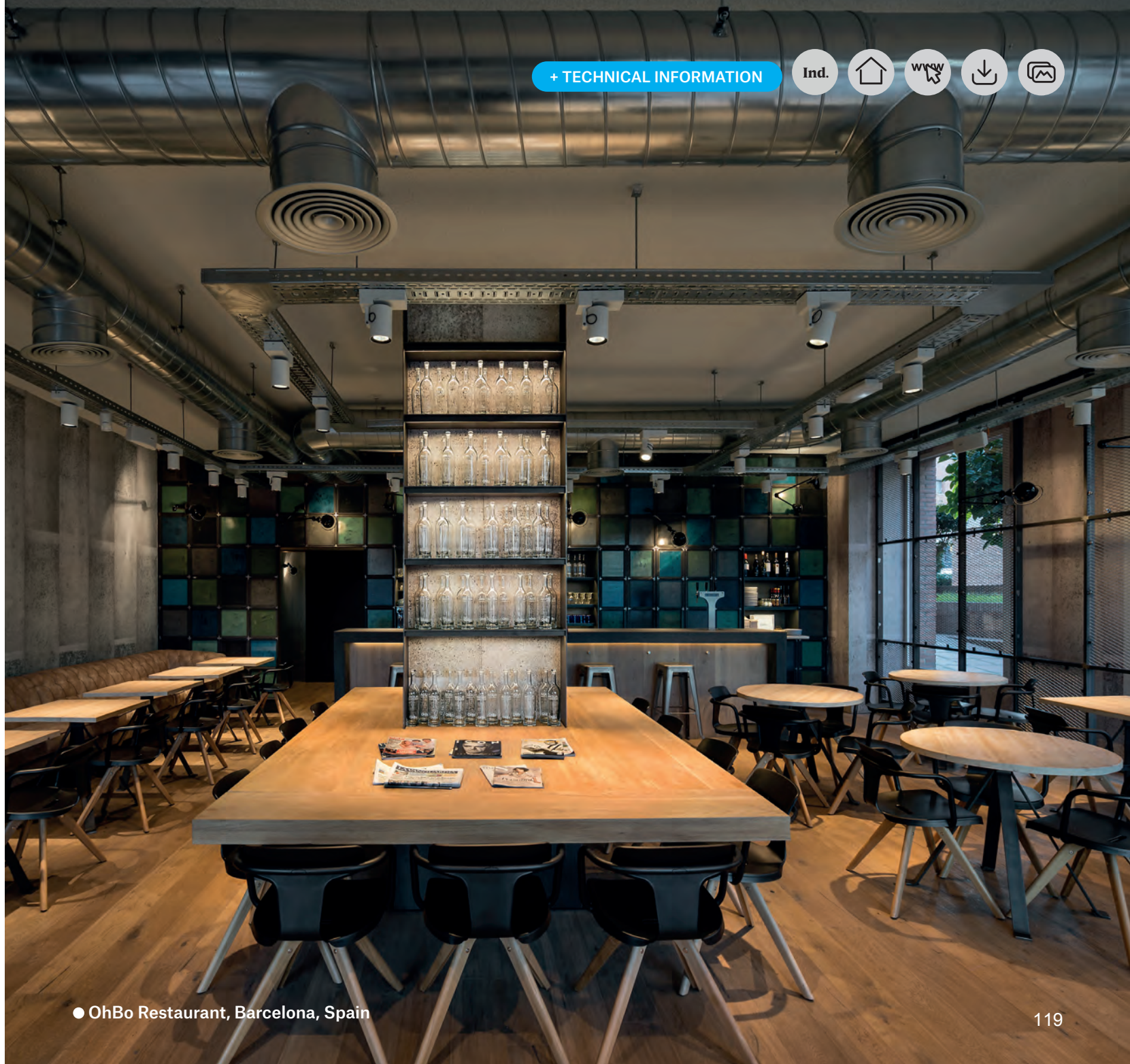

+ TECHNICAL INFORMATION





Ind.



Kombic

"Lighting versatility and high visual comfort in a compact design"

Kombic is reborn in a new design, to become a more versatile family. This compact design offers multiple installation and finishes, as well as a wide variety of luminous flux and optical features.



Design by Lamp

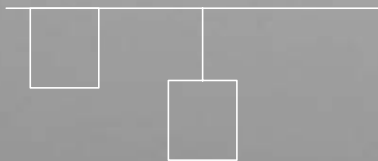



Kombic 70

Downlight



Surface



Kombic 100

Downlight



Surface



Kombic 150

Downlight



Surface



Kombic 200

Downlight

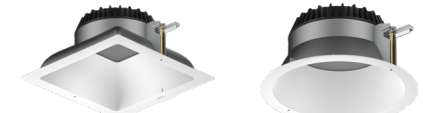

Surface



Optic

Basic **Comfort** **Efficiency**

Opal 54° Optic WF 52° Elliptic Wall Washer (WW) RF 33° RW 52°



Optic

Basic **Comfort** **Efficiency**

Opal 67° Optic WF 52° Elliptic Wall Washer (WW) RF 33° RW 60°

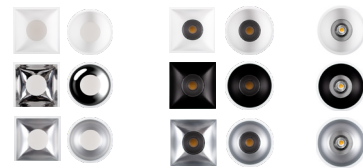

Optic

Basic **Comfort** **Efficiency**

Opal 66° Optic WF 61° Elliptic Wall Washer (WW) RF 33° RW 60°



Optic

Basic

Opal 66°



Finishes



Finishes downlight & surface

Finishes



Finishes downlight & surface

Finishes



Finishes



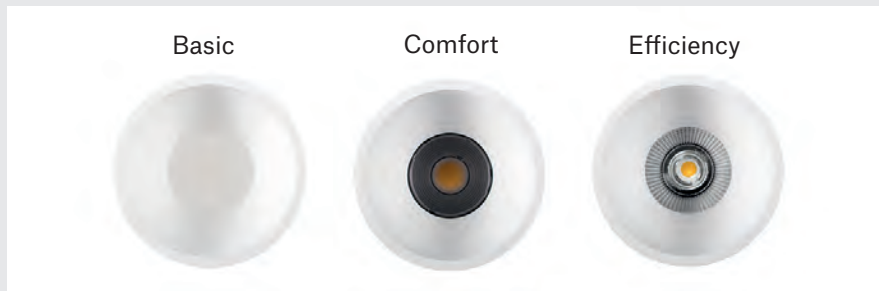

Three versions incorporated in single solution to solve multiple applications:

Basic: Opal model, for general lighting.

Comfort: Model with optics, UGR <16 and efficiency up to 107.60lm output/W.

Efficiency: Model with reflector, different apertures. UGR <19, and efficiencies up to 130 lm output/W.



Versatility of applications: possibility of recessed, surface, suspended and nomadic system version (adaptation tot electrified rail) installation.



Reflector made of recycled polycarbonate R-PC WHITE™ with bromine-free flame retardant. Flammability grade V0 according to UL94.

Environmental declarations based on the UNE 15804 standard, which quantifies the **impact on the carbon footprint** throughout its life cycle.

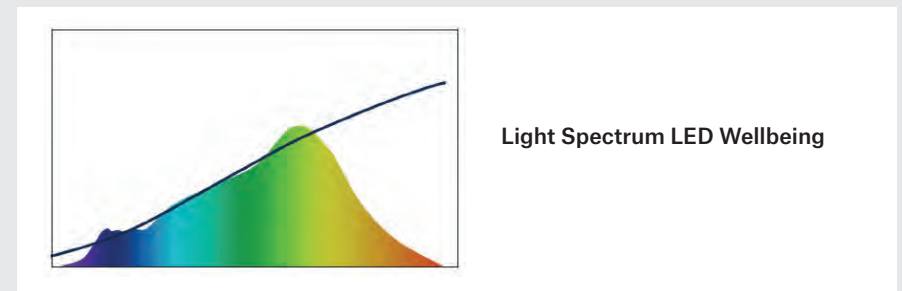

A wide variety of technologies available in the same family, incorporating models with **Wellbeing technology**.

New Elliptic and WallWasher optics for the family:

Elliptic optics optimizes light distribution. This luminaire allows to increase the distance between luminaires, reducing the effect of residual light on the walls. Ideal for illuminating passageways, longitudinal areas such as counters and spaces adjacent to work areas.

Available for Kombic 70, 100 and 150.

Wallwasher optics for control of light distribution to the vertical surface without dark areas.

Available for Kombic 70, 100 and 150.

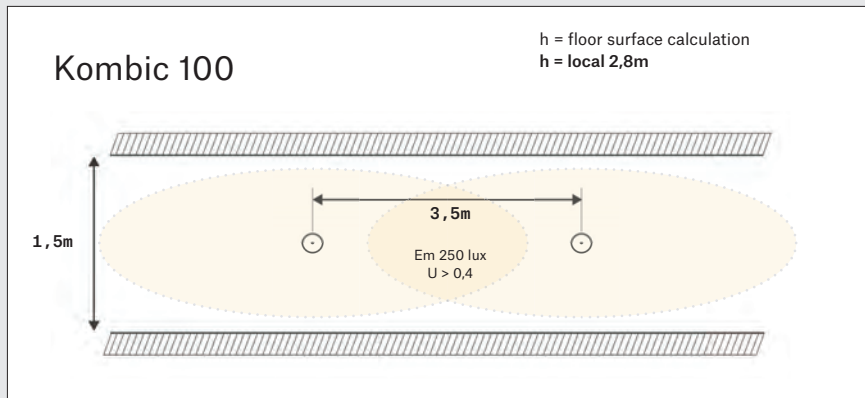
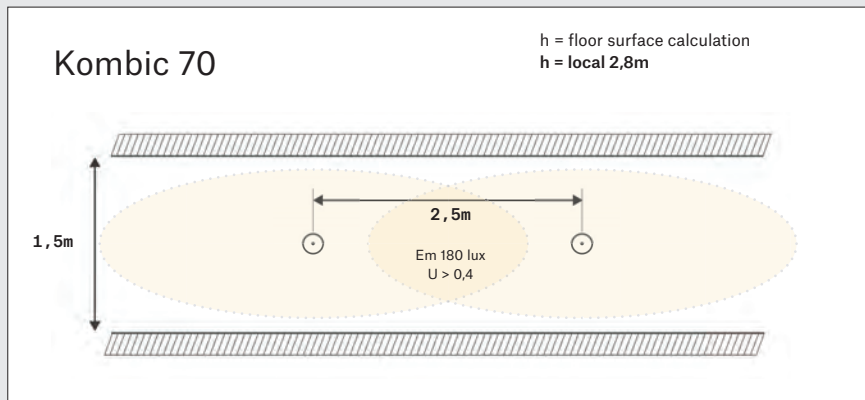

Examples recommended installation scheme in **pass-trough areas**

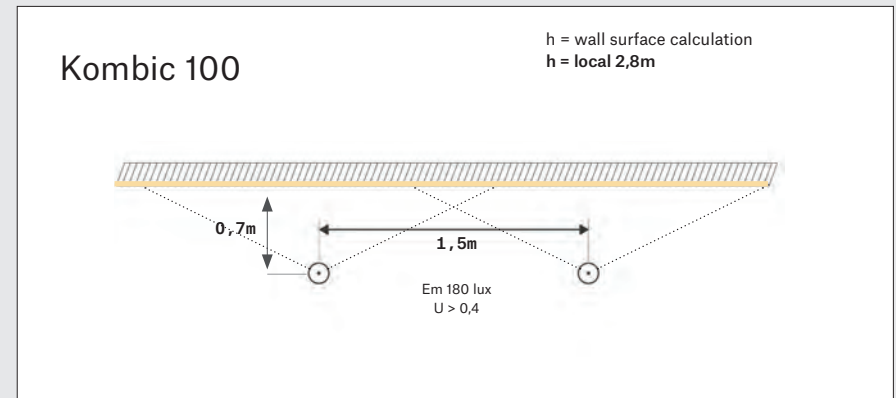
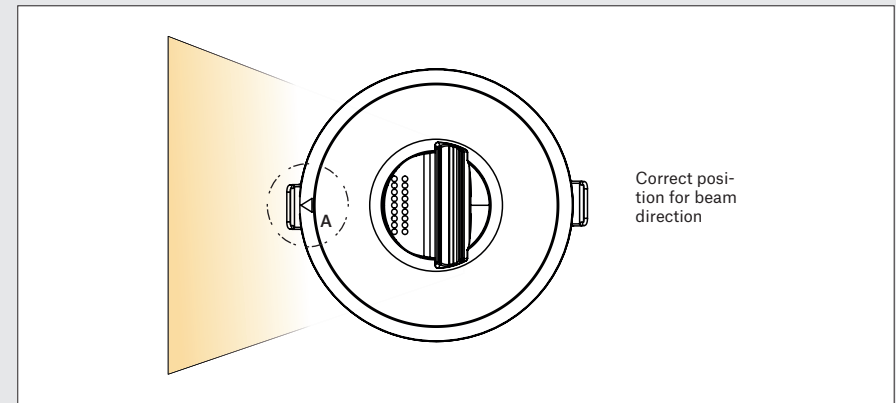

Examples recommended installation scheme in **pass-trough areas**



Models	DOWNLIGHT 70	DOWNLIGHT 100	DOWNLIGHT 150	DOWNLIGHT 200	SURFACE 70	SURFACE 100	SURFACE 150	SURFACE 200
Dimensions								
Lm LED	1500lm	2000-2500lm	2000-3500lm	3000-5000lm	1500lm	2000-2500lm	2000-2500lm	3000-5000lm
IP	BASIC IP43 IP44 IP65 COMFORT & EFFICIENCY IP43	BASIC IP43 IP44 IP65 COMFORT & EFFICIENCY IP43	BASIC IP43 IP44 IP65 COMFORT & EFFICIENCY IP43	BASIC IP43 IP44 IP65 COMFORT & EFFICIENCY IP43	BASIC IP20 COMFORT & EFFICIENCY IP43	BASIC IP43 IP44 IP65 COMFORT & EFFICIENCY IP43	BASIC IP43 IP44 IP65 COMFORT & EFFICIENCY IP43	BASIC IP43 IP44 IP65 COMFORT & EFFICIENCY IP43
IRC / CRI	80-90	80-90	80-90	80-90	80-90	80-90	80-90	80-90
Beam angle								
			OPAL	OPTIC	ELLIPTIC	WALLWASHER	REFLECTOR	
Temp.color	2700-3000-4000K	2700-3000-4000K Tunable White Wellbeing	2700-3000-4000K Tunable White Wellbeing	3000-4000K	2700-3000-4000K	2700-3000-4000K Tunable White Wellbeing	2700-3000-4000K Tunable White Wellbeing	3000-4000K
Gear	ON-OFF / DALI							
Power	8,4W	12-18W	12-25W	17-36W	9,5W	12-18W	12-25W	17-36W
Finishes								

KOMBIC 70 DOWNLIGHT

Technical demands and light adaptability in a compact volume

Downlight with a demanding technical performance to meet different lighting requirements, by means of a miniaturised and compact volume.

Design by Lamp



Kombic 70 Downlight





Downlight with a demanding technical performance to meet different lighting requirements, by means of a miniaturised and compact volume.

Main application segments:

**OFFICE/
EDUCATION**
Comfort
Efficiency

**COMMON
SPACES**
Basic
Efficiency

**HEALTHCARE
& WELLNESS**
Basic
Comfort

Three versions fitted into a single solution to solve multiple applications:

BASIC
Opal model, for general lighting.

COMFORT
Model with optics (52°), UGR <16 and efficiency up to 107,60 lm output/W.

EFFICIENCY
Model with reflector, apertures (52° and 33°), UGR <19, efficiencies up to 130 lm output/W.

**Special Spot distribution option (15°)*



MATERIALS



EFFICIENCY



CIRCULARITY



**ENVIRONMENTAL
PRODUCT
DECLARATIONS**

96% reduction of the CO₂ footprint in manufacturing thanks to the use of R-PC FR WHITE™ recycled polycarbonate in the reflector.

Up to **130 lm output/W.**

Conceived under 3R Criteria:

- Reduction of materials:** thanks to its miniaturisation.
- Reuse:** includes recycled materials of post-industrial origin.
- Recyclable:** designed to improve its separability and recyclability at the end of its life cycle, and ease of maintenance.

Based on UNE 15804. Which quantifies the impact on the carbon footprint considering the entire product life. Providing information for the LCA (Life Cycle Assessment) of the building.



Lamp Worktitude for light

+ TECHNICAL INFORMATION

Ind.



Comfort and wellbeing



VISUAL HEALTH

Active glare control through **COMFORT and EFFICIENCY** versions.

RG0 'risk exempt' luminaires according to the Photobiological Safety standard UNE 62471.



ENVIRONMENTAL HEALTH

Use of bromine-free flame retardant.

Polycarbonate R-PC FR WHITE™

Reflector made of recycled **polycarbonate R-PC FR WHITE™ with bromine-free flame retardant**. Flammability grade V0 according to UL94.

- Savings **70 Tn CO² Eq /year**
- **96 %** reduction of CO₂ footprint (per part)



SOLID MATE

White



Sand 2010-Y20R



METALLIC SHINE

Bronze



Champagne



Black



Dark Chocolate 8017



Terracotta 3009

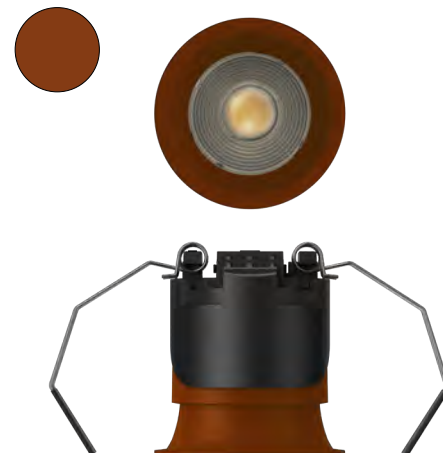

Dark Grey 7022



+ TECHNICAL INFORMATION

Ind.



KOMBIC 70
Downlight



NEW

KOMBIC 70
Downlight



KOMBIC 70 SURFACE

Technical demands and light adaptability in a compact volume

Luminaire with a demanding technical performance to meet different lighting requirements, by means of a miniaturised and compact volume.

Design by Lamp





Kombic 70 Surface

Body

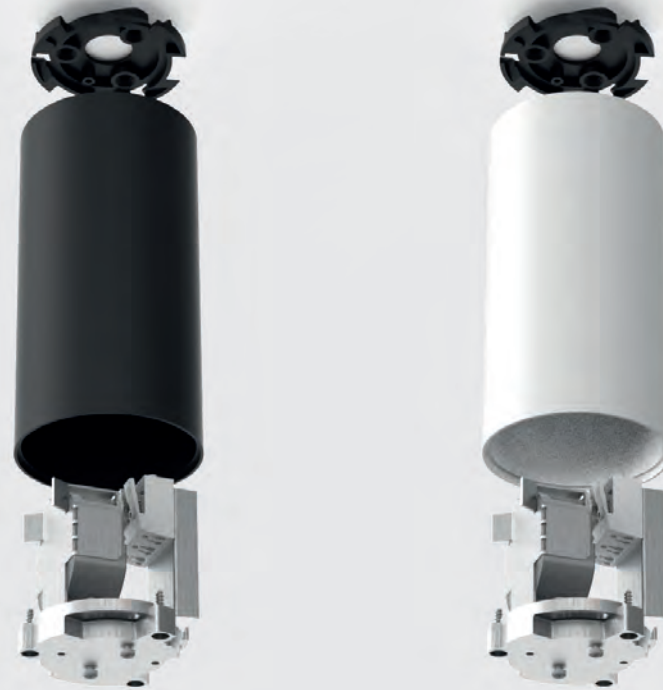

Basic
Opal 54°



Comfort
WF 52°



Efficiency
RF 33°
RW 52°

Reflector





KOMBIC 70
Short Track

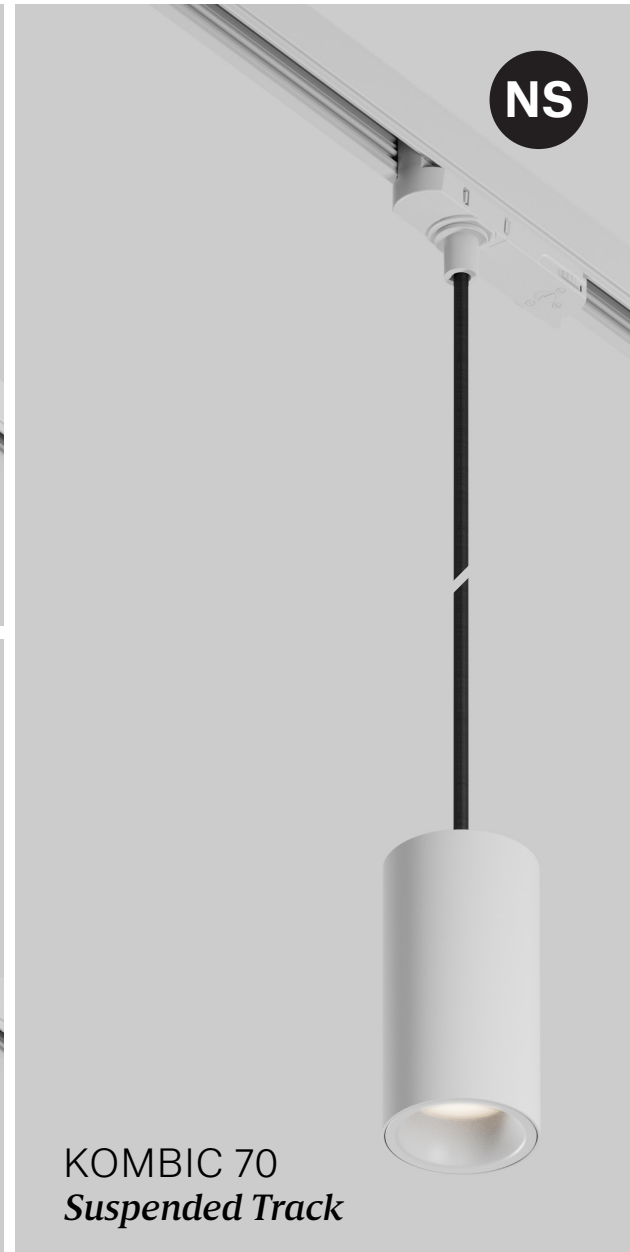

KOMBIC 70
Suspended Track



KOMBIC 70
Surface / Suspended



KOMBIC 70
Track



SOLID MATE

White



Arena 2010-Y20R



SHINE - METALLIC

Bronze



Champagne



Black



Dark Chocolate 8017



Terracota 3009



Dark Gray 7022



Kombic 70

Models

DOWNLIGHT 70



Dimensions

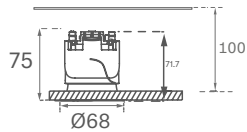

Lm LED

1500lm

IP

BASIC **IP43 IP44 IP65** COMFORT & EFFICIENCY **IP43**

IRC / CRI

80-90

Beam angle



OPAL



OPTIC



ELLIPTIC



WALLWASHER



REFLECTOR

Temp.color

2700-3000-4000K

Gear

ON-OFF/DALI

Power

8,4W

Finishes

● Black 02

○ White 02

SURFACE 70

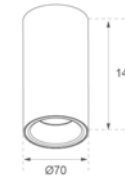

1500lm

BASIC & COMFORT **IP43** EFFICIENCY **IP23**

80-90



OPAL



OPTIC



REFLECTOR

2700-3000-4000K

ON-OFF/DALI

9,5W



NEW

KOMBIC 100
Orientable

Versatility in light direction to
suit different lighting needs.





Kombic 100 Orientable



+20°



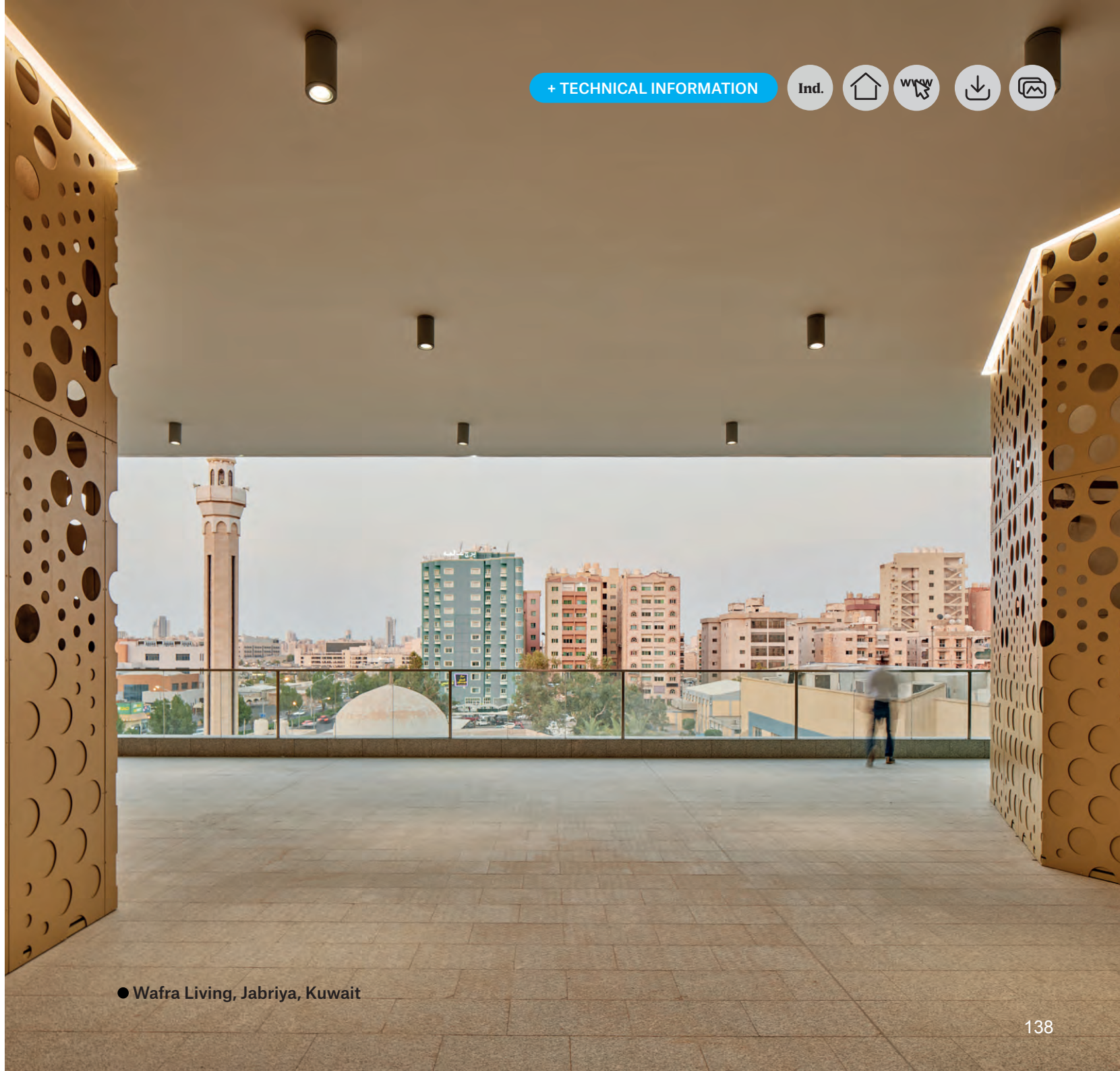

● Wafra Living, Jabriya, Kuwait



Domo 220





“Efficacy and visual comfort”

The Domo family was created for one simple reason: our desire to achieve the highest visual comfort and performance for recessed downlights. This is a high-performance technical product with a very detail-oriented design.

Design by Lamp



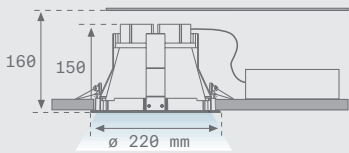
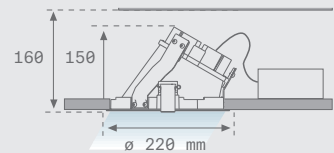

Models	DOMO 220 G2	DOMO 220 G2 ASYMMETRIC
		
Dimensions		
Lm LED	2000 lm - 4000 lm	
CRI	80	
Beam angle	 General 70°	 Asym. 70°
Color temp.	3000 / 4000 K	3000 K
Gear	ON/OFF - DALI	
Power	21 - 38 W	
Finishes	○ White 02	
Acc. Finishes	● Black 02	○ White 02 ● Grey 01



Symmetrical / asymmetrical reflector

This family of downlights consists of different lighting solutions using different reflectors, such as symmetrical and asymmetrical.



Aluminium heatsink

The heatsink in the Domo family is designed and dimensioned using injected aluminium to achieve the correct temperature dissipation and thus guarantee a LED life span of at least 50,000 hours.

+ TECHNICAL INFORMATION

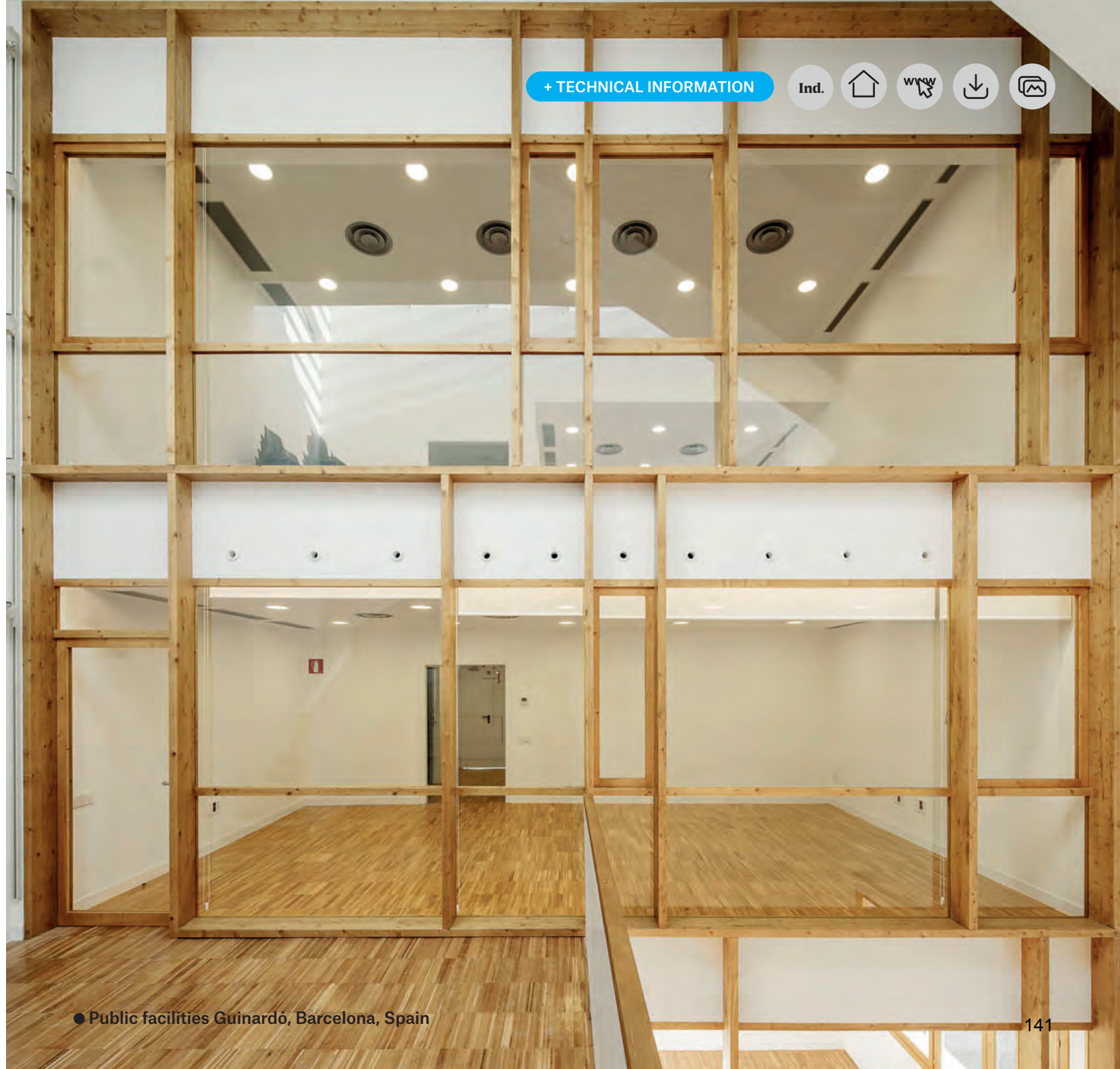

Moody

"Just play"

A tool created for play. A family in which the "Do it yourself" concept is valued above all else. Experiment with light and play with the product, changing its parts and discovering the different roles that the luminaire can play in the same space.

Design by Lamp





Environment integration

Unobtrusive with the surroundings, thanks to its small ring. It allows the integration of a trimless model but at the same time with an easy installation.



Light engine design and thermal dissipation

Design of the light engine inspired by a photographic lens. Far from being hidden, the mechanisms are shown to enhance the beauty of thermal design.

Lamp Worktitude for light











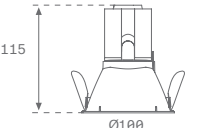

Wide range of products

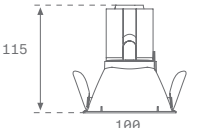
Configurable system with 360 possible combinations (without optical accessories).

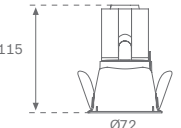

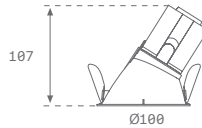
Easy to install

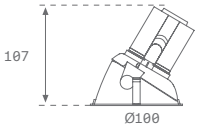
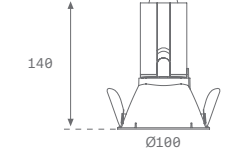
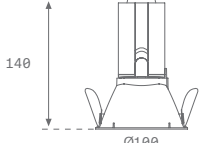
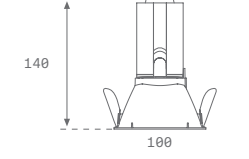
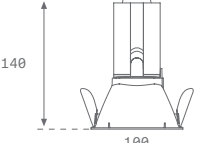
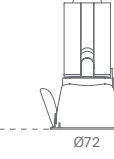
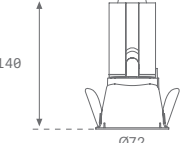
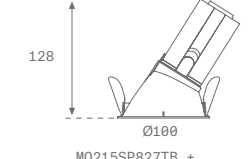
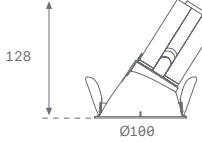
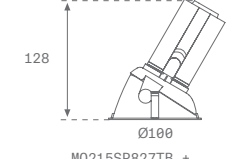
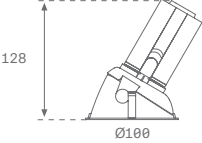
No tools needed in the installation process. Joint between Core and Reflector by pressure that could be easily disassembled. Springs used in the ceiling fixing system allow easy assembling and disassembling. The Cylinder Saw used in the recessing hole is essential.

Models	ROUND	SQUARE	MINI	ASYMMETRICAL	ADJUSTABLE
Dimensions Core 800	  M0208SP827TB + MORFRD100FXB	  M0208SP827TB + MORFSQ100FXB	  M0208SP827TB + MORFRD072FXB	  M0208SP827TB + MORFRD100ASB	  M0208SP827TB + MORFRD100ADB
Dimensions Core 1700	  M0215SP827TB + MORFRD100FXB	  M0215SP827TB + MORFSQ100FXB	  M0215SP827TB + MORFRD072FXB	  M0215SP827TB + MORFRD100ASB	  M0215SP827TB + MORFRD100ADB
Lm LED	800 lm - 1700 lm				
CRI	80 / 90				
Beam angle					
Color temp.	2700 / 3000 / 4000 K				
Gear	ON/OFF - DALI - TRIAC				
Power	5 - 12 W				
Acc. Finishes	● Black 03 ○ White 02 ● Grey 01 ● Copper 01				



Moody 800

Heat disipation



Chip On Board LED
2700 K - CRI 90
3000K - CRI 80
4000K - CRI 80

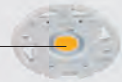

Beam reflector



Optical accessories

(max. 2 accessories applicable per luminaire)



Recessed trim reflector

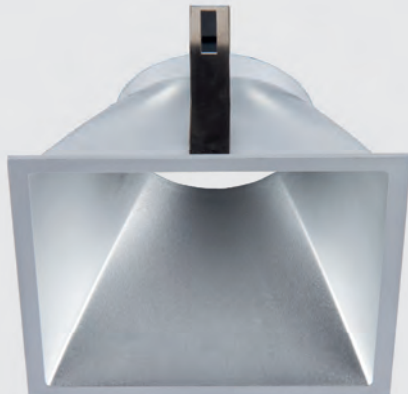

Lamp Worktitude for light

Light engine

1 | Light engine



2 | Optical accessories



Decorative accessories

3 | Recessed trim reflector



4 | Different types of finishes





● Yoga One by DIR, Rubí, Spain

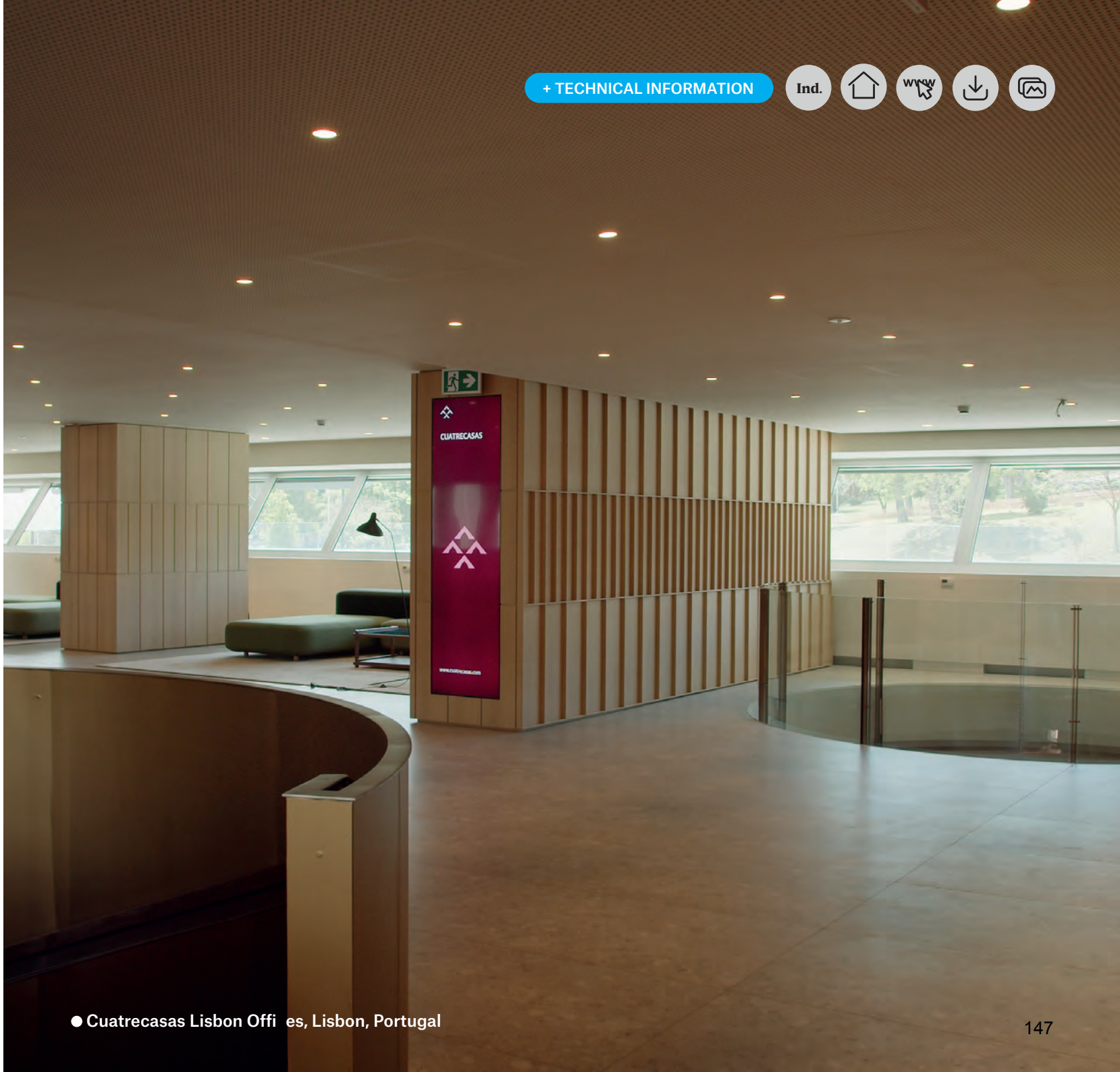



Stormbell 80

'Making the office feel like home'

In keeping with the rationalist style of its predecessor, Stormbell 80 maintains the technical requirements for high-quality lighting, lighting comfort, and glare control while adopting a friendly language for new and constantly evolving spaces. Miniaturisation and the 4 lampshade models in different shapes, sizes and materials, provide this solution with the ability to create a variety of lighting moods and a sense of proximity.

Design by Artec Studio





Technical proposal in a friendly language:

A new lighting solution for constantly evolving workspaces, featuring high-quality technical lighting based on a miniaturised light engine with a high level of lighting comfort in a wide technological variety. It is possible to choose between standard technologies in different CCT (2700 -4000K) and standard or Wellbeing technology for circadian optimisation and promotion of users' well-being.



Flexible lighting:

Multiple installation possibilities: suspended with recessed or surface-mounted rose or rail installation for Nomadic System integration.

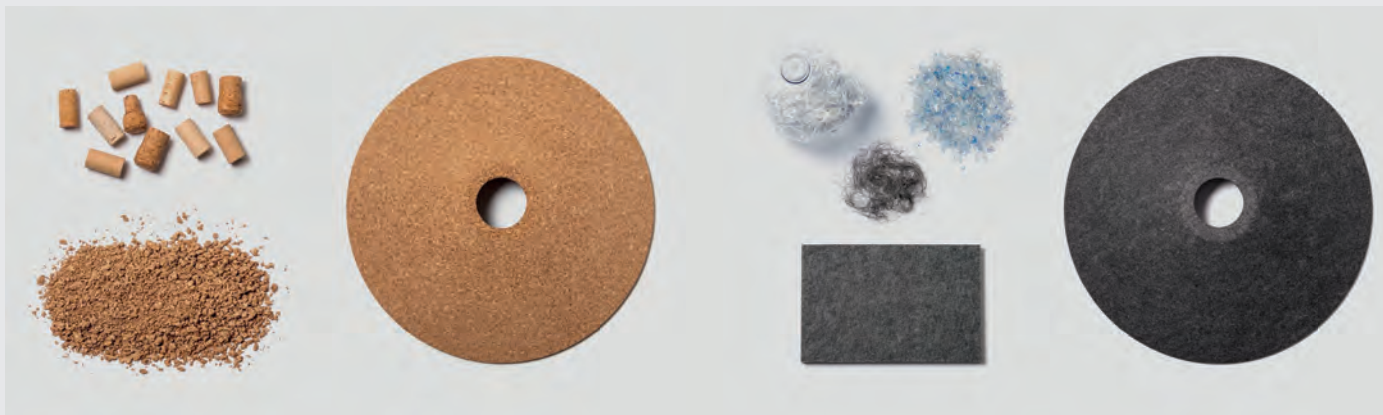

Ecodesign criteria:

Designed within a circular economy concept that facilitates the recovery and reuse of luminaires. Use of recycled materials such as recycled PET felt (from bottles) or recycled cork (from cork stoppers).



+ TECHNICAL INFORMATION

Ind.



Light Engine

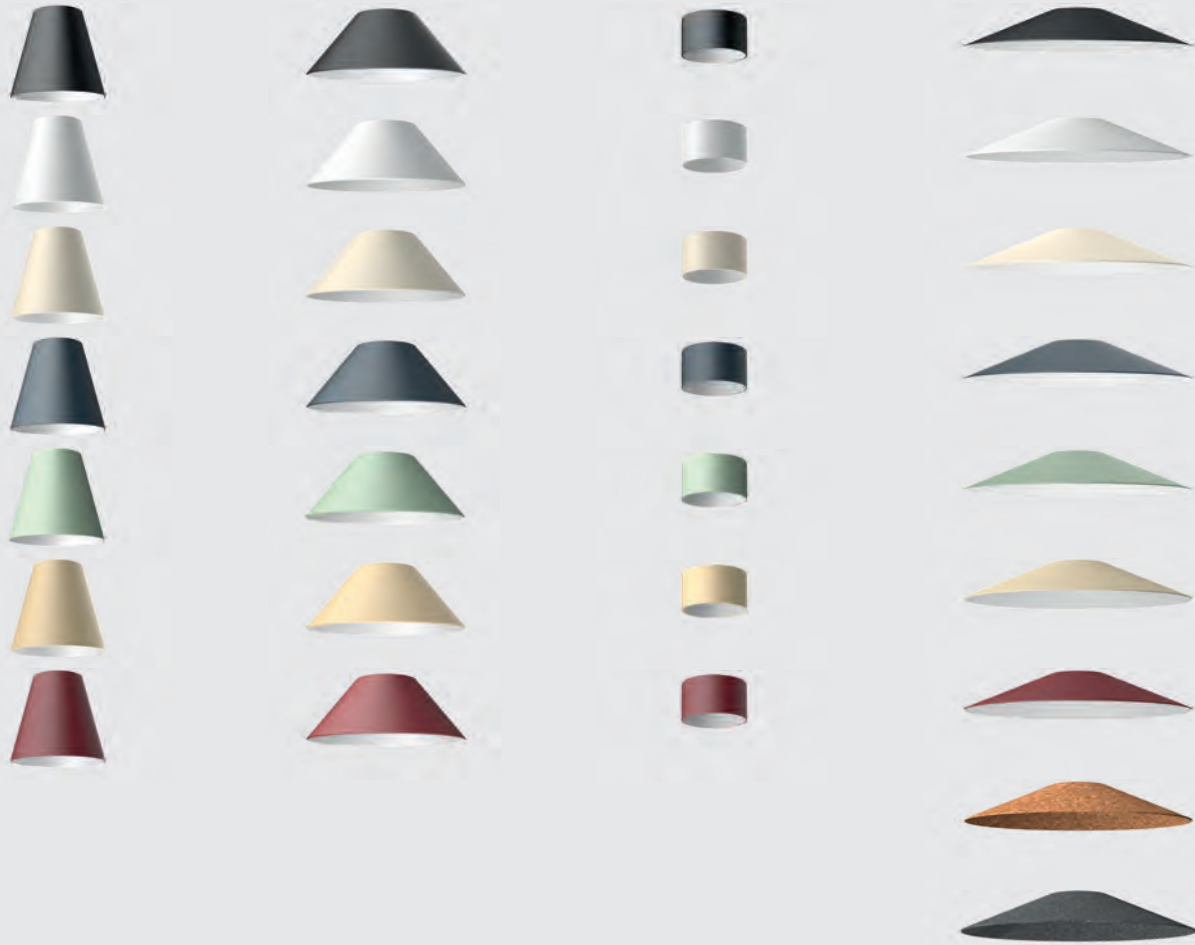

Standard Finishes

Materiality Palette

Recycled Materials

Reflector Accessories

SP 15° MFL 23°

SP 15° MFL 23° WFL 57°



Palette Materiality

Recovery Of Materiality

Real experiences

Recycling

Knowledge + Consciousness: Sustainable consumption



1505-Y10R



7024



3010-G



2010-Y20R



3013

Promotion of sustainability and social integration:

Designed within a circular economy concept that facilitates the recovery and reuse of luminaires.

PET lampshades: From bottle recycling.

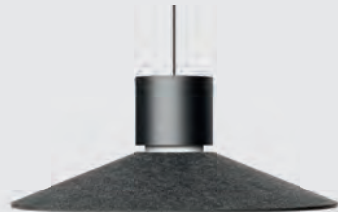

Material	Polyester Felt
Composition	20-60% rPET (recycled bottles and other containers)
Kg	0,134
Origin	4 recycled water bottles

Recycled cork lampshades: From wine and cava bottles collected by people with social integration difficulties.



Material	Recycled Cork
Composition	80-90% recycled cork stoppers
Kg	0,227
Origin	40 recycled wine stoppers



Models

SUSPENDED RECESSED



SUSPENDED SURFACE



NS SUSPENDED TRACK



Dimensions

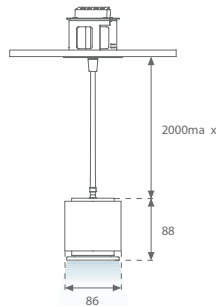

ON/OFF

DALI

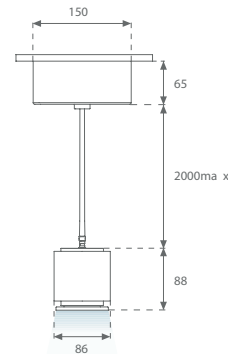
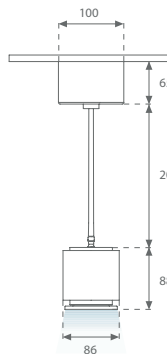

ON/OFF

DALI

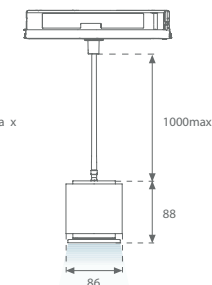
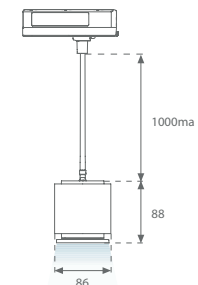

Lm LED 1500 lm

CRI 90

Beam angle



Color temp. 2700 / 3000 / 4000 K / TW / 3000 WB / 4000 WB

Gear ON/OFF - DALI

Power 14W

Finishes ○ White 04 ● Black 04

Be Social Materiality ● 1505-Y10R ● 7024 ● 3010-G ● 2010-Y20R ● 3013

Stormbell 80



+ TECHNICAL INFORMATION

Ind.





Stormbell

"A timeless bell fixture design"

A timeless design clearly inspired by rationalism. An interaction between the different types of lighting and accessories allows you to create different environments. It is perfect for use in retail and hospitality spaces.

Design by Artec Studio

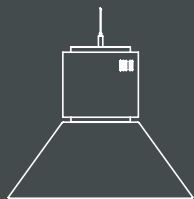



Pure geometry and timeless design

Its design is the result of pure geometris combination. Inspired by Bauhaus school timeless design (design reference).



The shape expresses function

Its shapes talk about thermal dissipation needed for the correct thermal LED management.



Deco Stormbell

Model with diffused light effect at the junction of the Core with the reflector. The reflectors / diffusers are made of special polycarbonate for LED, in three types of finishes: white, black and opal.

Lamp Worktitude for light



Configurable system

Configurable system that can fit each space with the best combination. With 144 possible combinations.

Models

STORMBELL



STORMBELL DECO



Dimensions

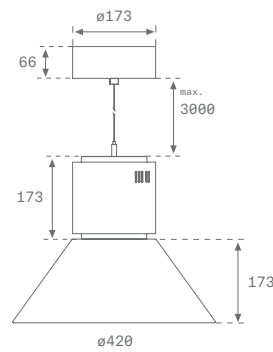
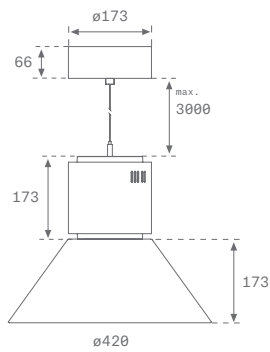

Lm LED

CRI 80

Beam angle

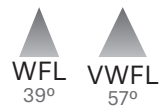

Color temp. 3000 / 4000 K

Gear ON/OFF

Power

Finishes White 04 White 04 Black 04



+ TECHNICAL INFORMATION

Ind.

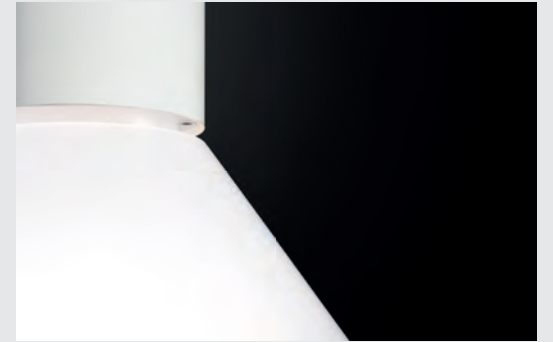



+ TECHNICAL INFORMATION



+ TECHNICAL INFORMATION

Ind. Home WPA Download Print



● Offices, Madrid, Spain

Mun

"Light to watch and light to contemplate"

Light is often thought of as a tool that serves technical and functional purposes, but light can also be used as a tool to create environments. Light with which to see and light to admire. Why not deliver these two visions in one family?

Design by Lamp





Wide family range

Mun Light has a design that allows a luminaire with a minimum height of 43mm, providing a uniform light surface in all available diameters so that they can be combined with each other: 350mm, 450mm and 600mm. Surface mounted and suspended installation is available with accessories.

Mun Dark is a versatile indirect lighting product that allows you to create different compositions in space, providing ambient lighting. Available in 120mm, 180mm and 300mm diameters for surface, wall or composite installation.

Comfort and well-being

Free of photobiological risk UNE 62471.

Flicker-free: Compliance with IEEE 1789 -2015 LED methods and according to NEMA 77-2017 (.Pst LM<1.0 and SVM <0.6).

Two luminous flux possibilities: LO (Low output) and MO (Medium Output).

Prismatic diffuser or active glare control: UGR<19 (LO and MO).

Colour temperature: 3000K 4000K.

Excellent colour rendering CRI90.

Equivalent luminance in luminous surface area in all models so that they can be combined with each other.

Ecodesign criteria

Material: recycled aluminium extrusion body.

Efficiency: up to 141lm/W.

MUN DARK

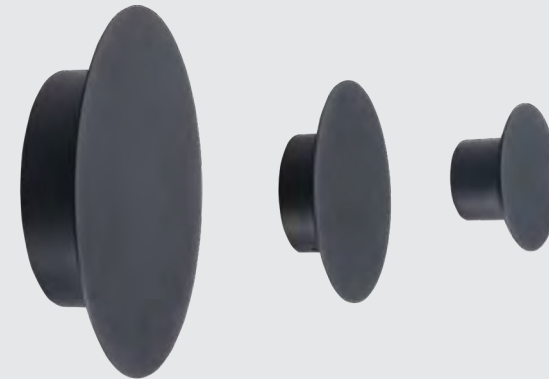



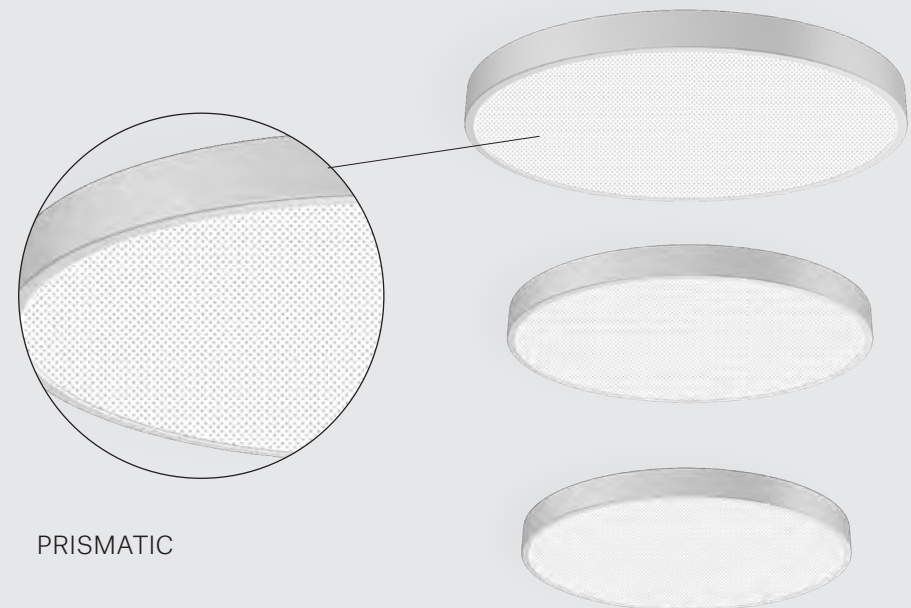

MUN LIGHT



PRISMATIC

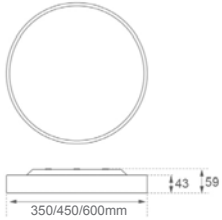
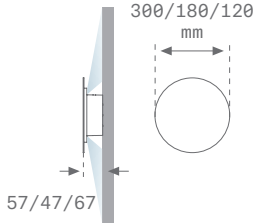

Models	MUN LIGHT	MUN DARK
		
Dimensions		
Lm LED	1000 lm - 1700 lm	100 lm - 300 lm
CRI	90	80
Beam angle	 Prismatic	 360°
Color temp.	3000 / 4000 K	
Gear	ON/OFF	
Power	8 - 60 W	1 - 3 W
Finishes	○ White 05	● Black 05

+ TECHNICAL INFORMATION

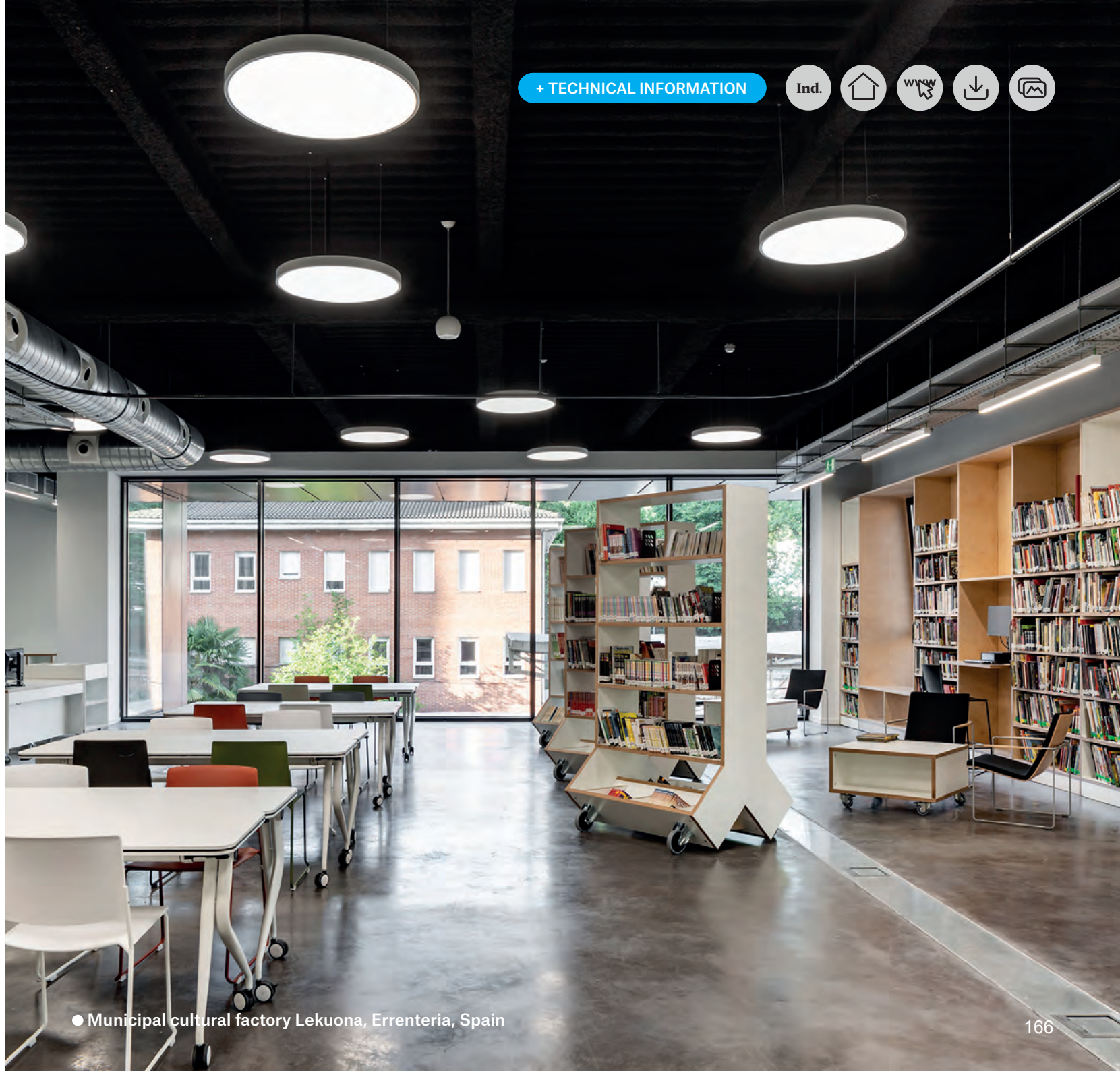

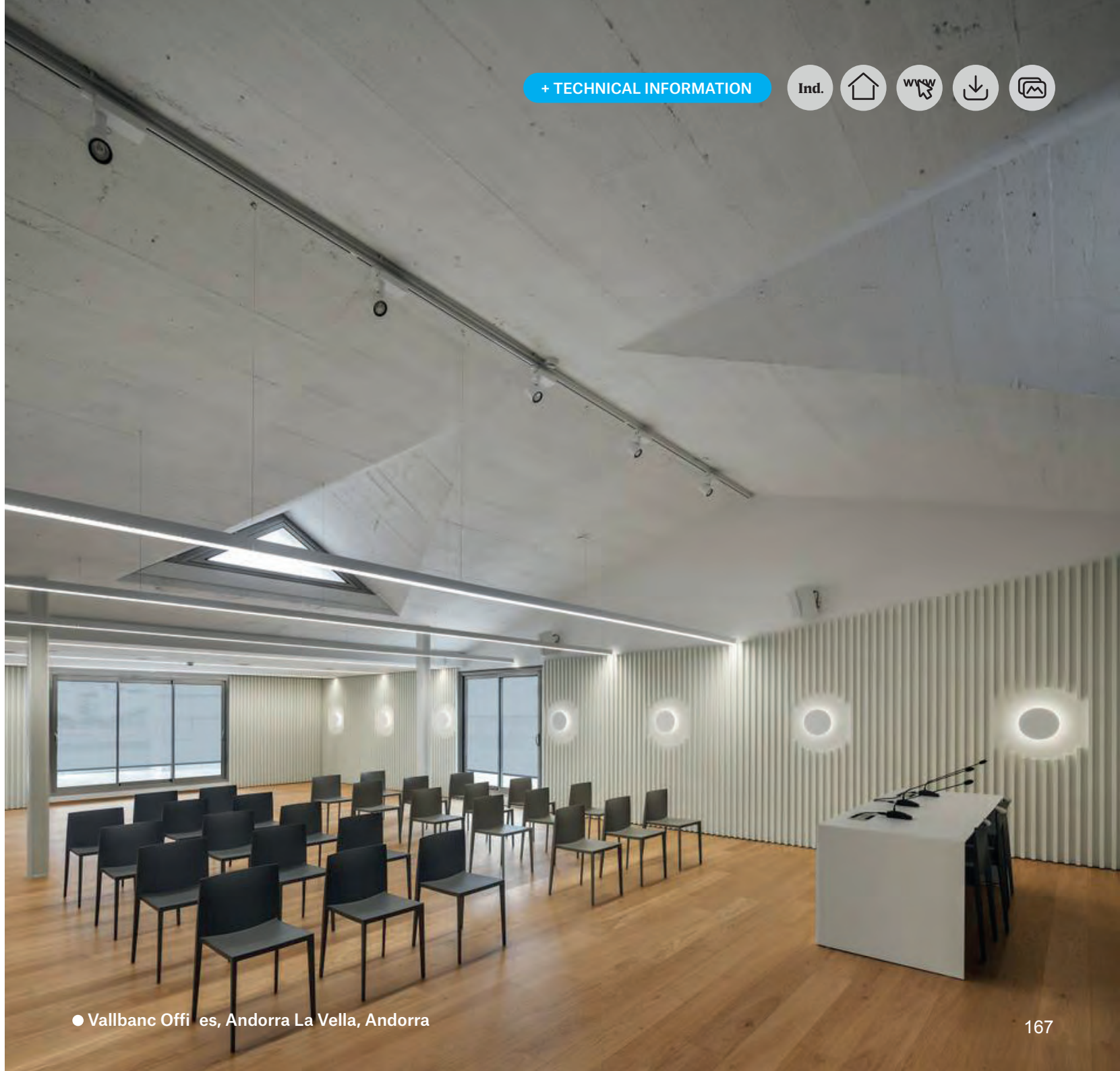



Ambient G2

"The technique of ambient light to shape the space"

Linear wall-mounted lighting solution that meets high technical requirements, maximising the volumetric expression of the space.

Design by Lamp

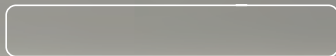

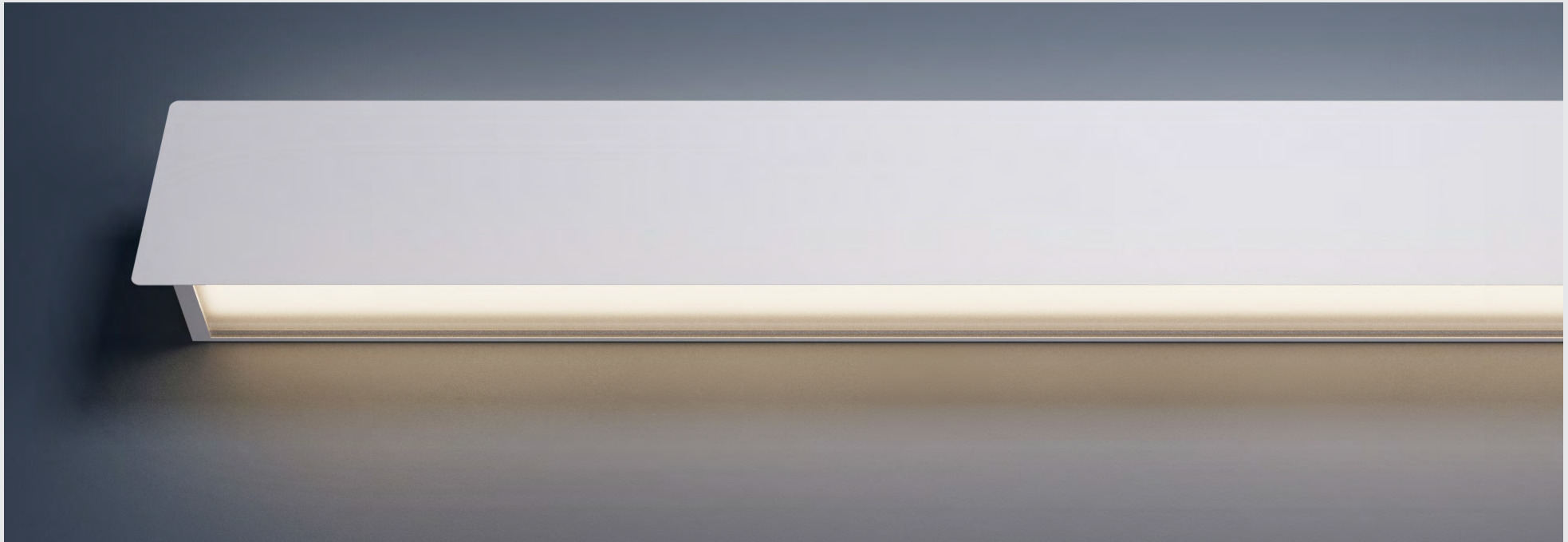

Visual comfort and well-being

Photobiological Risk Free: Group 0" according to standard recommended in UNE 62471.

Flicker-Free: Compliance with IEEE standard 1789 -2015 LED methods and according to NEMA 77-2017 (.Pst LM<1.0 and SVM <0.6).

Direct and Indirect distributions: Improving visual balance and vertical illuminance.

Multiple light distributions adapted to users' needs (Opal, Asymmetric, Grazer).

CCT 3000K and 4000K, Dynamic LED Technology with colour temperature adaptation (2700-6500K).

Ecodesign criteria

Materials: Reduction of the CO2 footprint in manufacturing thanks to the use of recycled aluminum.

Recycled aluminum: Made of extruded aluminum recycled at a rate of 80% with ASI seal.

Efficiency: up to 142 lm Out/W.

Circularity: Designed under the ecodesign criteria:

Reduce: more compact, less materials.

Reuse: incorporating materials of recycled and recyclable origin.

Repair: We extend the life of the product thanks to a modular product, extending its use phase (B6).

Recycle: Disassembled product to assess its recovery at the end of its life cycle.



Three optical versions can be combined with each other

GENERAL LIGHTING: Opal distribution for general comfortable ambient light, increasing visual comfort and contributing to the contribution of cylindrical lighting.

EFFICIENT LIGHTING: Asymmetric optic to maximise the lighting effect on horizontal planes (ceilings and floors), illuminated from the perimeter.

ACCENT LIGHTING: Grazer optic to emphasise vertical surfaces and highlight textures.

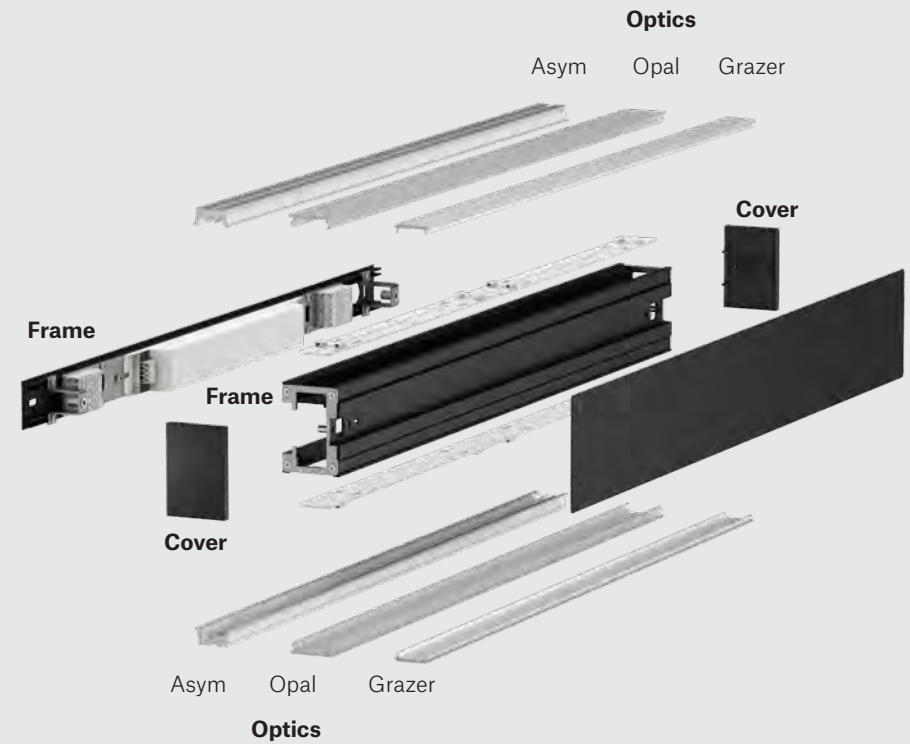
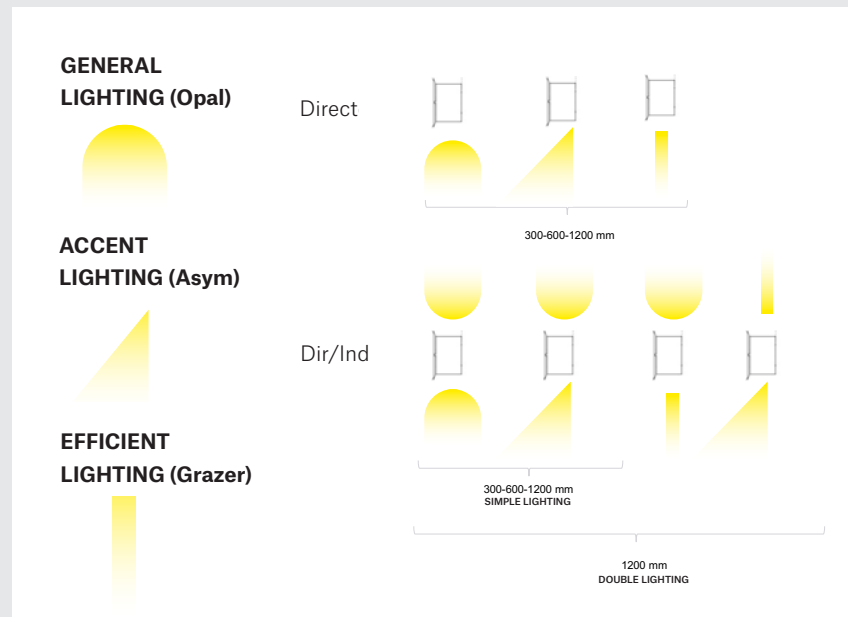



Application and functionality

Individual and Continuous Line Installation: Pre-installed wall-mounted frame to absorb surface irregularities and facilitate the installation of continuous lines.

Application: Individual and double ignition, for precise control depending on the lighting application.

Luminaire fini hes:

- WHITE / BLACK.
- FOUNDATION and RETROPIA palettes.

Front accessory fini hes:

- WHITE / BLACK.
- ANODISED: gold, bronze, champagne, blue and black*.
- RAW: the most honest materiality*.

**Finishes only available for front accesory. Luminaire black or white.*

RETROPIA

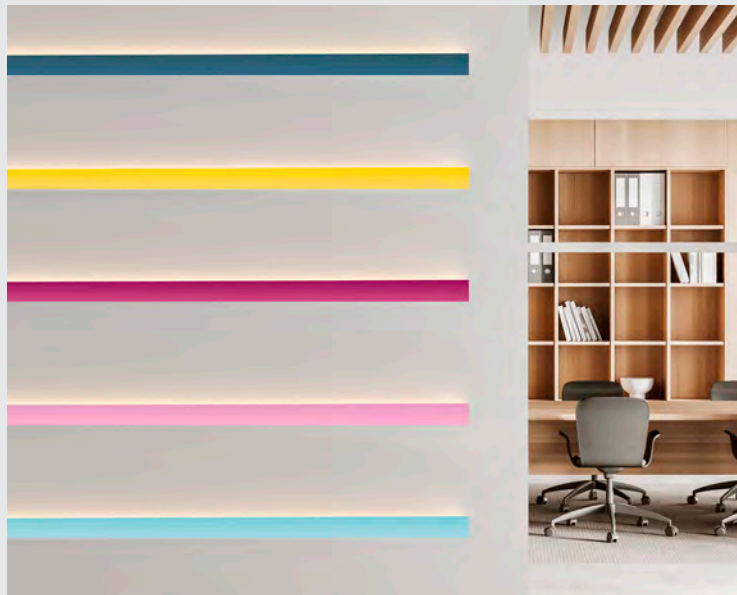

FOUNDATION



FRONT ACCESSORY FINISHES

BLACK



WHITE



Anodised
BLACK



Anodised
BRONZE



Anodised
BLUE



Anodised
CHAMPAGNE

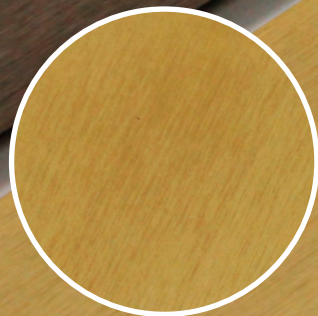

Anodised
GOLD



RAW



Models	INDIVIDUAL Direct Direct/Indirect Double Switch	CONTINUA Direct Direct/Indirect Double Switch
---------------	---	---



Dimensions	300-600-1200mm	600-1200mm
-------------------	----------------	------------

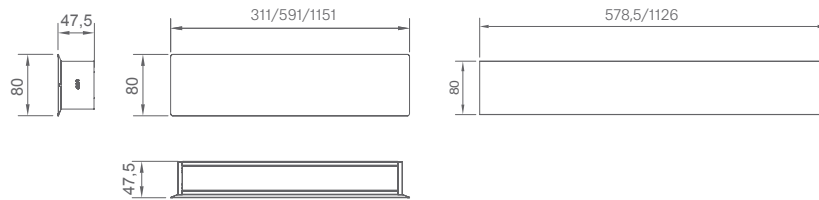

LM LED	2500lm/m
---------------	----------

CRI	80
------------	----

Beam angle	Opal	Asimétrico	Grazer

Color Temp.	3000K	4000K	TW
--------------------	-------	-------	----

Gear	ON/OFF	DALI
-------------	--------	------

Power	Direct 6W 10W 19W	Direct / Indirect 10W 19W 35W	Double Switch 35W
--------------	----------------------------	--	----------------------

Finishes	Black 02	White 02	Retropia	Foundation	Anodized (acc.)
-----------------	----------	----------	----------	------------	-----------------



*Finishes only for frontal accessory.

FIL SYSTEM

Design by Lamp





Visual comfort

Integrated lighting solutions meet high requirements:

Active glare control: **opal confort.**



RGO 'risk exempt' luminaires according to the Photobiological Safety standard UNE 62471.

High visual comfort models with **large shielding angle, black reflectors and ultra confort optics.**

Flicker free.

Modular and versatile concept

Different types of luminaires, light distributions and colour temperatures to **integrate the different applications required by the project**, whether general or accent lighting, in a single system.



Sustainability

Designed within a circular economy concept that facilitates the recovery and reuse of luminaires.
Made of recycled extruded aluminium.



Configurator Fil 45

It is a **configurable and combinable system that adapts** to the needs of any project.

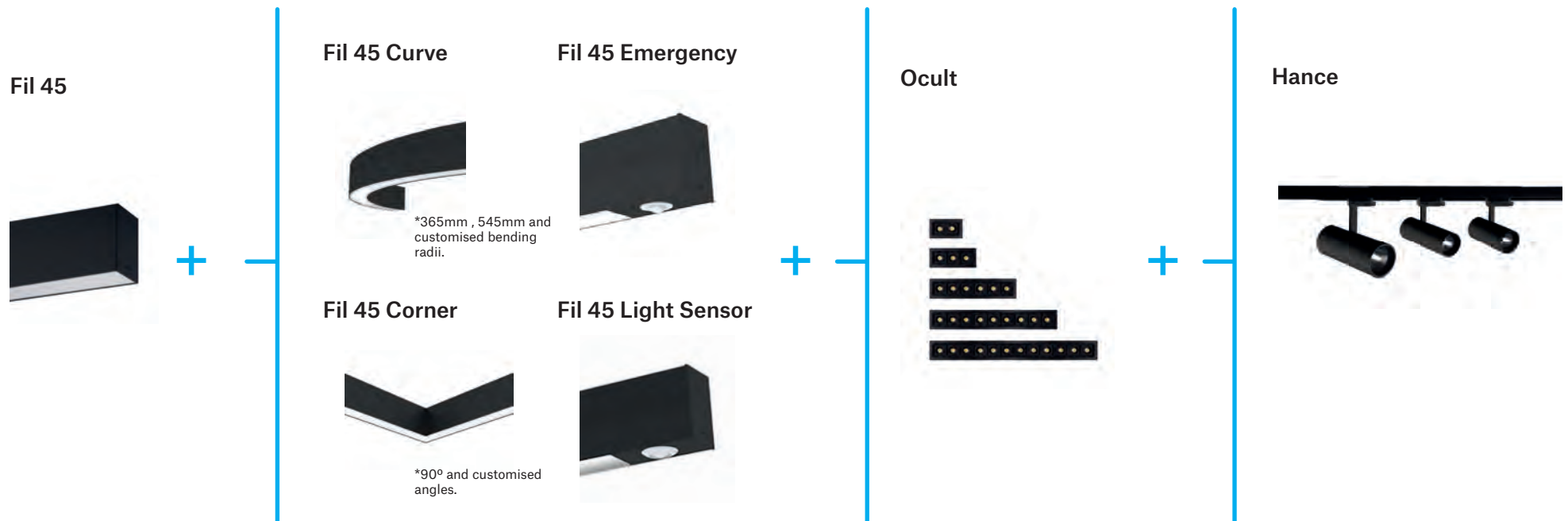

Fil 45 Emergency

Emergency kits Fil 45 offer a fully integrated solution in the luminaires to provide safety, regulatory compliance, ease of installation and maintenance.

It is a reliable solution that guarantees the safety of users.



Fil 45 Emergency

INTEGRATED EMERGENCY SYSTEM

All integrated in a **single lighting solution**. It guarantees the availability of emergency lighting in case of power outages, which **increases the safety of users and allows a safe evacuation in emergency situations**. **Integrated status indicator** for operation confirmation. Standard technology.

VERSATILY AND FLEXIBILITY

Availability of 3h autonomy that ensures uninterrupted operation during emergency situations, depending on needs.

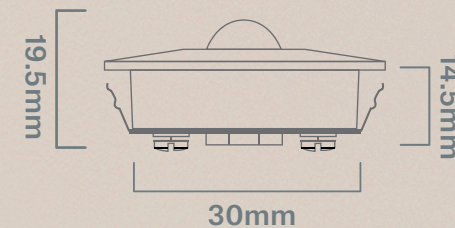
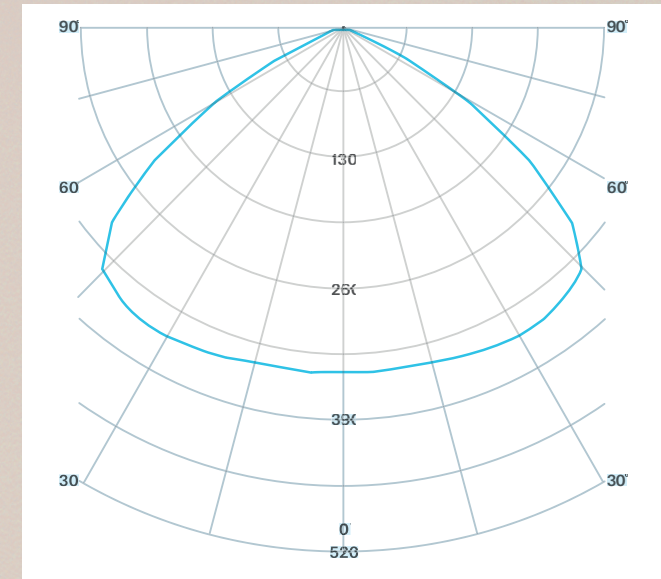

Fil 45 Light Sensor

The luminosity and presence sensor complement for the Lamp Fil 45 luminaire offers advantages in terms of **energy saving, visual comfort, convenience and regulatory compliance.**



Fil 45 Light Sensor



ENERGY SAVING

The luminosity and presence sensor complement allows the Fil 45 luminaire to automatically **adjust its lighting level based on the amount of natural light available in the environment**. This ensures efficient use of energy by avoiding unnecessary switching on of lights when there is sufficient natural light.



VISUAL COMFORT

By adapting to ambient light conditions, the Fil 45 luminaire **provides a comfortable, glare-free environment**, which contributes to the visual well-being of users.



EFFICIENT INTERACTION

Allows automatic switching on of the luminaire when presence is detected in the room. As well as automatic shutdown when there is no presence, it also allows the **custom configuration** of a gradual shutdown, allowing the flow to be reduced for a few minutes, before proceeding to complete shutdown, according to specification.



Fil 45 Curve

Fil 45 Curve complements the Fil 45 family by offering two radii of curvature for **greater versatility in the space lighting.**

Fil 45 Curve



RADIUS OF CURVATURE

365mm
545mm



INSTALLATION FLEXIBILITY

Available in surface profile and with suspension option, facilitating its integration into different configurations and lighting designs.

COMPATIBILITY AND VERSATILITY

Combinable with other products from the Fil 45 such as straight lines, 90° corners and even personalized angles. This allows for creative optimization in lighting projects and greater **flexibility in the design.**

PERSONALIZATION

Possibility of **manufacturing custom radii of curvature** to meet specific lighting requirements. Our team is trained to **design custom lighting shapes, sizes and technologies.**

Min. custom radius: 365mm

Max. custom radius: on request

+ TECHNICAL INFORMATION

Ind.





Models

OPAL

OPAL COMFORT



Dimensions

SURFACE

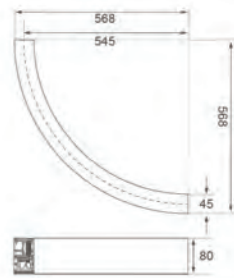
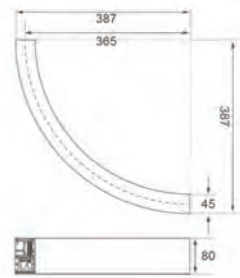

Lm LED

Curvature radii

365 mm

545 mm

CRI

80 / 90

Beam angle



Opal



Opal
Comfort

Color temp.

3000 / 4000 K

Gear

ON/OFF - DALI

Acc. Finishes

● Black 02

○ White 02

● Grey 01



Configurator Fil 45

Fil 45



Fil 45 Curve



*365mm , 545mm and customised bending radii.

Fil 45 Corner



*90° and customised angles.

Fil + Fil Curve / Corner



Rivana Business Park Torre Norte (Oficinas Tigo), Colombia



RCI Sofasa, Colombia

Configurator Fil 45

Fil 45



Ocult



Fil + Ocult



Business Center Central Point, Colombia

Configurator Fil 45

Fil 45



Hance



Fil + Hance



Pre-school Sagrado Corazón Montemayor, Colombia



FIL

“Lighting versatility and high visual comfort”

Fil is a versatile family. This design offers multiple installation and finishes, as well as a wide variety of luminous flux and optical features.

Design by Lamp

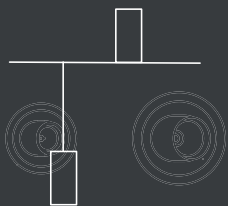

+ TECHNICAL INFORMATION

Ind.



Fil 35

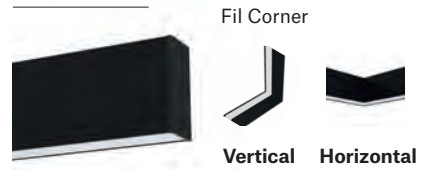

Fil 45



Fil 50

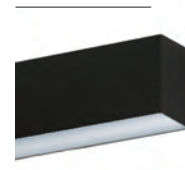

Fil 70



Fil 120



Installation

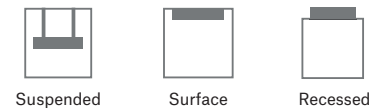
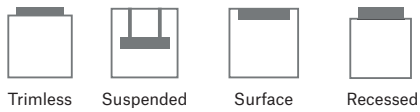

Optics



Distribution



Available dimensions

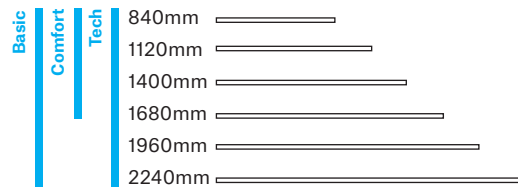

1123mm

1683mm

1162mm

1740mm

Ex. Finishes



Fil | Indoor

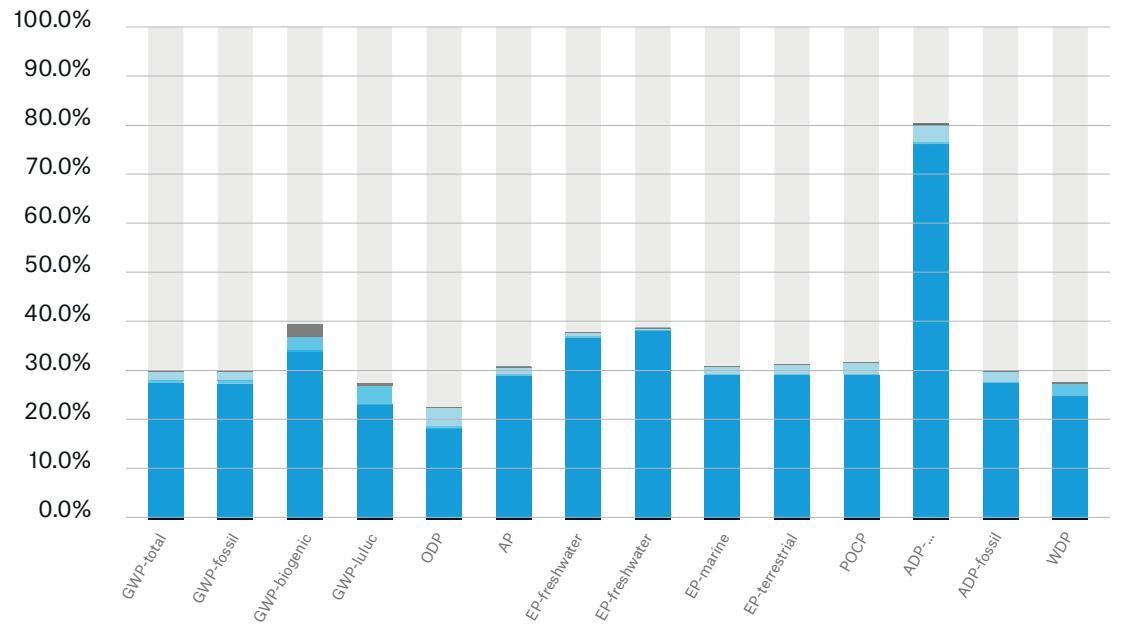
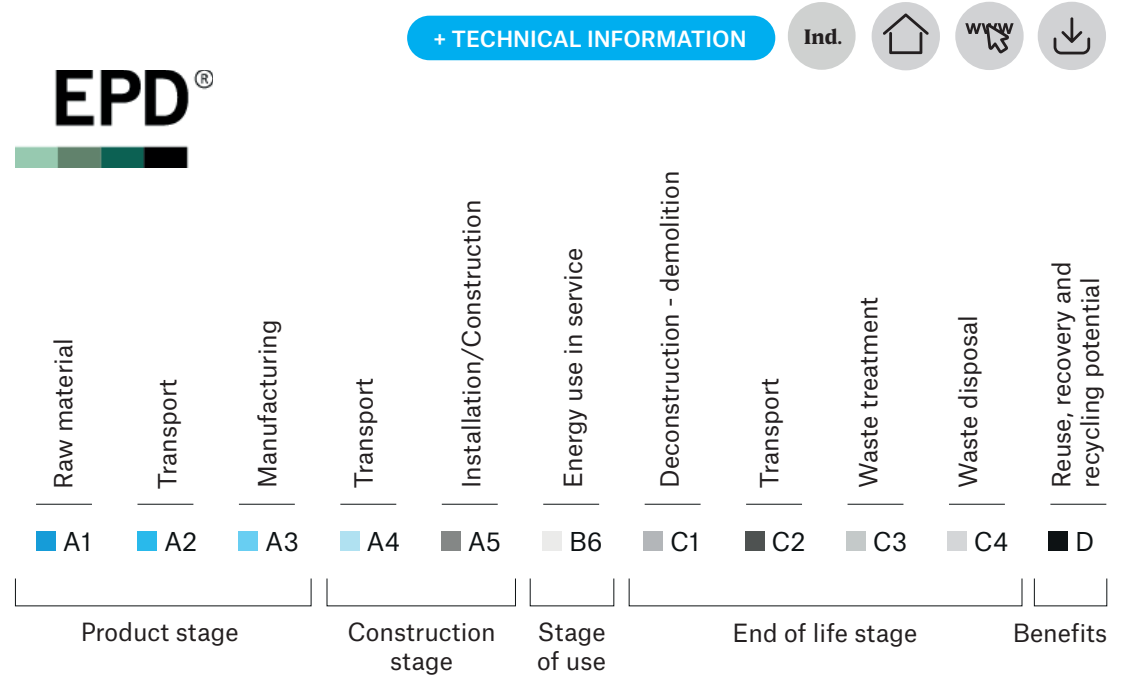

TECH ULTRACOMFORT

Design by Lamp

FIL 35 & FIL 45





Lamp Worktitude for light

Fil 35



Comfort and wellbeing



**VISUAL
HEALTH**

UGR
12



MATERIALS



EFFICIENCY



CIRCULARITY



**ENVIRONMENTAL
PRODUCT
DECLARATIONS**

+ TECHNICAL INFORMATION

Ind.



Active glare control through **TECH ULTRACOMFORT** optics.

Flicker free.

40% reduction of the CO₂ footprint in manufacturing thanks to the use recycled aluminium.

Up to **99 lm output/W**.

Conceived under 3R Criteria:

Reduction of materials: thanks to its miniaturisation.

Reuse: includes recycled materials of post-industrial origin.

Recyclable: designed to improve its separability and recyclability at the end of its life cycle, and ease of maintenance.

Based on UNE 15804.

Which quantifies the impact on the carbon footprint considering the entire product life. Providing information for the LCA (Life Cycle Assessment) of the building.



Fil 45



Comfort and wellbeing



**VISUAL
HEALTH**

UGR
<16



EFFICIENCY



CIRCULARITY



**ENVIRONMENTAL
PRODUCT
DECLARATIONS**

+ TECHNICAL INFORMATION

Ind.



Active glare control through **TECH ULTRACOMFORT** optics.

Flicker free.

Dark Light effect: is less than 200cd/Im² above a viewing angle of 60°. It creates a discreet illumination that respects the user's comfort and does not cause glare.

Up to **105 lm output/W**.

Conceived under 3R Criteria:

Reduction of materials: thanks to its miniaturisation.

Reuse: includes recycled materials of post-industrial origin.

Recyclable: designed to improve its separability and recyclability at the end of its life cycle, and ease of maintenance.

Based on UNE 15804.

Which quantifies the impact on the carbon footprint considering the entire product life. Providing information for the LCA (Life Cycle Assessment) of the building.



Fil 35

*“Reinventing a classic concept:
Lighting expression”*

The miniaturisation of this product family retains linearity while performing as a lighting solution to highly demanding spaces in terms of formality requirements, blending in fully with its surroundings. Fil 35 is the structure that fits the maximum technology within the minimum volume.

Design by Lamp

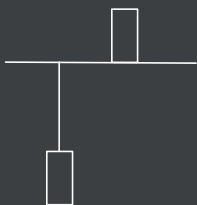



Miniaturisation

The miniaturisation of this family gives a lighting solution for highly demanding spaces in terms of formality requirements, by respecting and enabling a perfect integration in its environment. Fil 35 is the structure that conforms to the maximum technology within the minimum volume.

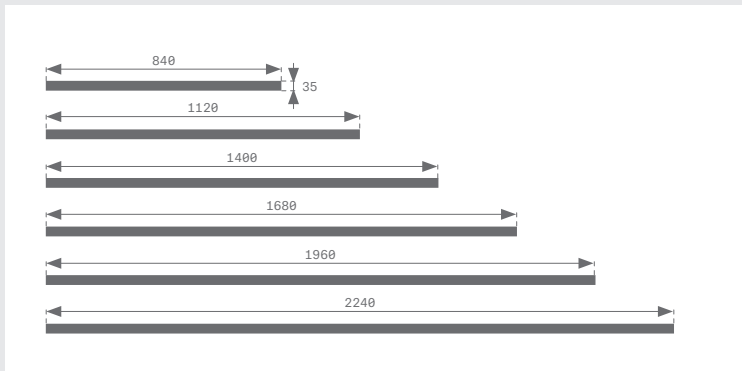

Great variety of lengths

This is a linear luminaires family with a wide range of lengths, available in six standardised dimensions and with the possibility of customising special lengths. The miniaturisation of the profile dimensions enables a high integration of the product in the space.

Lamp Worktitude for light



Horizontal and vertical elbows for 3D configurations



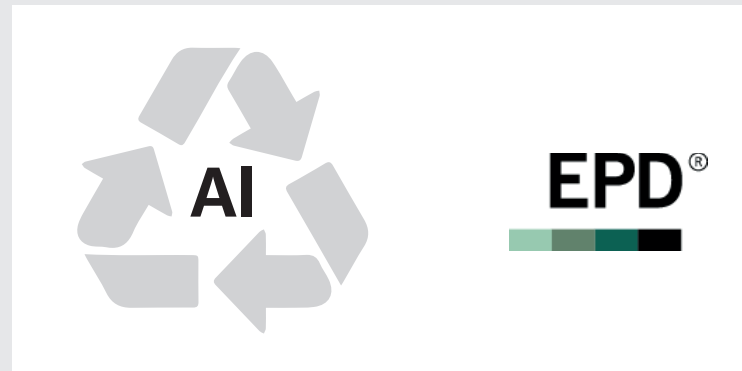

It can be installed surface, recessed, and recessed without trim, in black, white, or matte grey finishes. 90° corners are also designed to be installed in both horizontal and vertical directions, enabling 3D configurations to be made.

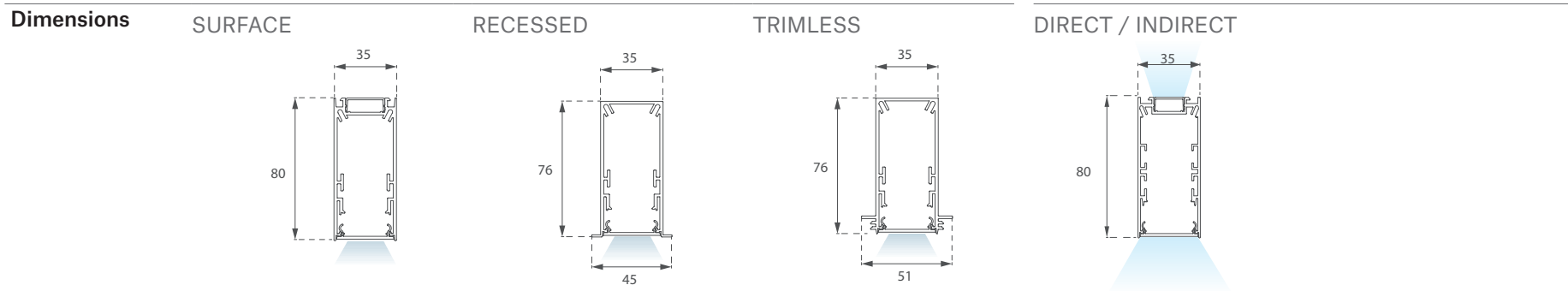

#Worktitude For Life

Product made of recycled aluminium extrusion at a rate of 80-85%, reducing the carbon footprint of products and processes, as well as the environmental impact across the entire value chain.



Lm LED	1200 lm	1470 lm	1600 lm	2000 lm	2400 lm	2650 lm	2800 lm	3200 lm	
Lenghts	840 mm	1120 mm	1400 mm	1680 mm	1960 mm	2240mm			
CRI	80 / 90								
Beam angle	 Opal	 Opal Comfort		 Tech	 Dir / Ind				
Color temp.	3000 / 4000 K								
Gear	ON/OFF - DALI								
Power	8 W	11 W	12 W	14 W	16 W	18 W	19 W	22 W	32 W
Acc. Finishes	● Black 02		○ White 02		● Grey 01				



Fil 45

*"A classic's functional evolution:
The calling to give answers"*

Retaining the family's timelessness, Fil expands reducing its dimensions and increasing its possibilities. Fil 45's calling is to provide quality general lighting, capable of adapting to any space. While responding to the high lighting requirements that a project may require.

Design by Lamp

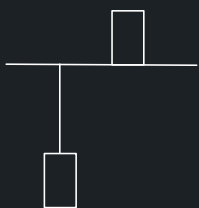



Variety of light distributions

Possibility to choose between Opal, Opal Comfort and Tech diffuser Ultracomfort according to the lighting requirements of each application. **The Tech Ultracomfort** option also offers two light distributions, using a black reflector of polycarbonate with a symmetrical (TE) or asymmetrical (TA) optic.



Visual comfort.

Two solutions with optimized light distributions for provide visual comfort:

- **Opal Comfort**, maintaining a uniform opaline aesthetic, incorporates a technical sheet, providing greater control luminous (UGR<16).
- **Tech UltraComfort**, combined optics to offer an active glare control (UGR<15).
Dark light effect: satisfies the requirements of the limit of darkness that classifies it as Dark Light: it is less than 200cd/lm² above a viewing angle of 60°.
High real luminous efficiency (105lm/W).



Integrated functional and ambient lighting

Direct and indirect lighting integrated in the same luminaire: double lighting effect for suspension installation. Design designed for spaces in which you want to highlight the ceilings or achieve less visual fatigue, such as in work spaces and offices, **avoiding high contrasts and glare.**



#WorktitudeForLife, environmental impact assessment.

Manufactured from recycled extrusion aluminum at a rate of 80-85%, thus reducing the carbon footprint and environmental impact. The Fil family has been designed with ACV in mind (Life Cycle Analysis), and has EPD.

Download:

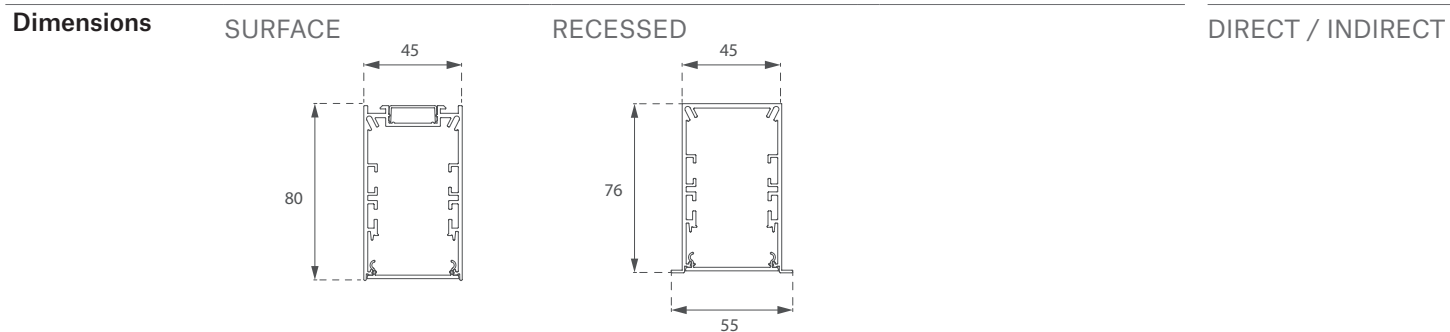

Lm LED	1450 lm	2600 lm	3250 lm	3900 lm	4550 lm	3200 lm
	4650 lm	6200 lm	7750 lm	9300 lm	10850 lm	12400 lm
Lengths	840 mm	1120 mm	1400 mm	1680 mm	1960 mm	2240mm
CRI	80 / 90					
Beam angle	Opal	Opal Comfort	Tech	Dir / Ind		
Color temp.	3000 / 4000 K / TW / WB					
Gear	ON/OFF - DALI					
Power	12 W	16 W	19 W	23 W	27 W	31 W
	27 W	36 W	45 W	54 W	63 W	72 W
Acc. Finishes	● Black 02		○ White 02		● Grey 01	



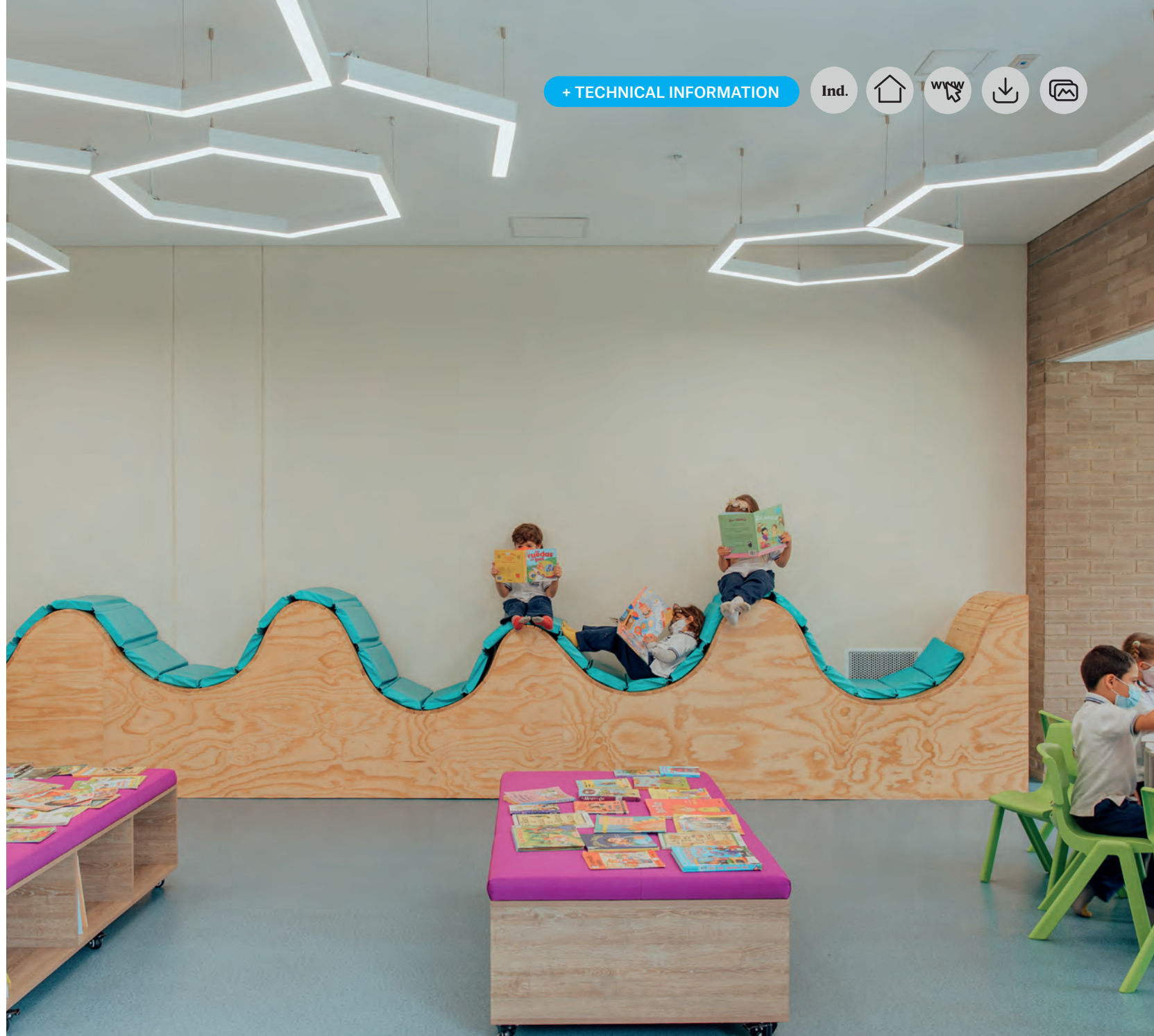



Fil 50

"Integration in every interior space"

Fil 50 is a family of structures characterised by its neutral, minimalist, and timeless designs. These qualities, and its wide range of options, will allow you to use these products in a variety of different ways in any kind of interior space.

Design by Lamp

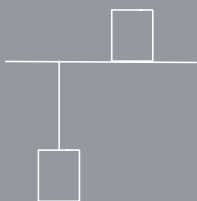

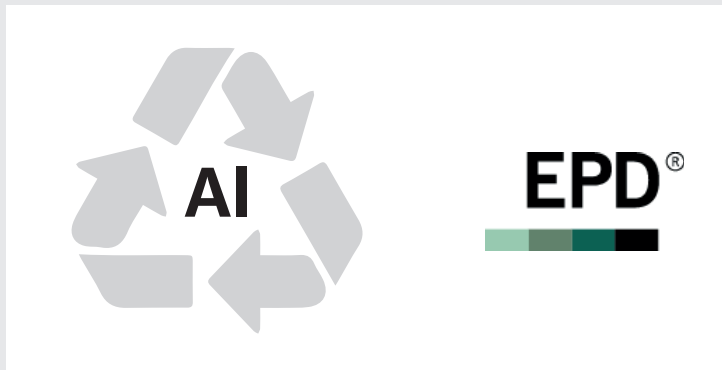
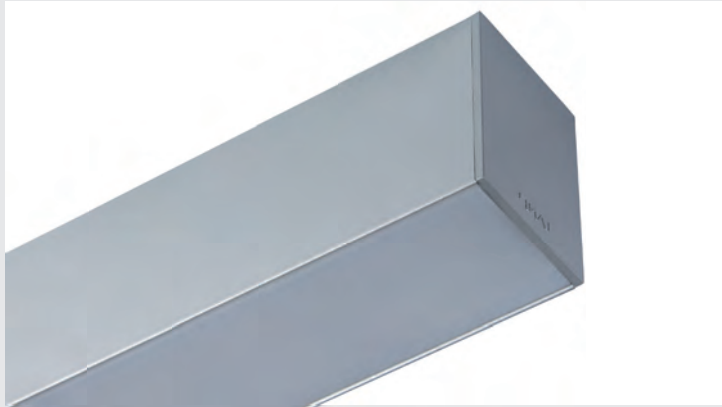



#Worktitude For Life

Product made of recycled aluminium extrusion at a rate of 80-85%, reducing the carbon footprint of products and processes, as well as the environmental impact across the entire value chain.

Models	OPAL	PRISMATIC	SLIM
---------------	------	-----------	------

Dimensions

Lengths	1123 mm	1683 mm
Lm LED	3000 lm 6000 lm	4600 lm 9200 lm
CRI	80	
Beam angle	 Opal	 Prismatic
Color temp.	3000 / 4000 K	
Gear	ON/OFF - DALI	
Power	21 W 40 W	31 W 59 W
Finishes	<input type="radio"/> White 02	<input checked="" type="radio"/> Grey 01

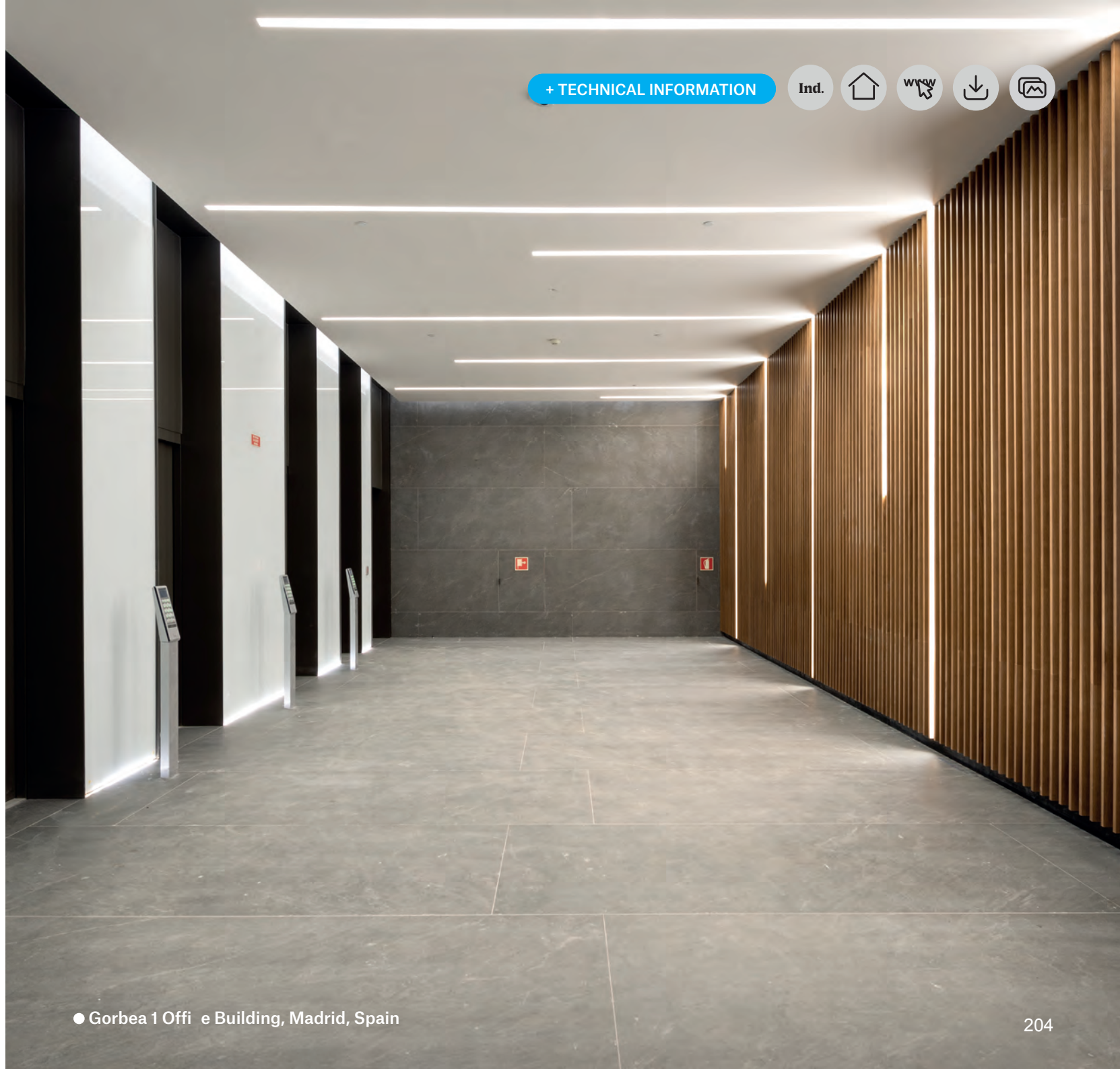





Fil 70

“Versatility expressed as structure”

When a luminaire can adapt to any space, it has one of the most valuable characteristics a product can have: versatility. With a minimalist design, Fil 70 covers a broad range of applications with indirect and direct lighting options, low-glare models, asymmetrical distribution, and distinct installation choices.

Design by Lamp

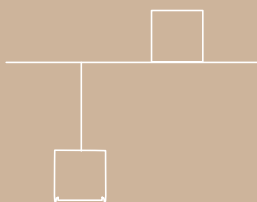



Lighting control

The Fil 70 range has a wide range of optical solutions, such as the tech and asymmetric light distributions.



Functional and environmental lighting

Direct and indirect lighting integrated into the same luminaire, achieving a double lighting effect for the installation of suspended Fil. Designed for spaces aiming to highlight ceilings or reduce visual fatigue, such as work spaces and offices, avoiding high contrast and glare.

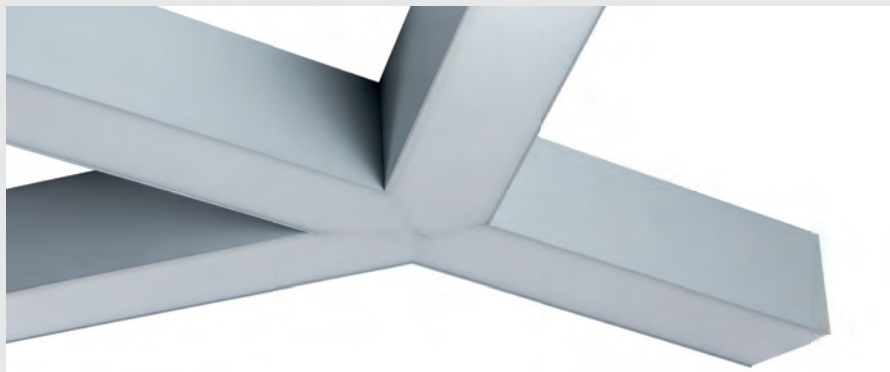

Modular geometric configurability

Linear system to set up the continuous lines through joints, and also special geometries through 90° L-shaped corners.

Photobiological Risk



Our Fil family is classified in the 'Group 0' of photobiological risk, and is therefore completely risk-free. The application of this type of product is extremely important in certain applications, in which users are exposed to artificial lighting for long periods, or spaces where the main users are highly sensitive to light.

#Workititude For Life



Product made of recycled aluminium extrusion at a rate of 80-85%, reducing the carbon footprint of products and processes, as well as the environmental impact across the entire value chain.



Models	OPAL		PRISMATIC		DIRECT / INDIRECT		TECH / TECH ASYMMETRIC			
Dimensions	SURFACE		RECESSED		SURFACE		SURFACE		RECESSED	
Lengths	1162 mm		1743 mm				1000 mm		2000 mm	
Lm LED	2600 lm 4400 lm		3900 lm 6600 lm				1600 lm 3200 lm		3200 lm 6400 lm	
CRI	80									
Beam angle										
	Opal		Prismatic		Opal		Tech		Tech Asym.	
Color temp.	3000 / 4000 K									
Gear	ON/OFF - DALI									
Power	17 W 28 W		25 W 41 W				12 W 21 W		25 W 42 W	
Finishes	○ White 02		● Grey 01							

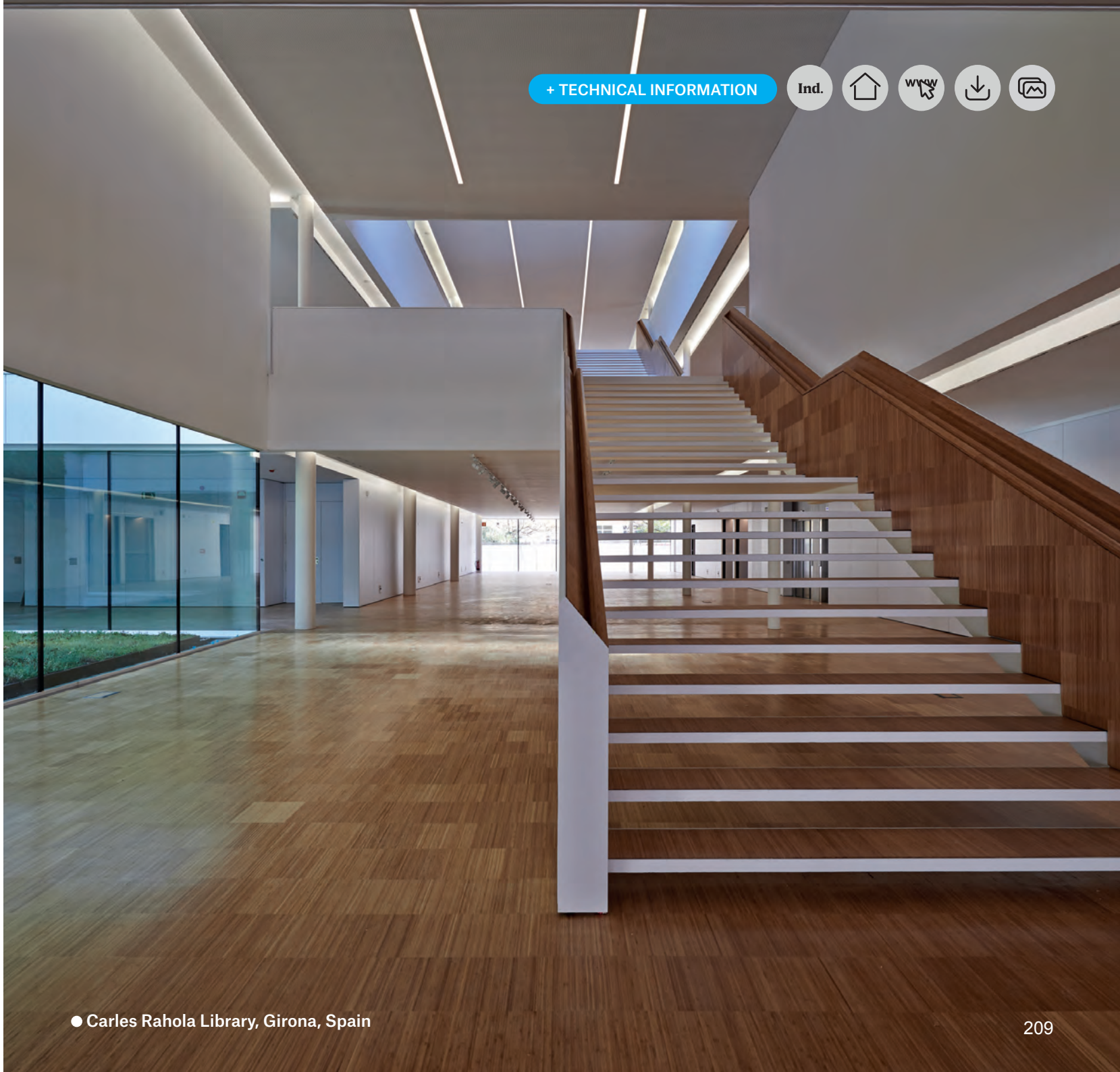

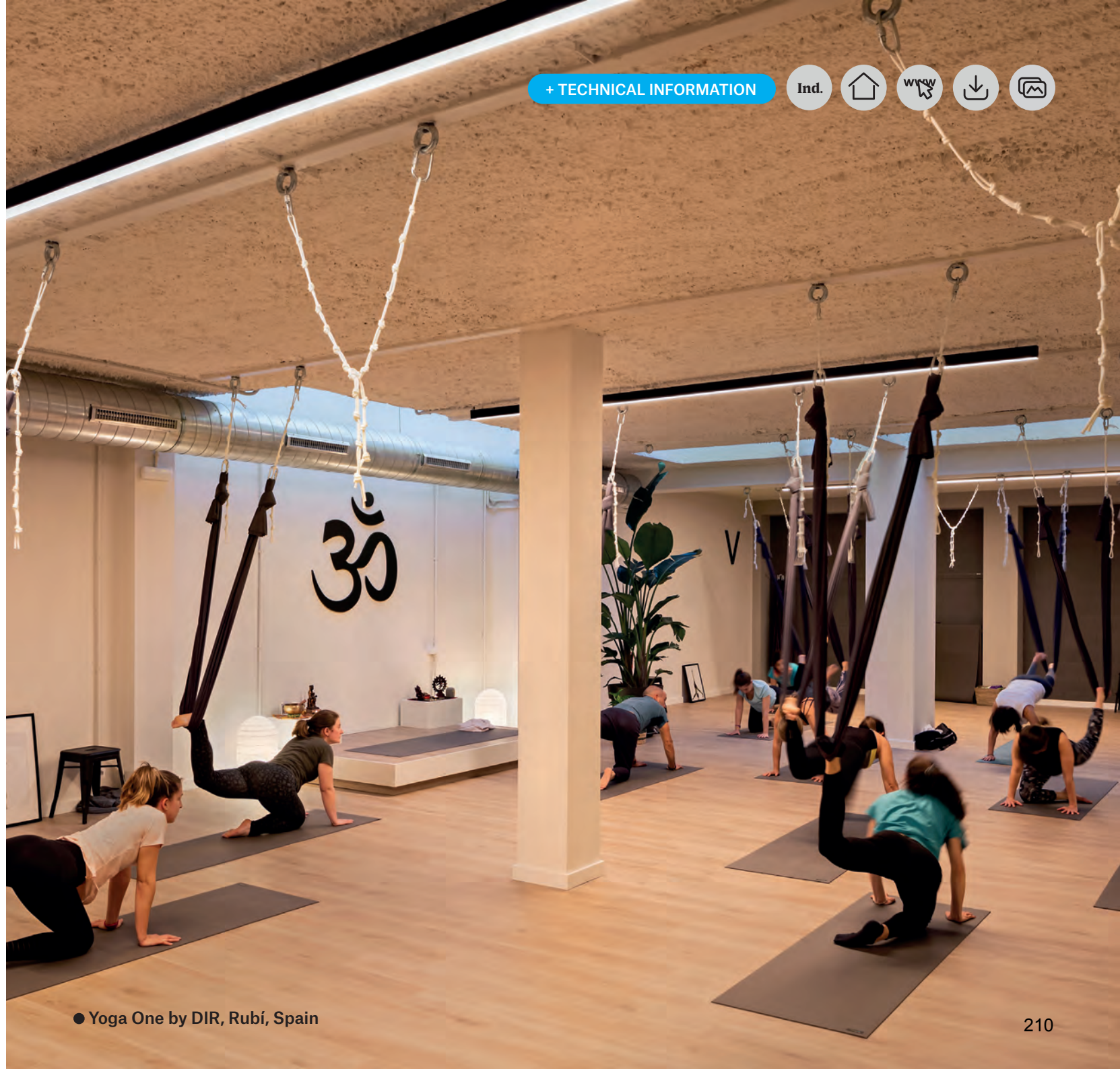



Lamptub 60

"The most adaptable luminaire to constantly changing spaces"

The renewed expression of a classic family that adapts to the needs of demanding spaces in constant evolution thanks to its lighting versatility and its multiple installation options.

Design by Lamp





Visual comfort Lamptub 60 Tech

Luminaire classified as "risk-free" RG0 according to the Photobiological Risk standard UNE 62471. Opal diffuser and opal comfort. Available in models with opal comfort diffuser for lower light distribution and glare control UGR19. Maximum visual comfort versions available in low luminous flux models (LO versions) with UGR lower than 15.



Versatility

Different light distributions, direct and direct and indirect. Available colour temperatures: 2700K, 3000K and 4000K with CRI 90 or Dynamic White (2700-6500K).



Flexible lighting

Multiple installation possibilities: track surface or suspended for integration in NOMADIC System, suspended with recessed or surface-mounted trim.

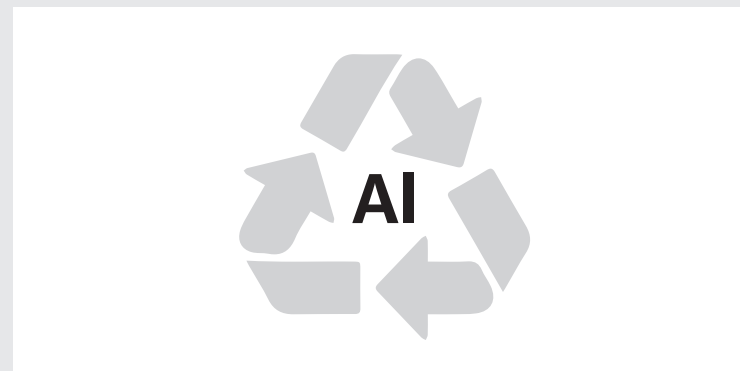

Sustainability

Designed under a circular economy concept that facilitates the recovery and reuse of the luminaires. Made from recycled extruded aluminium.

Lamptub 60 | Indoor

+ TECHNICAL INFORMATION

Ind.



Models	SUS. DIR. REC	SUSP. DIR. SUR	TECH	SUS. DIR/IND. REC	TRACK DIR. SUR	TRACK DIR. SUS	TRACK DIR/IND. SUS		
Dimensions	DIRECT	DIRECT / INDIRECT		DIRECT	DIRECT / INDIRECT				
Lengths	840mm	1120mm	1680mm						
Lm LED	1500lm	2600lm	3000lm						
CRI	90								
Beam angle	Opal	Opal Comfort	Tech	Dir/Ind Opal	Dir/Ind Opal Comfort	Opal	Opal Comfort	Dir/Ind Opal	Dir/Ind Opal Comfort
Color temp.	2700 / 3000 / 4000 K/TW				2700 / 3000 / 4000 K				
Gear	ON/OFF - DALI								
Power									
Finishes	○ White ● Black								
Wellbeing Palettes	● 4050-R90	○ 1505-Y10R	● 7024	● 4030-B50G	● 7001				
Be Social Palettes	● 4050-R90	● 1050-B10G	● 7502-R	● 7502-R	● 2011				

TECH ULTRACOMFORT

Design by Lamp

LAMPTUB 60





Lamptub 60

+ TECHNICAL INFORMATION



Comfort and wellbeing



VISUAL HEALTH

UGR 12

Active glare control through **TECH ULTRACOMFORT** optics.

Flicker free.



MATERIALS

40% reduction of the CO₂ footprint in manufacturing thanks to the use recycled aluminium.



EFFICIENCY

Up to **99 lm output/W.**



CIRCULARITY

Conceived under 3R Criteria:

Reduction of materials: thanks to its miniaturisation.

Reuse: includes recycled materials of post-industrial origin.

Recyclable: designed to improve its separability and recyclability at the end of its life cycle, and ease of maintenance.



ENVIRONMENTAL PRODUCT DECLARATIONS

Based on UNE 15804.

Which quantifies the impact on the carbon footprint considering the entire product life. Providing information for the LCA (Life Cycle Assessment) of the building.

Lamptub 60

+ TECHNICAL INFORMATION

Ind.



NS Nomadic System

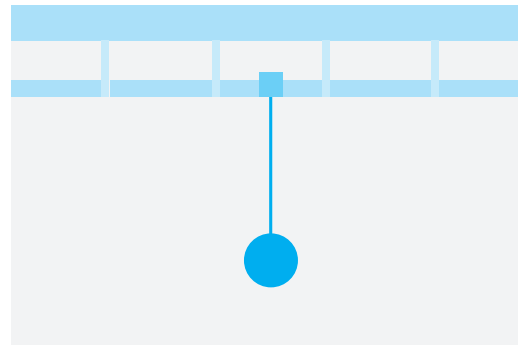

Spaces with hidden installations (continuous false ceiling).

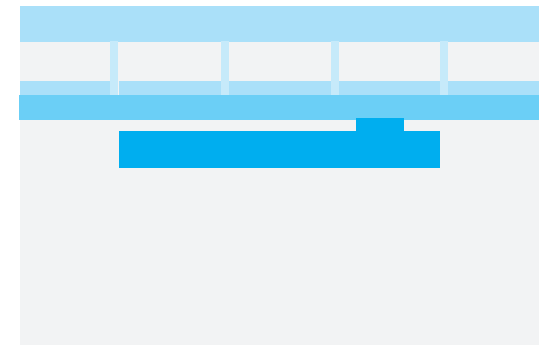

Spaces with view installations (metal tray).

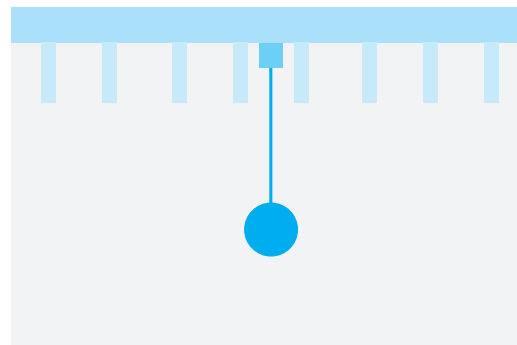

Spaces with hidden installations (slatted false ceiling).



Spaces with view installations (multi-format ceilings).





Models	SUS. DIR. REC	SUSP. DIR. SUR	TECH	SUS. DIR/IND. REC	TRACK DIR. SUR	TRACK DIR. SUS	TRACK DIR/IND. SUS		
Dimensions	DIRECT	DIRECT / INDIRECT		DIRECT	DIRECT / INDIRECT				
Lengths	840mm	1120mm	1680mm						
Lm LED	1500lm	2600lm	3000lm						
CRI	90								
Beam angle	Opal	Opal Comfort	Tech	Dir/Ind Opal	Dir/Ind Opal Comfort	Opal	Opal Comfort	Dir/Ind Opal	Dir/Ind Opal Comfort
Color temp.	2700 / 3000 / 4000 K/TW				2700 / 3000 / 4000 K				
Gear	ON/OFF - DALI								
Power	10 W	12 W	17 W						
Finishes	○ White		● Black						
Wellbeing Palettes	● 4050-R90	○ 1505-Y10R	● 7024	● 4030-B50G	● 7001				
Be Social Palettes	● 4050-R90	● 1050-B10G	● 7502-R	● 7502-R	● 2011				

Lamptub 60

+ TECHNICAL INFORMATION

Ind.





Lamptub 80

"A classic reinvented by Lamp"

If you take a look at the most iconic Lamp products, you will doubtlessly encounter the Lamptub, a product developed over 25 years ago. After being updated with new technology, this general lighting product has gone from a basic to a classic.

Design by Lamp



Lamptub 80



+ TECHNICAL INFORMATION

Ind.





Health Solutions: Clinic & Clinic Gas

Family of hospital headboards with a neutral, minimalist design, ideal for integrating in the space and giving centre stage to the light.

Clinic and Clinic Gas are luminaires that can be customized according to the needs of each project, with the possibility of direct, indirect and reconnaissance lighting, and with a wide range of mechanisms which are always integrated in the top or bottom of the profile in such a way as to be concealed. The Clinic Gas model, also allows the housing of the medical gas outlets in an independent channel, giving great accessibility and usability. This family of bed head units is designed both for hospitals and clinics, and for residences and health centres.

Design by Lamp



+ TECHNICAL INFORMATION

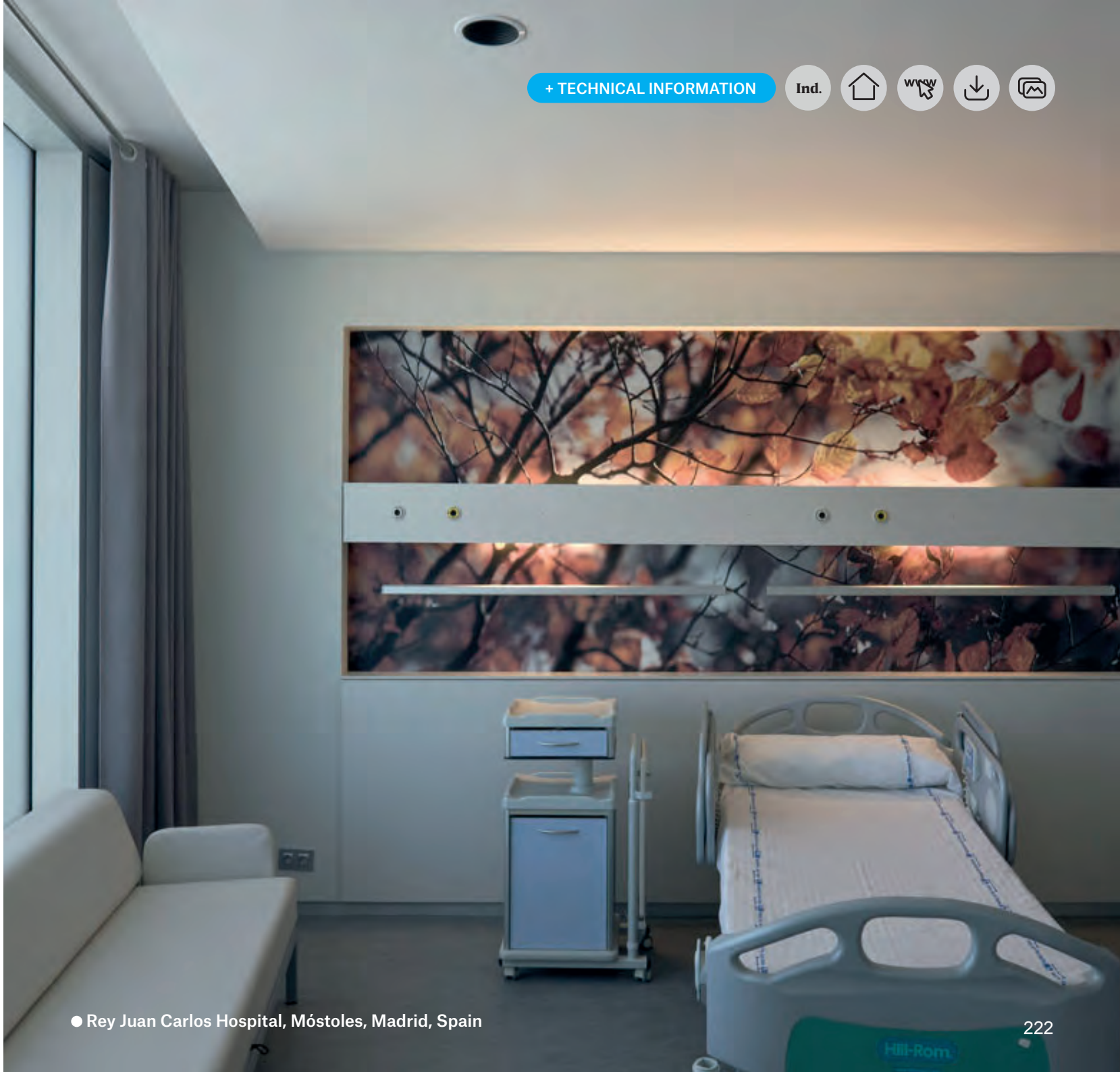



Transport Solutions

Designed specifically for installation in areas conditioned for pedestrian traffic, such as public transport stations.

Made of extruded aluminium, they are robust but flexible modular systems, with the possibility of integrating emergencies, loudspeakers and low voltage electricity lines, separated from each other by various pipes inside the luminaire.

As in the case of the luminaires designed for the Santiago de Chile, Barcelona and Toulouse metro, similar luminaires can be designed according to the needs of the project.

Design by Lamp

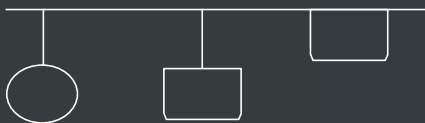

+ TECHNICAL INFORMATION

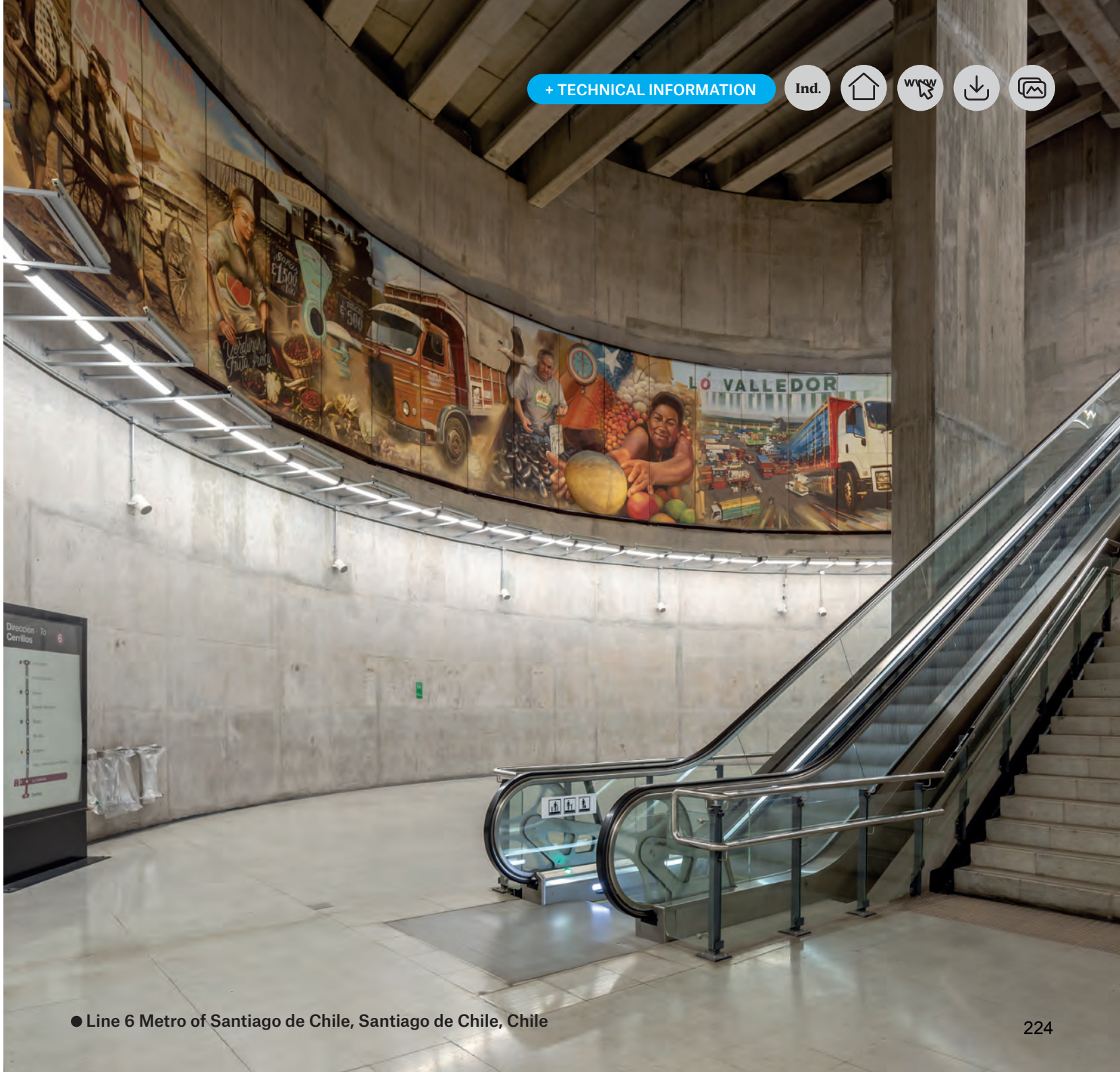



Seti

"More than just a sculpture"

More than an outdoor bollard, Seti is a vertical lighting system that was designed with the goal of covering an infinite number of constructive possibilities and lighting layouts.

Design by Antoni Arola

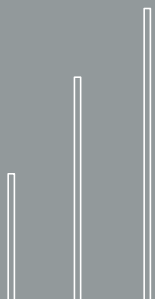

Lamp Worktitude for light





Formal elegance

Dimensions reduced to the minimum expression, slim design with a section of 39mm x 120mm.

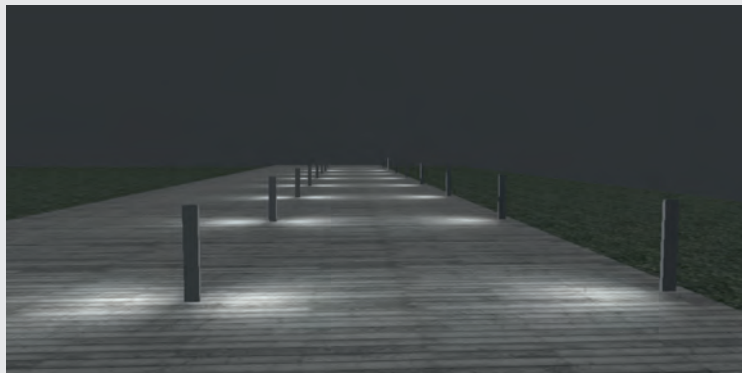

Wide range of lighting effects

Two lighting applications

Individual: illuminates the horizontal plane unidirectionally.

Double: illuminates the horizontal plane bidirectionally.

Two optics options

Spot: illuminates on the horizontal surface with a high contrast on the illuminated and unlit surface

Soft: the product takes presence and generates a more blurred light on the horizontal surface.

Lamp Worktitude for light

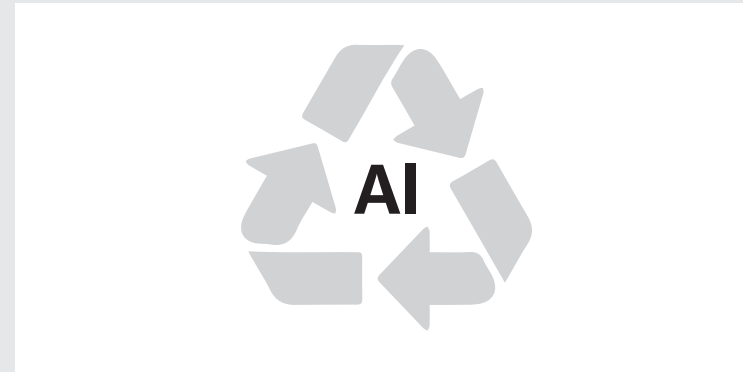

#Worktitude For Life

Product made of recycled aluminium extrusion at a rate of 80-85%, reducing the carbon footprint of products and processes, as well as the environmental impact across the entire value chain.



Variety of finishes

“Different finishes and combinations with white-black, and anthracite-black. Finishing of the different product in the internal and external part, which generates a differentiation in the perception of the different planes. Possibility to customize the color.”



Models

SOFT



SPOT



Dimensions

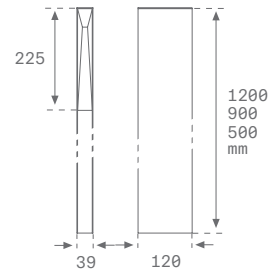
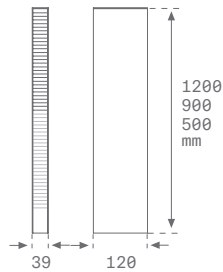

Lm LED 200 lm - 1000 lm

CRI 80

Beam angle

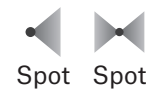

Color temp. 3000 K

Gear ON/OFF

Power 3 - 9 W

Finishes ● Anthracite 01 ● Black 03

+ TECHNICAL INFORMATION

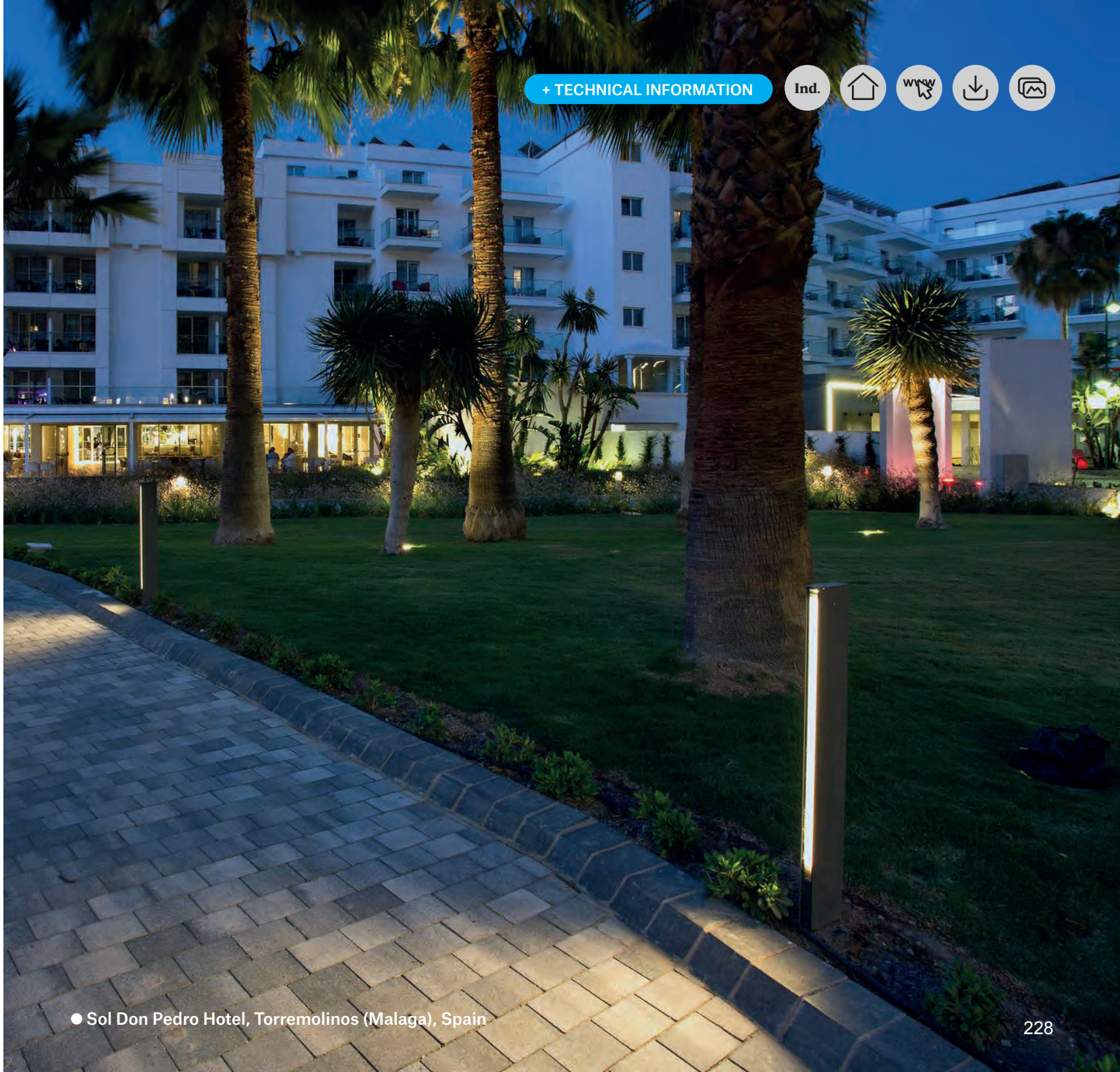



B-Side

“Disruptive technologies in product design”

A concept based on the idea that the object itself can collect the light that it generates, enhancing the product’s character as an ambient element. The LED light allows for a lightweight design which is adapted for function, contributing to its aesthetic and functional value.

Design by Lamp





Versatile lighting effects

The B-side family enables the possibility of bollards with bi-directional lighting flush to the ground, also at different heights to bathe outdoor areas such as passages or routes. There is also a version with a 360° lighting effect.

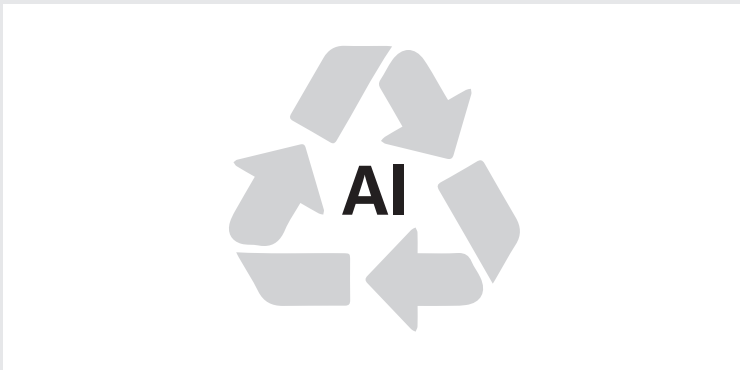

#Worktitude For Life

Product made of recycled aluminium extrusion at a rate of 80-85%, reducing the carbon footprint of products and processes, as well as the environmental impact across the entire value chain.



Tamper-proof and anti-corrosion







Its robust construction (IK10 and IP65) makes it safe and solid for public spaces, as its structure remains intact in case of any outside impact or attack. This makes B-Side LED an excellent vandal-proof solution to light public parks, gardens and different urban areas. It is made of aluminium extrusion, injected, and lacquered in grey textured polyester. Its base has an anti-corrosion treatment, which enables to be installed on any type of surface.

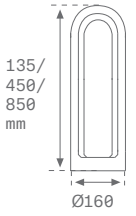
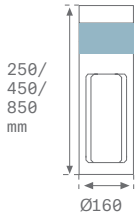

Improved efficiency

The second generation of B-SIDE beacons has achieved a 45% increase in initial efficiency. The B-SIDE 360° and 180° models are a highly efficient lighting solution for outdoor walkways, with up to 65lm/W. Exceptionally uniform illumination of your outdoor spaces while reducing energy consumption.



Models	B-SIDE	B-SIDE 360°	
			
Dimensions			
Lm LED	93 lm - 171 lm	1200 lm - 1500 lm	
CRI	80		
Beam angle	 Spot	 180°	 360°
Color temp.	3000 - 4000 K		
Gear	ON/OFF		
Power	2 - 4,8 W	6 - 9 W	
Finishes	● Anthracite 01	● Grey 03	

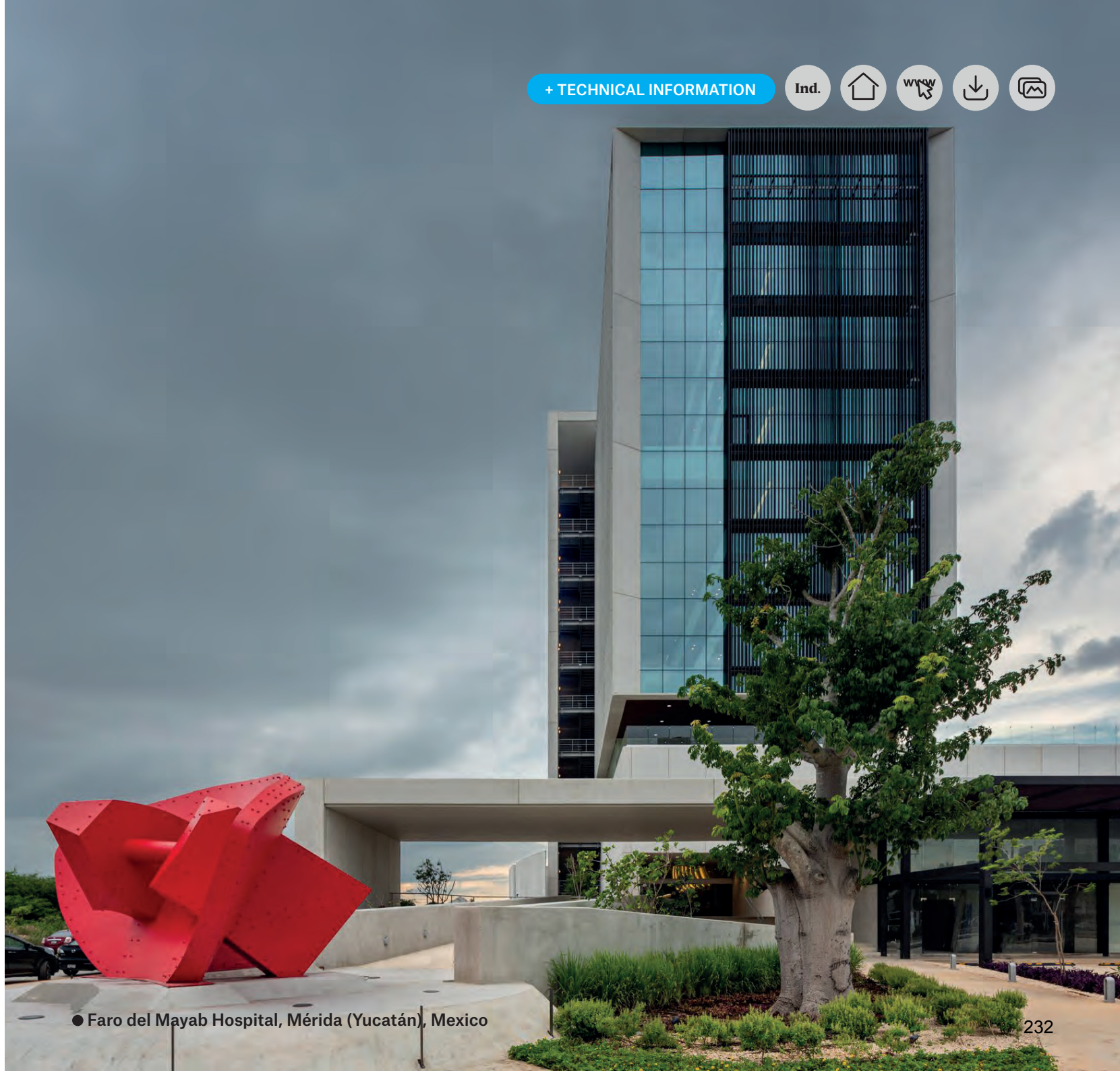



Puck

A concept based on the idea that the object itself can collect the light that it generates, enhancing the product's character as an ambient element. The LED light allows for a lightweight design which is adapted for function, contributing to its aesthetic and functional value.

Design by Wila

+ TECHNICAL INFORMATION

Ind.

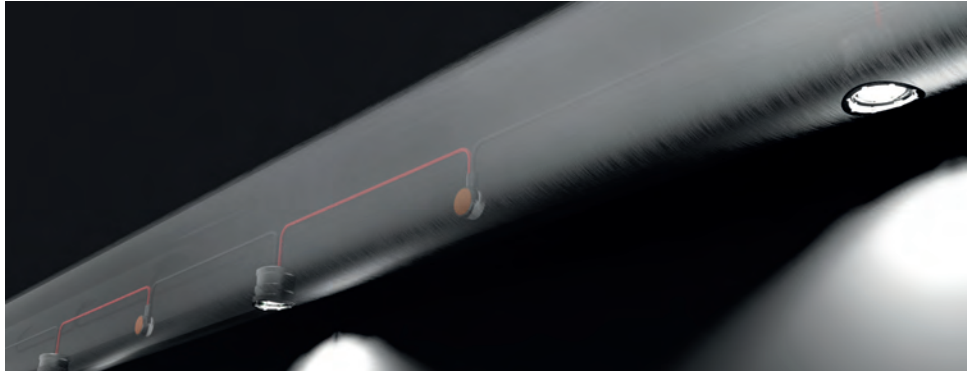

Lighting system for integration in railings
(round section)
Suitable for both indoor and outdoor installation

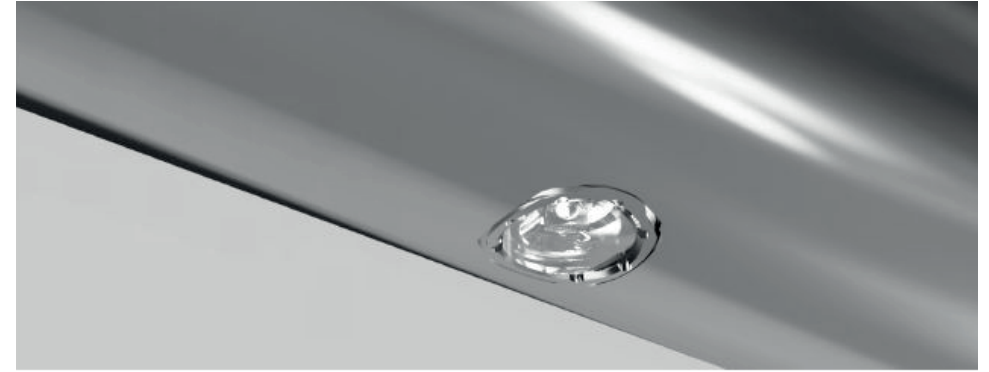

Diversity of applications and lighting versatility

Stainless steel luminaire bespoke polycarbonate lens specially developed for handrail applications, various photometric distribution options (**Symmetric; Double symmetric; Asymmetric**)
Colour rendering index CRI > 80 and availability of colour temperature 3000K and 4000K.
Efficiency: up to 123 lm/W



Durability and robustness

Corrosion protected stainless steel 316 V4A body luminaire;
Suitable for installation in marine environments;
IP66 rated for outdoor applications;
Vandal resistant IK10;
Lifetime of 50,000 hours (L80 B10);





Wurzburg University, Germany

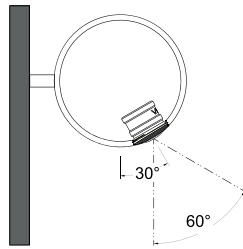

Symmetric Distribution



MP1201501

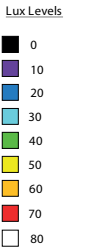
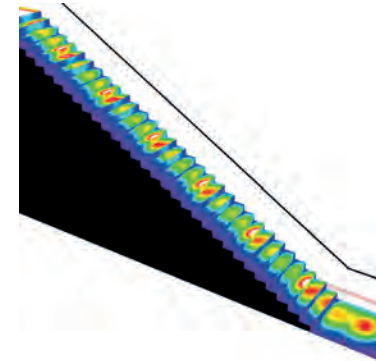

Halle District Cour, Germany

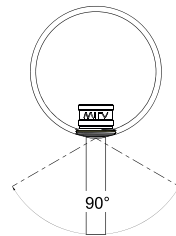

Double Symmetrical Distribution



MP1201503

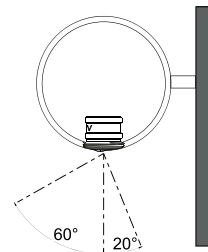
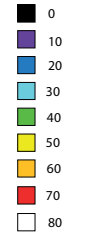
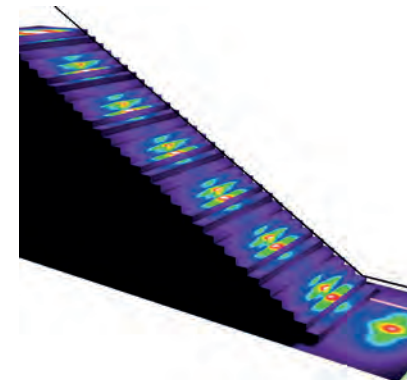

Asymmetric Distribution



MP1201505

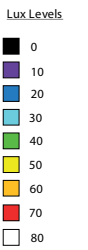
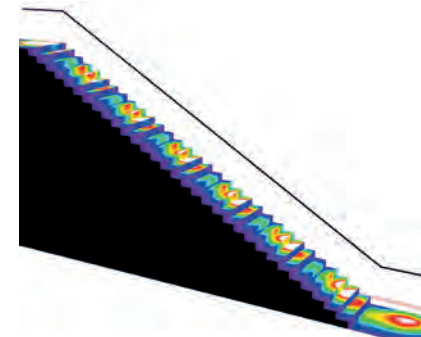



Lup

"Lighting designed to enhance the environment"

Under the same formal language, Lup Wall Mounted and Downlight provide both accent lighting and general lighting solutions for outdoor spaces, thanks to the optimization of their design that seeks to mimic the natural environment through greater light versatility.

Design by Diba Studio





Versatility

A family of downlights and wall lights that follow the same aesthetic line and formal coherence, by covering different applications.

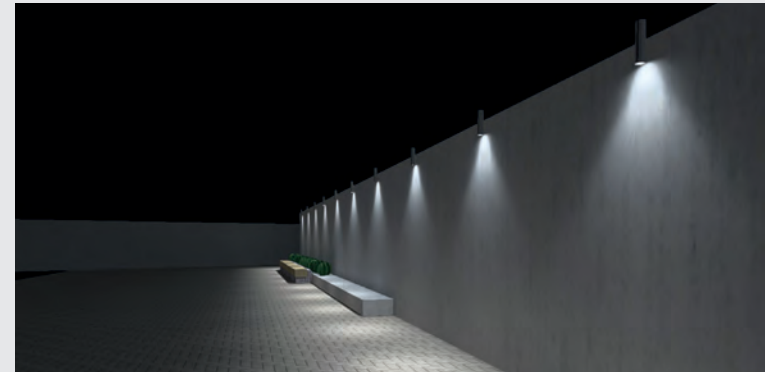

Versatile lighting effects: Symmetrical, Asymmetrical

Wall light available with direct and indirect lighting, or only direct lighting offers different optics; medium; spot and asymmetrical.



Compact design

Wall light with a minimalist, elegant and compact design, in which the joints disappear, reducing them as much as possible. This design enables perfect integration into any space.

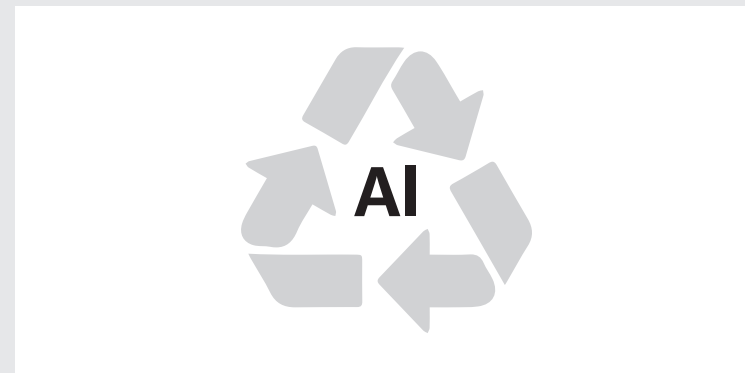

#Worktitude For Life

Product made of recycled aluminium extrusion at a rate of 80-85%, reducing the carbon footprint of products and processes, as well as the environmental impact across the entire value chain.



Models	ø 70	ø 110	ø 110	ø 162
Dimensions				
Lm LED	1000 lm - 3000 lm	1000 lm - 4000 lm	500 lm - 1000 lm	3000 lm - 4000 lm
CRI	80			
Beam angle				
Color temp.	3000 / 4000 K			4000 K
Gear	ON/OFF			
Power	9 - 12 W	23 - 33 W	5 - 8 W	23 - 30 W
Finishes	● Black 03			

Lup



+ TECHNICAL INFORMATION



Lamp Worktitude for light

● Madrid Offices, Spain



Gap

*“Architecture-enhancing lighting
for highly demanding applications”*

A project with an empirical design based on the study of spaces, minimising the height of the recessed light, and guaranteeing that watertightness does not depend on its installation, gave us the final model for this product.

Design by Diba Studio & Lamp





Versatile application: Uplight & Downlight

Special recessing ring to be installed in false ceilings with a decorative frame. It can also be recessed in floors and walls of shallow depth.



Compact: Height

Very compact design with a minimum recessing height, enabling this luminaire to be installed in multiple areas.



Adjustable Optics

Recessed adjustable uplight with tilting option to adjust the emitted light, and easy installation. This family can be used for spot, flood, and wide flood optics.



Models



Dimensions

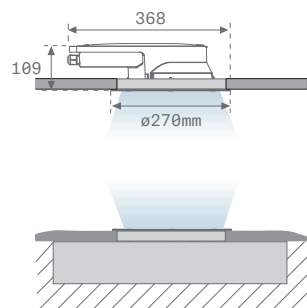

Lm LED	1400 lm - 3600 lm
CRI	80
Beam angle	
Color temp.	3000 / 4000 K
Gear	ON/OFF
Power	10 - 30 W
Finishes	● Inox 02





Trace 65

"Light reveals shape"

Searching for a way in which to illuminate spaces without the light source being visible, and taking inspiration from the light created by the moon during a solar eclipse, a new luminaire was created which reveals itself when it is turned on, creating a soft, diffused light that seems to come from within a line.

Design by Artec studio





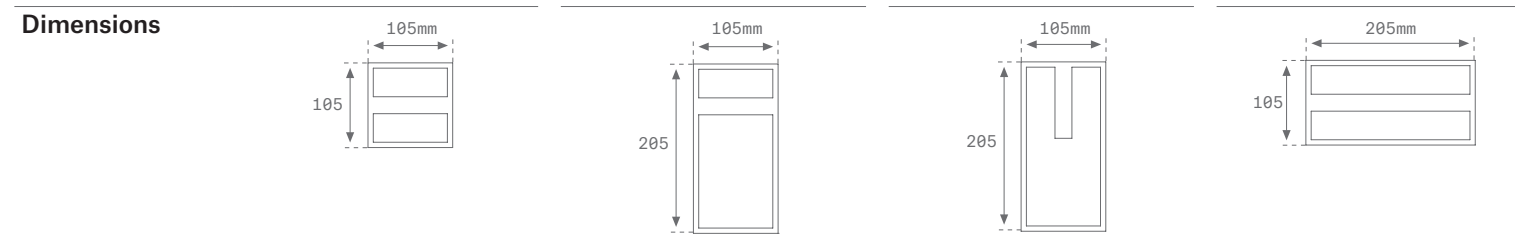

Lm LED	150 lm			300 lm
CRI	80			
Beam angle	 Sym.	 Asym.	 Asym.	 Sym.
Color temp.	3000 K			
Gear	ON/OFF			
Power	1 W			3 W
Finishes	● Black 07			

+ TECHNICAL INFORMATION

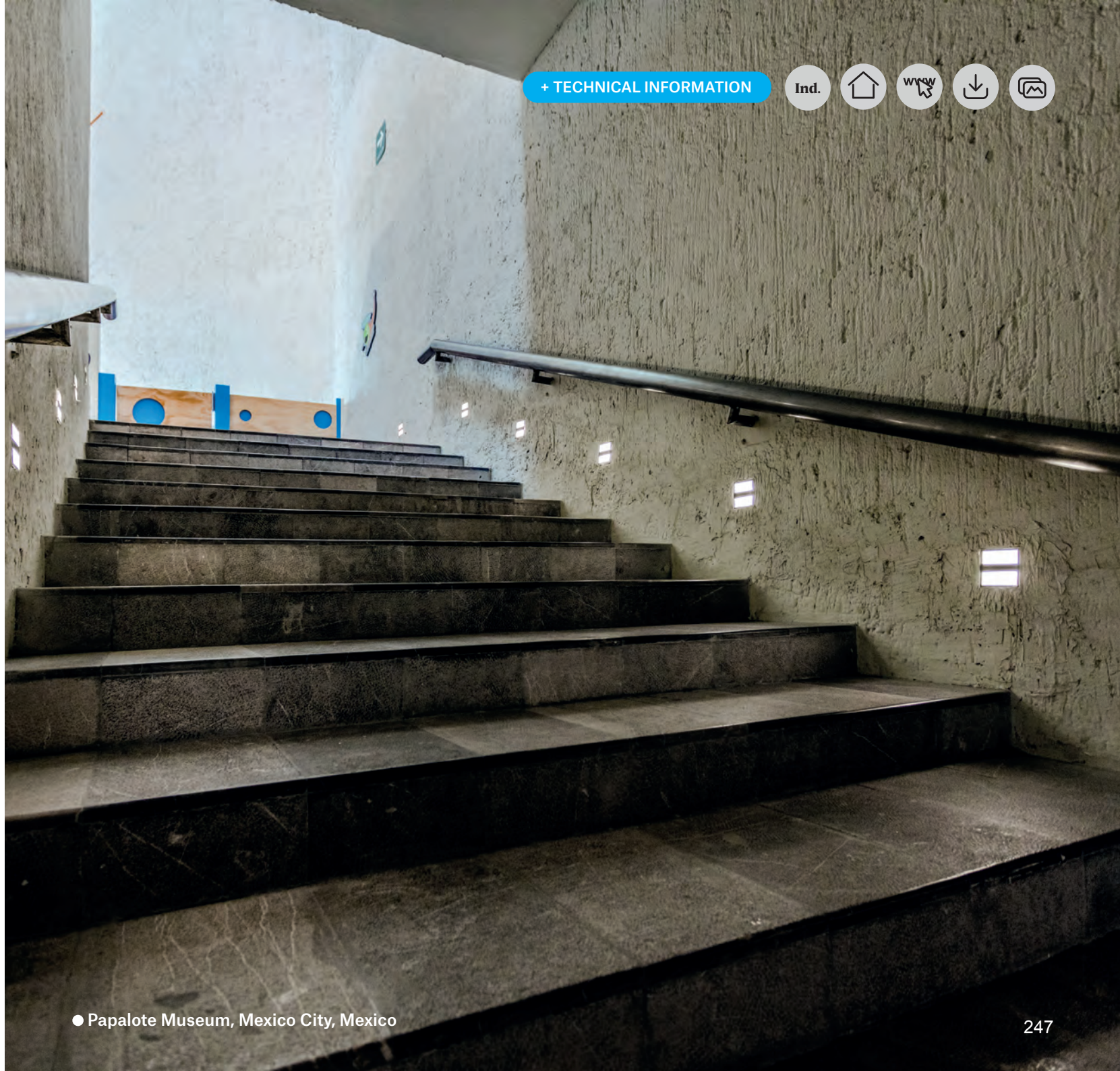



Duit

"Greater than the sum of its parts"

Scalable lighting programme around a lighting unit that, when combined with installation accessories and optics, creates an ecosystem of outdoor solutions with a holistic and environmentally friendly approach.

Design by LA INVISIBLE LAB



Diffuser



Antiglare

Main Profile



Fixing clip

Optiques



Led Module



Side Cover

Reflector Profile

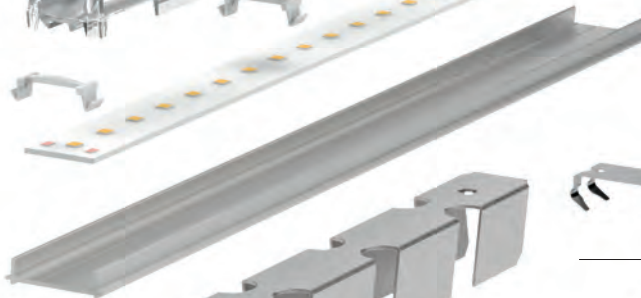

Fixing spring

Box cover with sealing gasket



Connector



Junction box



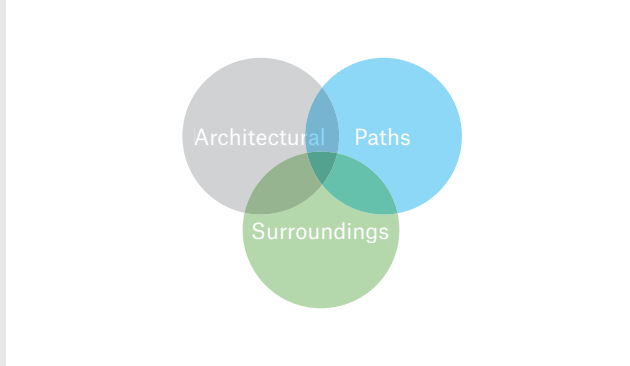

Highly versatile and configurable system:

By selecting a lighting module with multiple photometry versions and combining it with different installation and optical accessories, DUIT becomes a lighting solution capable of meeting most of the lighting requirements of systems for architectural lighting (facades), user environment lighting, or pathway lighting.

Integration:

By optimising its dimensions, a high integration and interaction with any outdoor space can be achieved without compromising the technical aspects of the product. Thanks to its minimally intrusive anchoring systems, it can be installed in both new construction and renovation projects, reducing the visual impact.

Scalable and separable system:



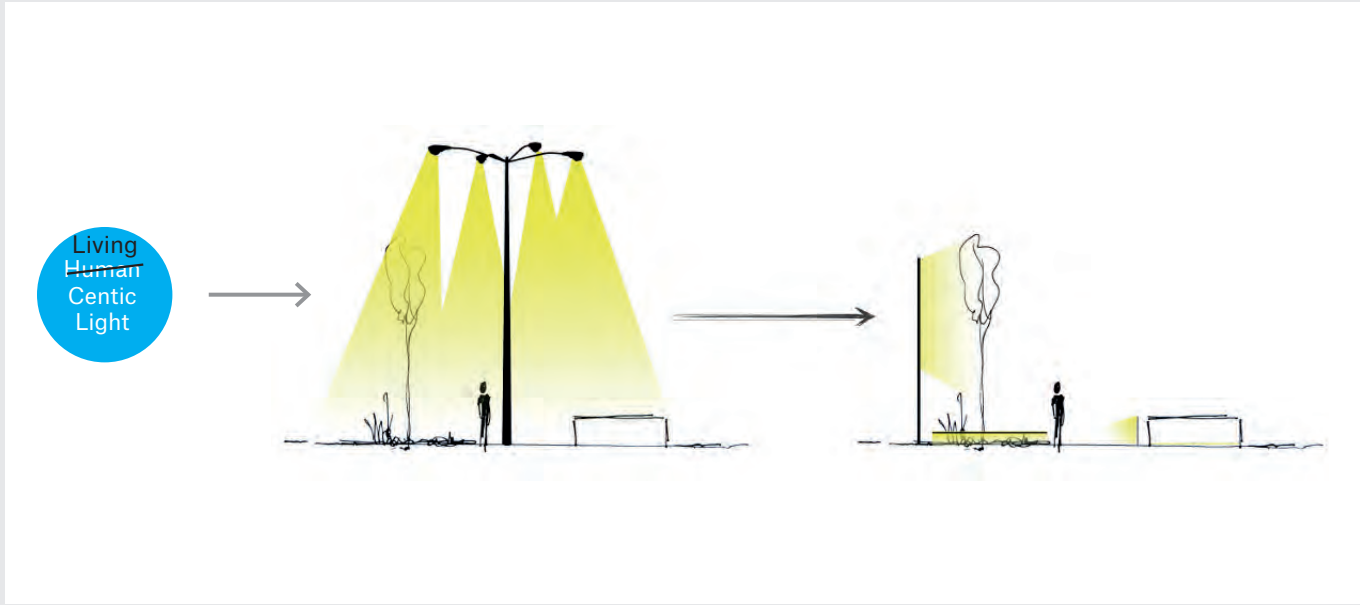





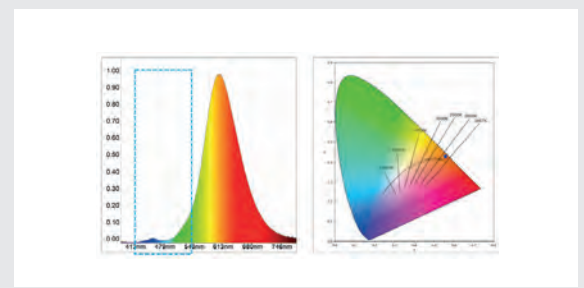

The range has been conceptualised to create a scalable solution that can be mechanically and technologically upgraded. Its piecemeal design facilitates sorting materials, which can then be recovered and recycled.

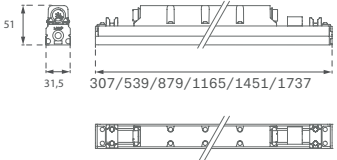
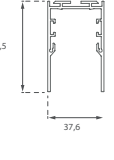
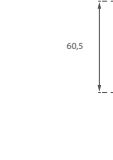
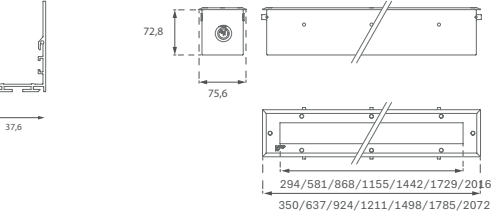
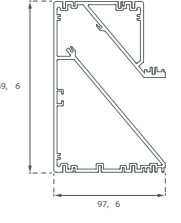
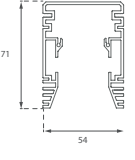

Living Centric light:

DUIT facilitates close lighting planning, bringing the light source closer to the action or element to be lit, thus creating much more pleasant lighting atmospheres, while reducing energy consumption. It has an amber option with a light spectrum that is extremely respectful of the environment and ecosystem.



Models	LIGHT ENGINE	ACCESSORIES					
		BASIC		INTEGRATION		MINIMUM	
		SURFACE	INDIRECT	RECESSED	REC. ASYM	TRIMLESS	ANCHORS
							
Dimensions							
Lm LED	1000 lm - 2160 lm						
CRI	80						
Beam angle	 WF  WW  GZ  OP						
Color temp.	2700 / 3000 / 4000 K / Amber						
Gear	ON-OFF/DALI						
Power	1,3 - 23,4W						
Finishes	● Black 06						

Configuration









1. Light Engine

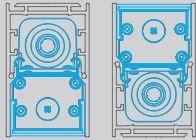

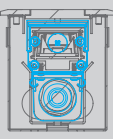
Driver

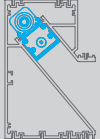

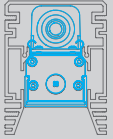
2. Installation accessories

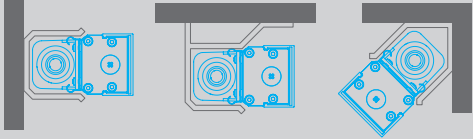
Basic	Surface	 
	Recessed	 
Integration	Recessed Asymmetric	 
	Trimless	 
Minimum	Surface	 



3. Optic Accessories

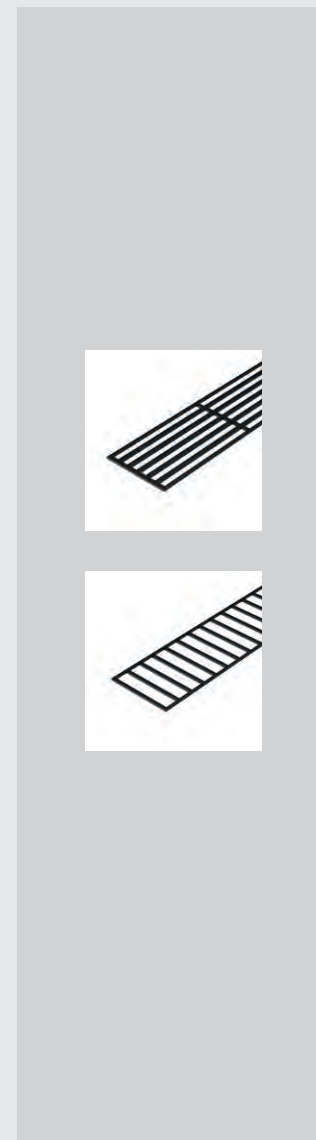

Living Centric Light

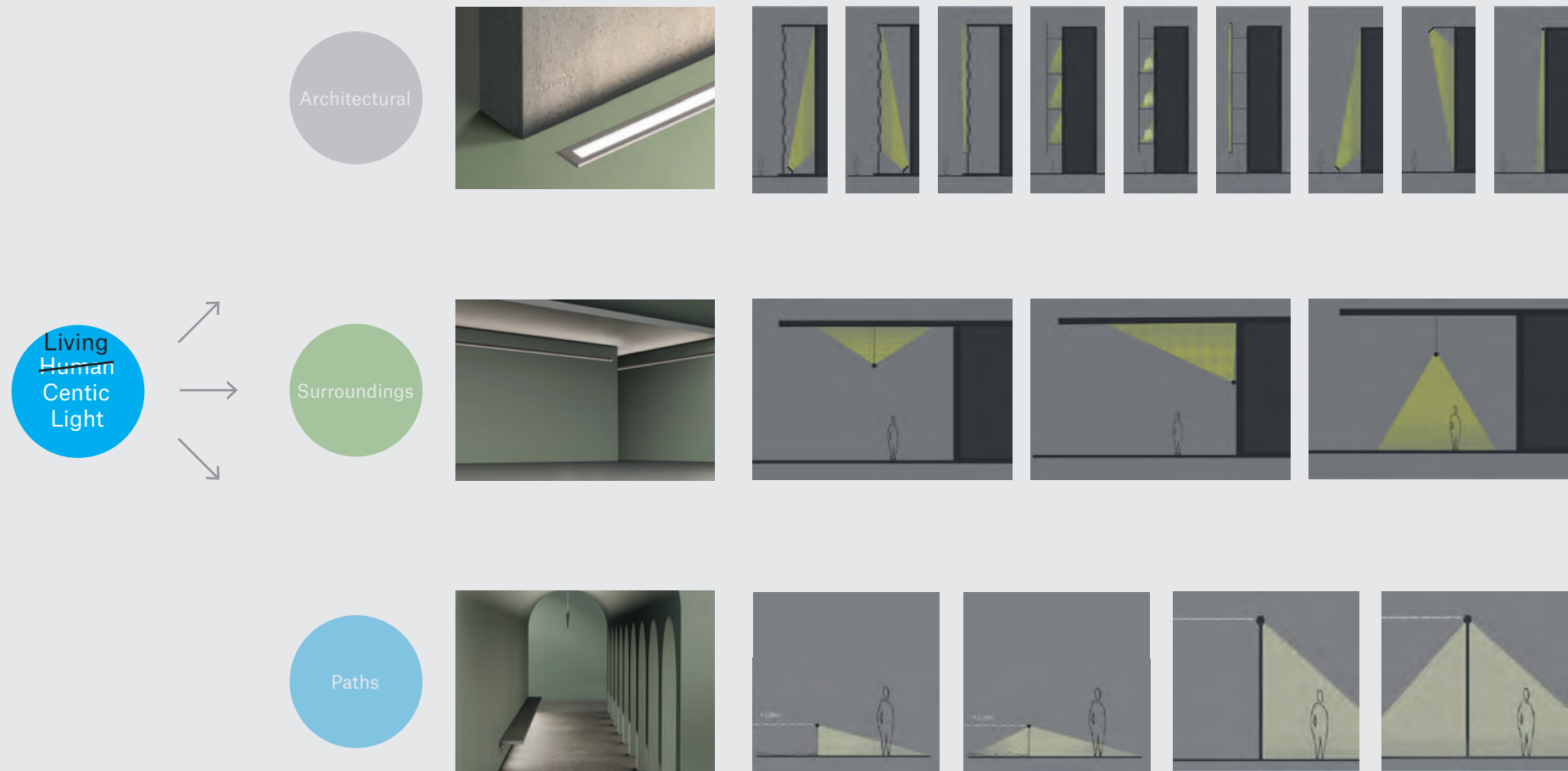

Living
Human
Centric
Light

Architectural

Surroundings

Paths



Basic Surface

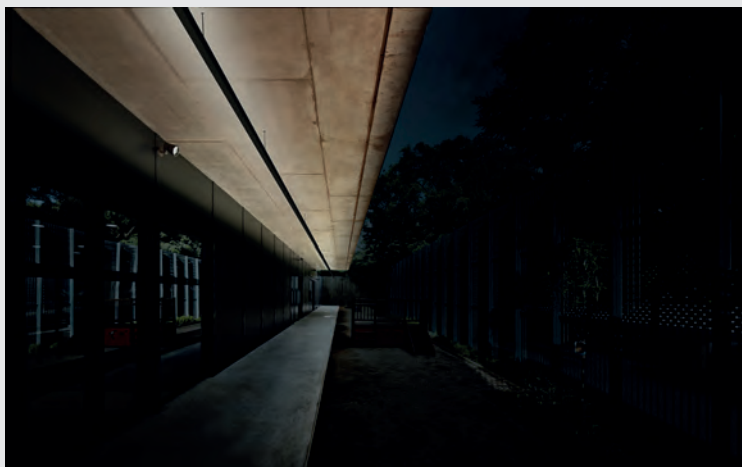
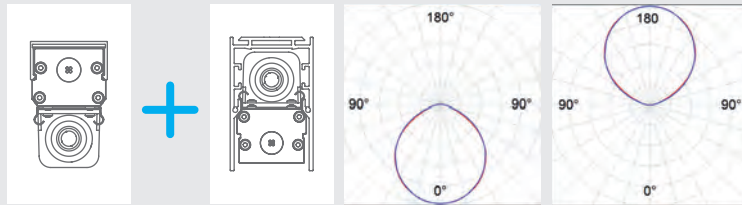

Lamp Worktitude for light

Basic Recessed

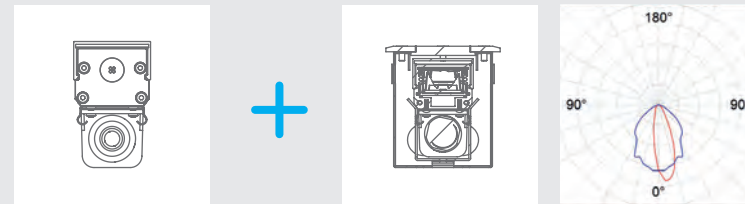



Integration Trimless

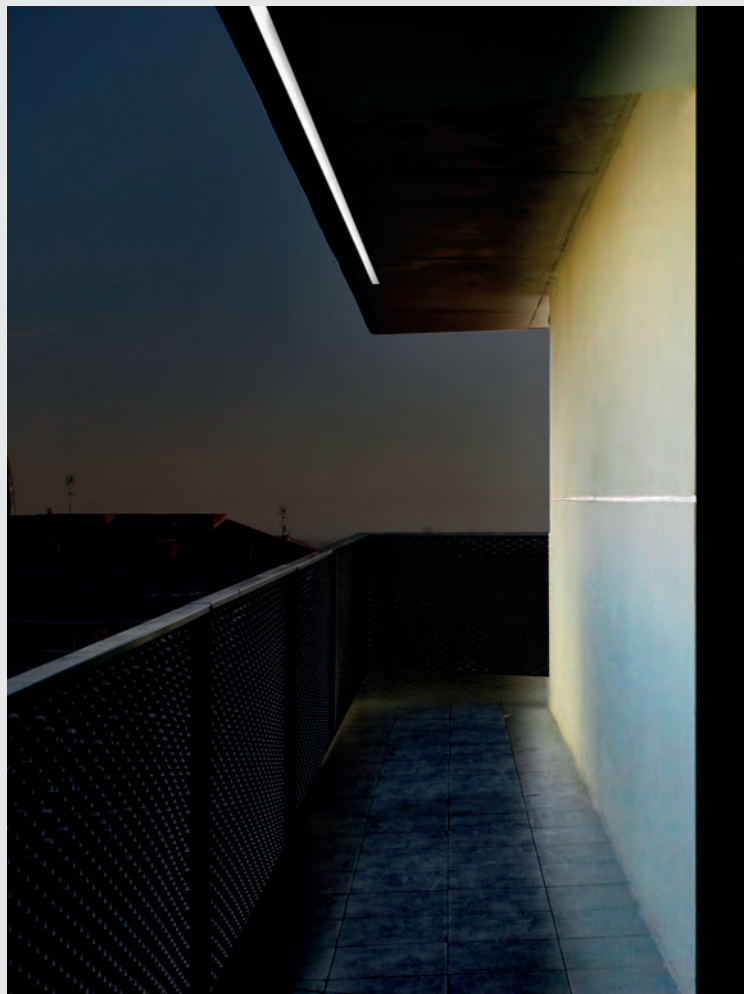
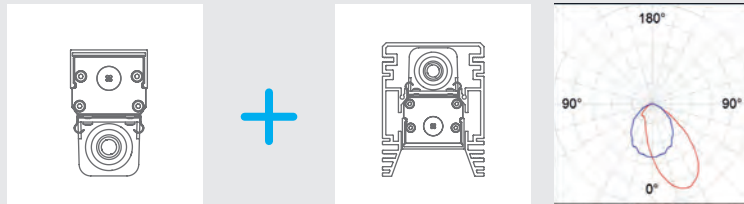

Lamp Worktitude for light

Integration Asymmetric

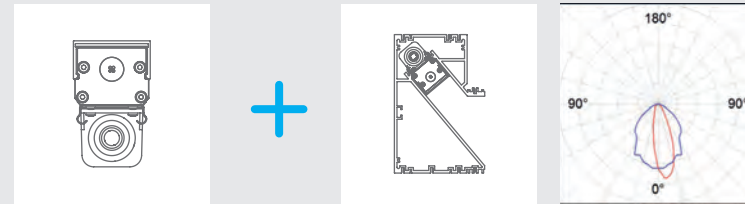



Bazz

"Uniform lines of light"

Bazz is born from the need to provide uniform lighting and facilitate the installation of outdoor linear applications. It is a product with technical character and a broad range of options that provide concrete solutions to a wide variety of architectural applications.

Design by Lamp





Application versatility

This family is designed to provide solutions for different installation methods; both recessed and surface mounted. The end caps are made of aluminium injection and enable the luminaire to be inclined, to direct the light where it is most suitable in each application.



Ease of installation

Quick and watertight connectors on the end caps of the luminaire enable easy and convenient installation.

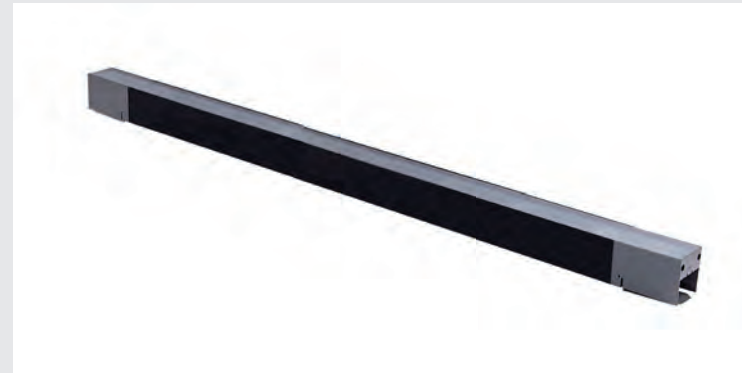

Continuous lines

In addition to the standard lengths, this luminaire is designed for installation in continuous lines and customisation of its lengths.

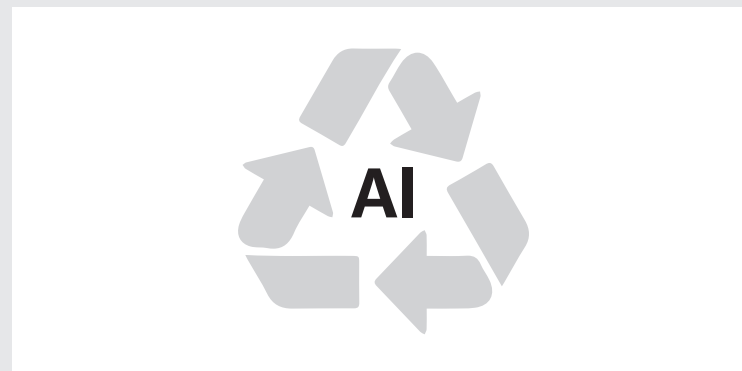

#Worktitude For Life

Product made of recycled aluminium extrusion at a rate of 80-85%, reducing the carbon footprint of products and processes, as well as the environmental impact across the entire value chain.



Models	RECESSED				AIR			
	SYM	ASY	WW	OPAL	SYM	ASY	WW	OPAL
Dimensions	<p>RECESSED</p>				<p>AIR</p>			
Lm LED	1980 lm - 8100 lm				4200 lm			
CRI	80							
Beam angle								
Color temp.	3000 / 4000 K		3000 / 4000 K		3000 / 4000 K		3000 / 4000 K	
Gear	ON/OFF							
Power	19 - 75 W		37 - 75 W		31 - 63 W		19 - 75 W	
Finishes	● Black 06							





Bauline

"The linear spotlight"

It is a product characterised by its small size and versatile application. It can be used for side-lighting applications to emphasise a surface, to highlight textures, or to define spaces.

Design by Lamp

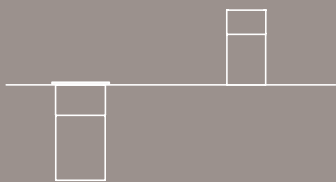





Models

RECESSED



SURFACE



Dimensions

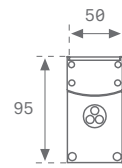
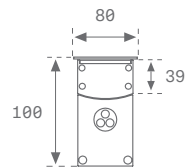

Lm LED 3600 lm - 5000 lm

CRI 80

Beam angle



Color temp. 3000 / 4000 K

Gear ON/OFF

Power 17 W

34 W

Finishes ● Grey 02

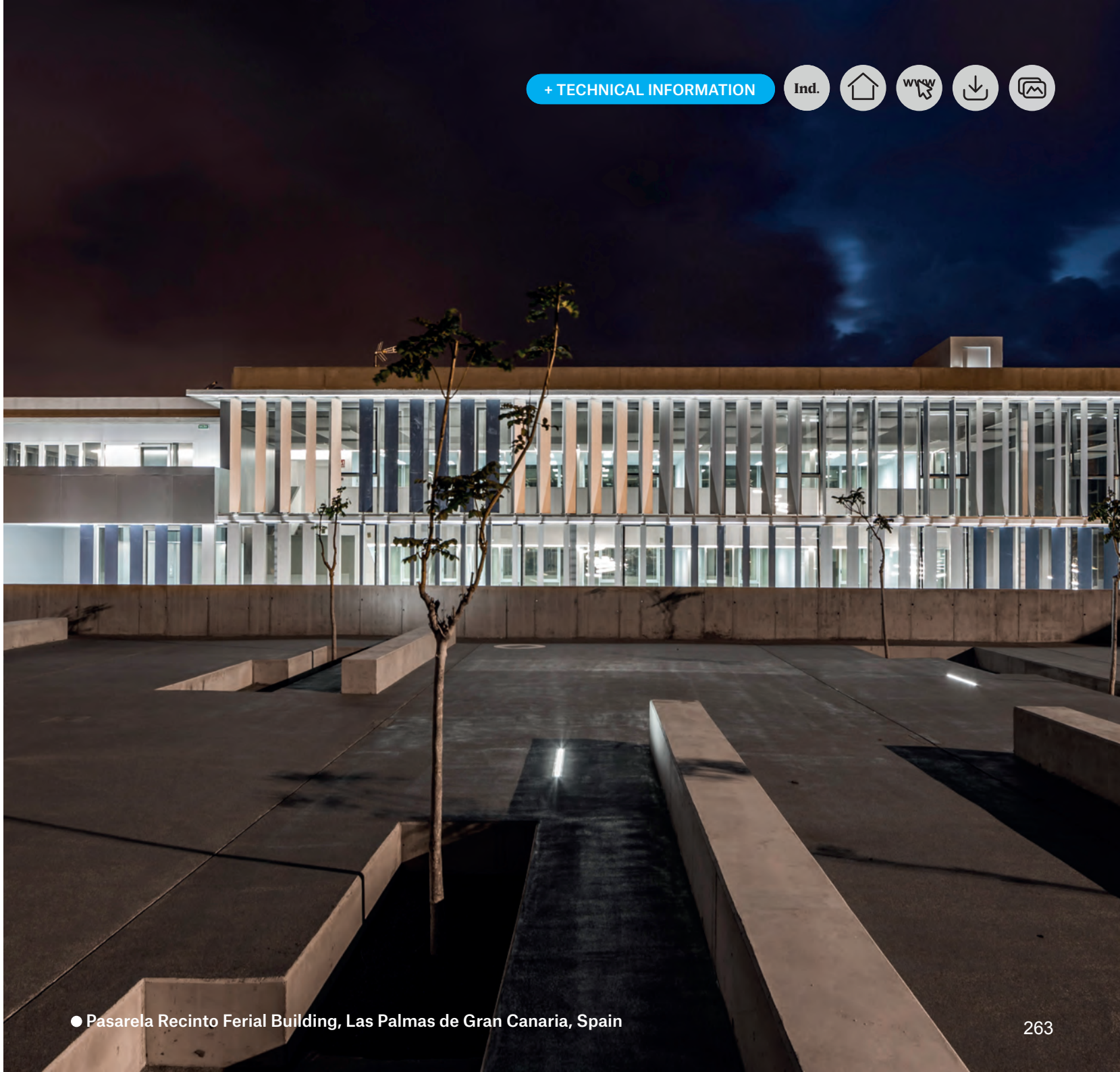



Flut

"Form follows function"

Flut is a clear example of the philosophy defended by the Bauhaus school and embodied in the famous phrase: "Form follows function." A family of products with a compact, neutral design and a wide array of solutions designed to simplify the installation process.

Design by Lamp

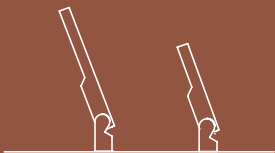



Multiple orientation possibilities

This family contains a ball joint to swivel between 90° and -30° in the desired direction, and contains an anti-condensation valve.



Wide range of accessories

It has a wide range of accessories, such as anti-glare fins, supports and clamps to create a Road System, with cone-shaped or cylindrical columns, ideal for lighting pedestrian areas.



Compact design.

The compact design of this luminaire integrates maximum efficiency in a very small space, allowing minimum impact on the environment.

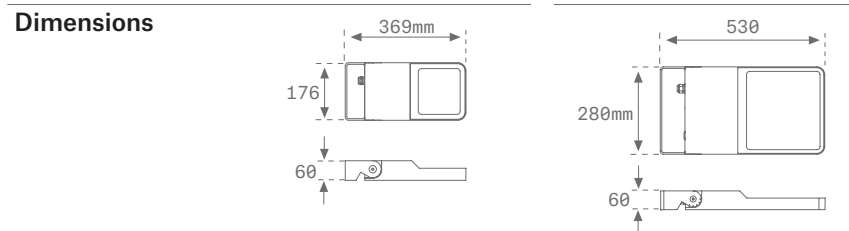

Lm LED	3000 lm - 5000 lm	9300 lm - 18700 lm
CRI	80	80
Beam angle		
Color temp.	3000 / 4000 K	
Gear	ON/OFF	
Power	23 - 44 W	54 - 117 W
Finishes	● Grey 03	● Anthracite 01

Flut

+ TECHNICAL INFORMATION

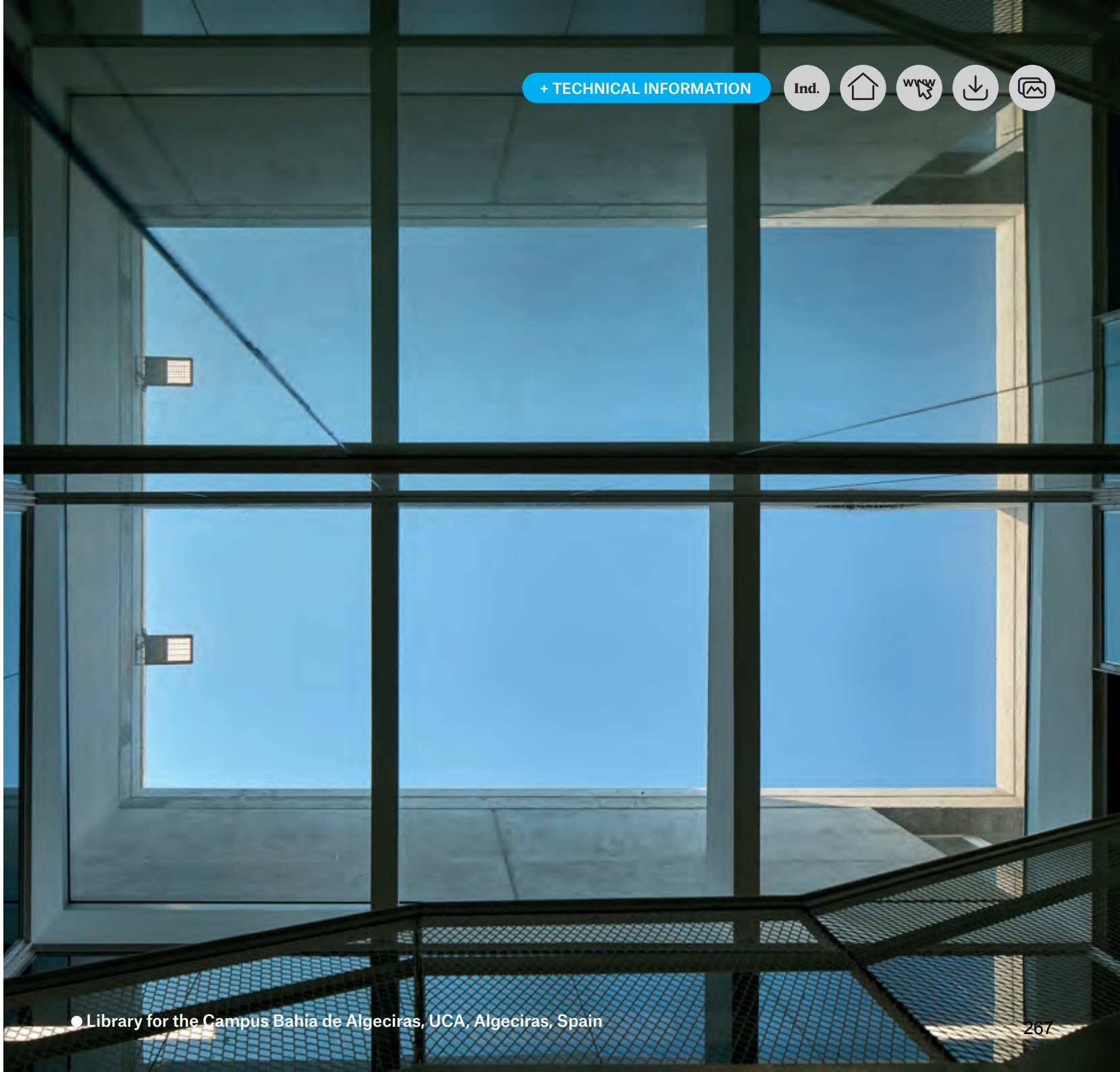

Lamp Worktitude for light

● Library for the Campus Bahía de Algeciras, UCA, Algeciras, Spain

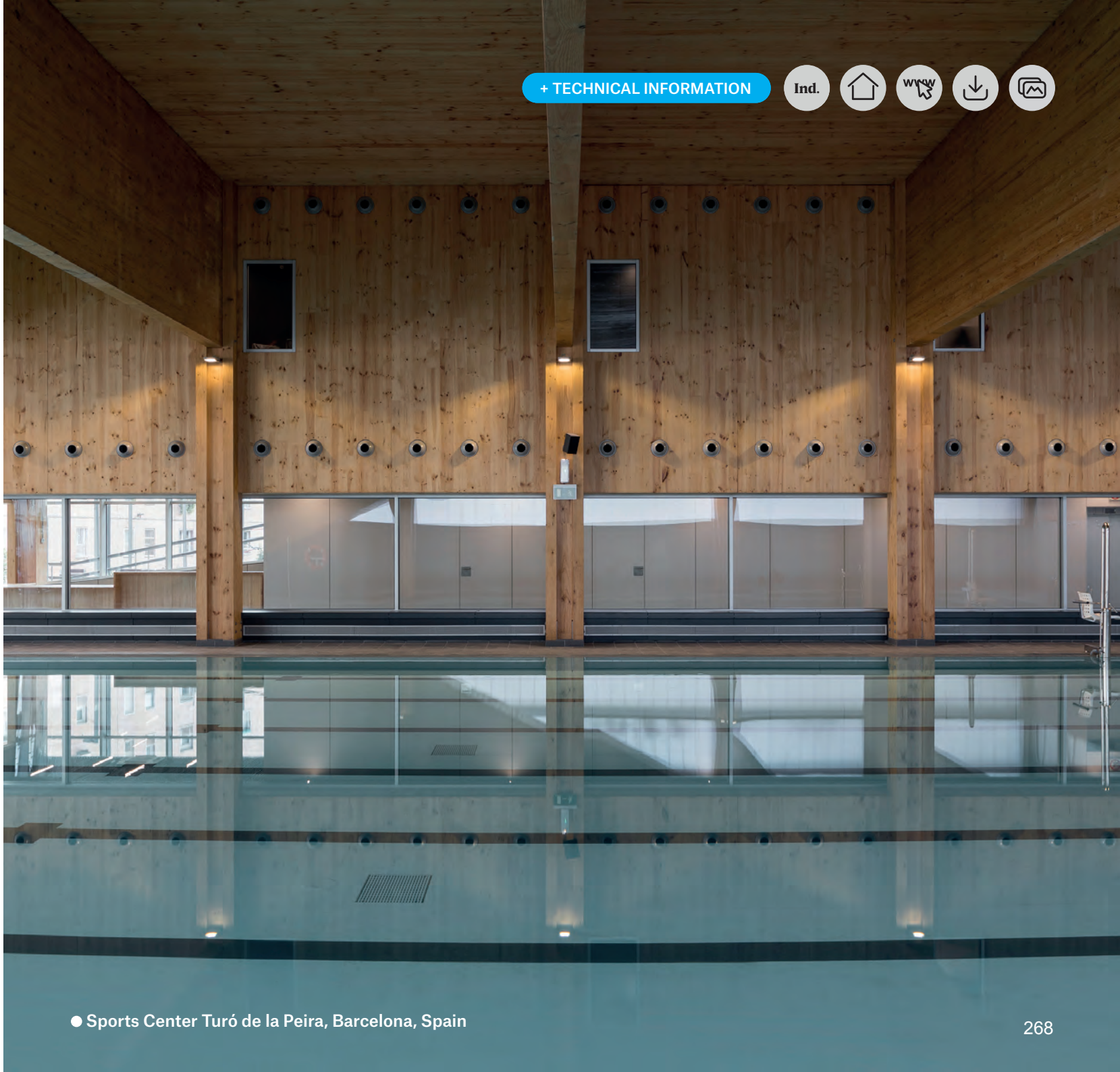



Shot

“Technical purity”

From a technical premise based on the performance and maintenance of the luminaire, a shape was designed for strictly functional purposes, such as temperature dissipation, without adding superfluous elements.





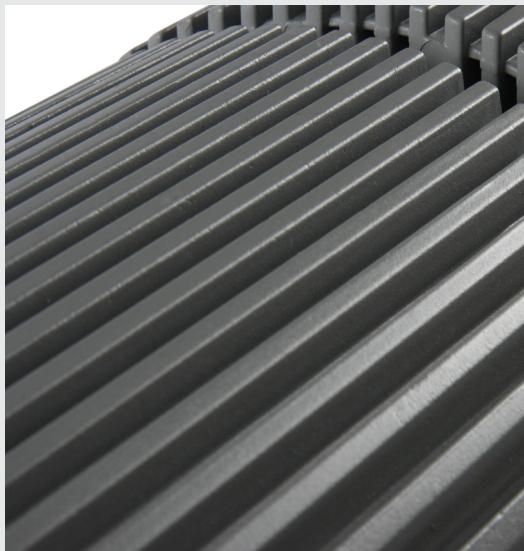



Design by Diba Studio & Lamp



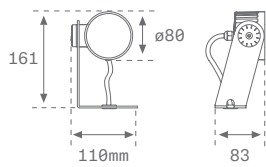
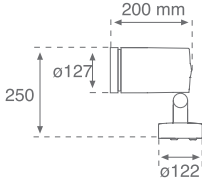
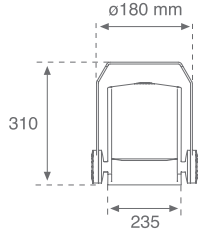
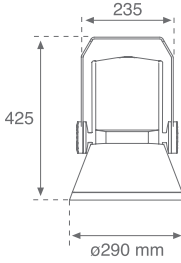
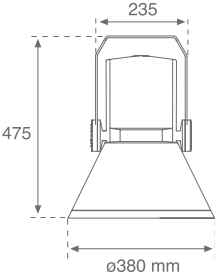

50% improved efficiency

The third generation of Shot 290 and Shot 380 goes from an average of 89.6lm/W to 136 lm/W, a 50% improvement in efficiency.

Models	SHOT 80	SHOT 120	SHOT 180	SHOT 290	SHOT 380
					
Dimensions					
Lm LED	900 lm	1500 lm - 3800 lm	5000 lm - 7000 lm	6500 lm	7000 lm - 10500 lm
CRI	80				
Beam angle					
Color temp.	3000 / 4000 K	2700 / 3000 / 4000 K			
Gear	ON/OFF - TRIAC				
Power	6 W	10 - 30 W	37 - 56 W	48 W	45 - 73 W
Finishes	● Grey 03	● Anthracite 01			

Shot

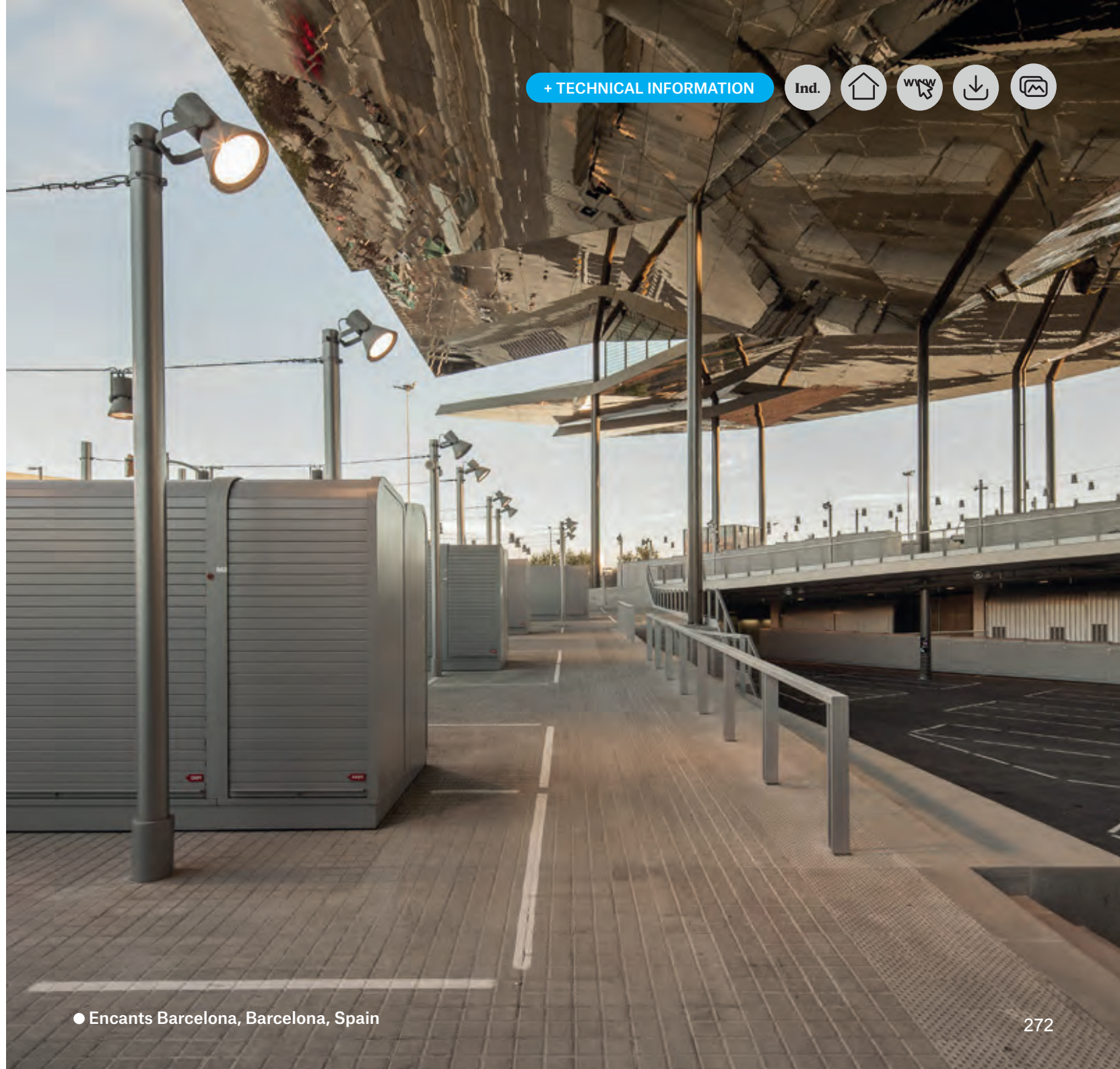

+ TECHNICAL INFORMATION



Lamp Worktitude for light

● Encants Barcelona, Barcelona, Spain

+ TECHNICAL INFORMATION

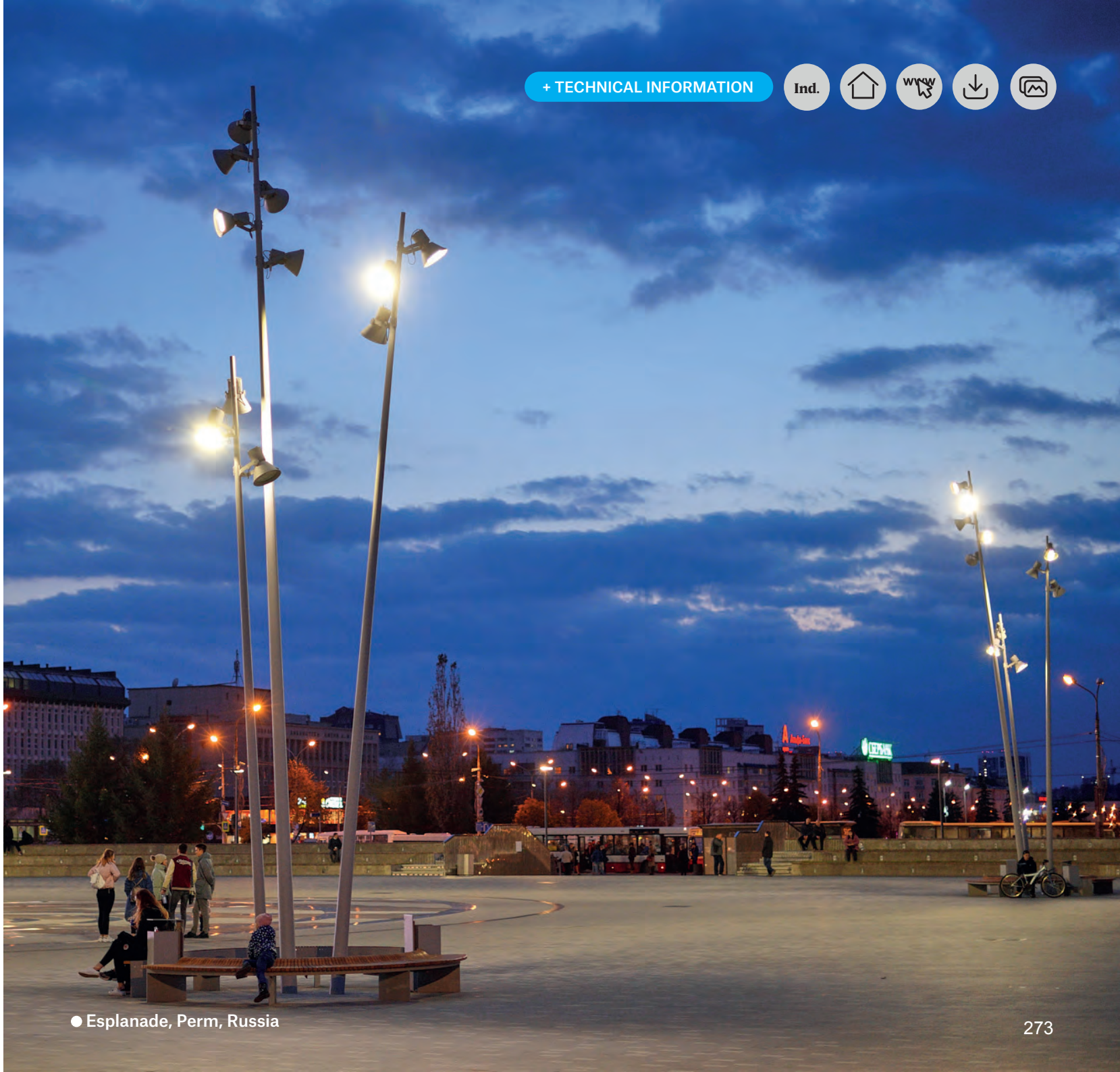



INDOOR

A
 ● AMBIENT

D
 ● DOMO 220

F
 ● FIL 35
 ● FIL 45
 ● FIL 50
 ● FIL 70
 ● FIL 120
 ● FINE LED STRIP

G
 ● GENERAL ACC.

H
 ● HANCE 48V
 ● HANCE DOWN.
 ● HANCE SPOT.
 ● HEALTH & WELL
 ● HERMETICA

I
 ● IMAG

K
 ● KOMBIC DOWN.
 ● KOMBIC SUR.

L
 ● LAMPTUB 60
 ● LAMPTUB 80

M
 ● MODULAR CUSTOM
 ● MOODY
 ● MUN DARK
 ● MUN LIGHT

O
 ● OCULT DOWN.
 ● OCULT SYSTEM

P
 ● PLAT
 ● PUZZLE

Q
 ● QUIET

R
 ● RING

S
 ● STORMBELL
 ● STORMBELL 80

T
 ● TRACK
 ● TRANSIT

OUTDOOR

B
 ● B-SIDE
 ● BAULINE
 ● BAZZ

D
 ● DUIT

F
 ● FLUT

G
 ● GAP
 ● GENERAL ACC.

L
 ● LUP

M
 ● MUN DARK IP65

N
 ● NIU

O
 ● OWL

P
 ● PUCK

S
 ● SETI
 ● SHOT

T
 ● TRACE IP65

U
 ● URBAN 100

X
 ● XTREMA

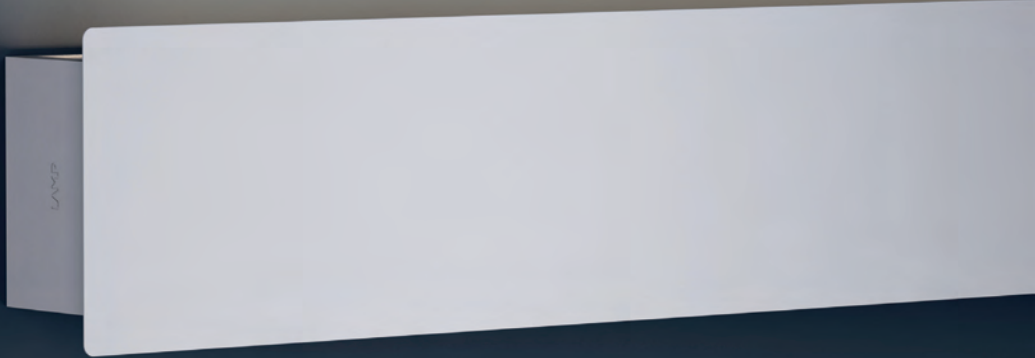

Ambient

Ambient

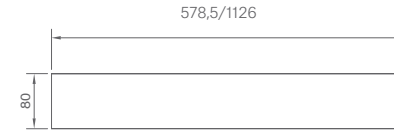
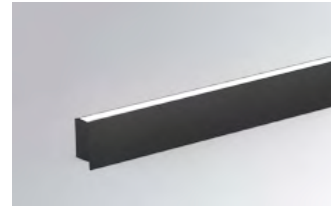
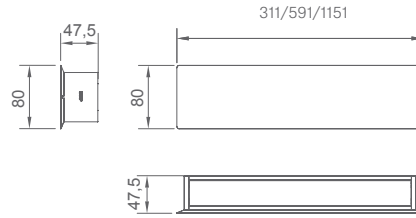
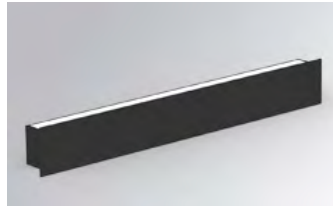

*Luminaire individual + front accessory image.

*Luminaire continuous + front accessory image.

AMBIENT LINEAL (INDIVIDUAL)

Family	Format	Installation	Lm LED/m	Optics	CRI	K	Gear	Finishes	
AM2	030 300mm 060 600mm 120 1200mm	DR Individual directo	25 2500lm/m	OP Opal	8 80	30 3000K 40 4000K	N ON/OFF D DALI	B Black 02 W White 02	
				AS Asym				TW Tunable White	B Black 02 W White 02
				GZ Grazer					
	030 300mm 060 600mm 120 1200mm	DI Individual dir / ind		OO Opal-Opal	8 80	30 3000K 40 4000K	N ON/OFF D DALI	B Black 02 W White 02	
				OA Opal-Asym				TW Tunable White	B Black 02 W White 02
				OO Opal-Opal					
	120 1200mm	DS Ind dir/ind doble encendido		OO Opal-Opal	8 80	30 3000K 40 4000K	N ON/OFF D DALI	B Black 02 W White 02	
				OA Opal-Asym				TW Tunable White	B Black 02 W White 02
				OG Opal-Grazer AG Asym-Grazer					
	120 1200mm				OO Opal-Opal	8 80	30 3000K 40 4000K	N ON/OFF D DALI	B Black 02 W White 02
					OO Opal-Opal				8 80

AMBIENT LINEAL SYSTEM (CONTINUOUS)

Family	Format	Installation	Lm LED/m	Optics	CRI	K	Gear	Finishes
AM2	060 600mm 120 1200mm	DR Direct	MO 2500lm/m	OP Opal	8 80	30 3000K 40 4000K	N ON/OFF D DALI	B Black 02 W White 02
				AS Asym GZ Grazer				
	060 600mm 120 1200mm	DI Dir / Ind	MO 2500lm/m	OO Opal-Opal	8 80	30 3000K 40 4000K	N ON/OFF D DALI	B Black 02 W White 02
				OA Opal-Asym				OO Opal-Opal

AM2 060 DI MO OA 8 30 D B



***FRONT ACCESSORY NOT INCLUDED.**
P. 279



OP

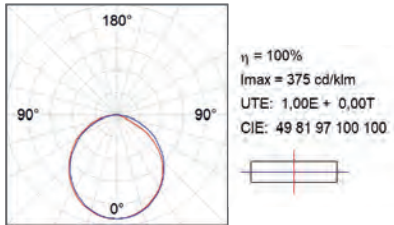

OO

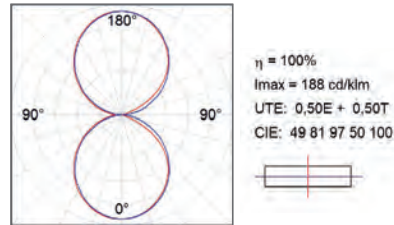

AS

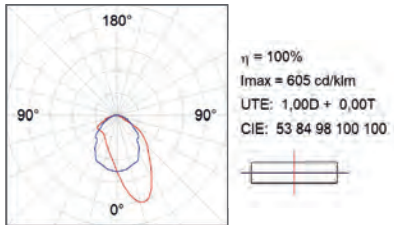

OA

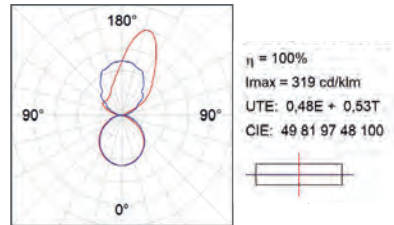

GZ

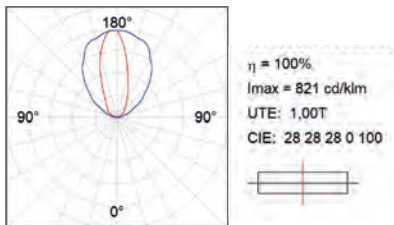

OG

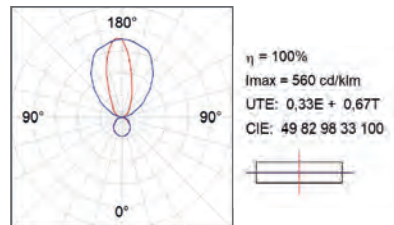

AG

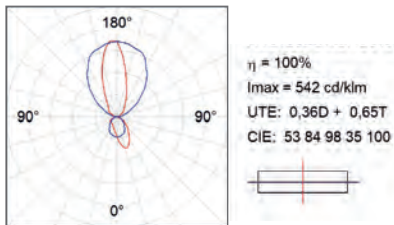

AMBIENT DIRECT LINEAR APPLICATION

	K	CRI	300mm		600mm		1200mm	
			W	lm Output	W	lm Output	W	lm Output
OP	3000	80	5,4	495	9,8	990	18,6	1980
	4000	80	5,4	519	9,8	1039	18,6	2077
	TW	80			8,7	991	16,3	1982
AS	3000	80	5,4	544	9,8	1088	18,6	2176
	4000	80	5,4	571	9,8	1141	18,6	2283
GZ	3000	80	8,3	995	15,8	1990	30,5	3980
	4000	80	8,3	1055	15,8	2109	30,5	4219

AMBIENT LINEAR SYSTEM

	K	CRI	600mm		1200mm	
			W	lm Output	W	lm Output
OP	3000	80	9,8	990	18,6	1980
	4000	80	9,8	1039	18,6	2077
	TW	80	8,7	991	16,3	1982
AS	3000	80	9,8	1088	18,6	2176
	4000	80	9,8	1414	18,6	2283
GZ	3000	80	15,4	1990	30,5	3980
	4000	80	15,4	2109	30,5	4219

AMBIENT DIRECT/INDIRECT LINEAR APPLICATION

	K	CRI	300mm		600mm		1200mm	
			W	lm Output	W	lm Output	W	lm Output
OP/OP	3000	80	9,8	990	18,6	2078	34,5	3960
	4000	80	9,8	1039	18,6	2180	34,5	4154
	TW	80			16,3	1982	31,9	3964
OP/AS	3000	80	9,8	1088	18,6	2078	34,5	4156
	4000	80	9,8	1414	18,6	2180	34,5	4360
AS/GZ	3000	80					49,1	6156
	4000	80					49,1	6458
OP/GZ	3000	80					49,1	6156
	4000	80					49,1	6458

AMBIENT DIRECT/INDIRECT SYSTEM

	K	CRI	600mm		1200mm	
			W	lm Output	W	lm Output
OP/OP	3000	80	18,6	2078	34,8	3960
	4000	80	18,6	2077	34,8	4154
	TW	80	16,3	1982	31,9	3964
OP/AS	3000	80	18,6	2078	34,8	4156
	4000	80	18,6	2180	34,8	4360
AS/GZ	3000	80			49,1	6156
	4000	80			49,1	6458
OP/GZ	3000	80			49,1	5960
	4000	80			49,1	6253



ACCESSORIES

Front accessory for linear wall light (INDIVIDUAL)

Ref.	mm	Color
AM2ACIN030B	300	● Black
AM2ACIN030W	300	○ White
AM2ACIN060B	600	● Black
AM2ACIN060W	600	○ White
AM2ACIN120B	1200	● Black
AM2ACIN120W	1200	○ White
AM2ACIN030ABK	300	● Anodised Black
AM2ACIN030ABL	300	● Anodised Blue
AM2ACIN030ABZ	300	● Anodised Bronze
AM2ACIN030ACH	300	● Anodised Champagne
AM2ACIN030AGD	300	● Anodised Gold
AM2ACIN030ARW	300	● Anosided Raw
AM2ACIN060ABK	600	● Anodised Black
AM2ACIN060ABL	600	● Anodised Blue
AM2ACIN060ABZ	600	● Anodised Bronze
AM2ACIN060ACH	600	● Anodised Champagne
AM2ACIN060AGD	600	● Anodised Gold
AM2ACIN060ARW	600	● Anosided Raw
AM2ACIN120ABK	1200	● Anodised Black
AM2ACIN120ABL	1200	● Anodised Blue
AM2ACIN120ABZ	1200	● Anodised Bronze
AM2ACIN120ACH	1200	● Anodised Champagne
AM2ACIN120AGD	1200	● Anodised Gold
AM2ACIN120ARW	1200	● Anosided Raw

Intermediate front fitting for LINEAR SYSTEM (CONTINUOUS)

Ref.	mm	Color
AM2AC120B	1200	● Black
AM2AC120W	1200	○ White
AM2AC120ABK	1200	● Anodised Black
AM2AC120ABL	1200	● Anodised Blue
AM2AC120ABZ	1200	● Anodised Bronze
AM2AC120ACH	1200	● Anodised Champagne
AM2AC120AGD	1200	● Anodised Gold
AM2AC120ARW	1200	● Anosided Raw

Accesorio frontal END

Ref.	mm	Color
AM2AC060B	600	● Black
AM2AC060W	600	○ White
AM2AC060ABK	600	● Anodised Black
AM2AC060ABL	600	● Anodised Blue
AM2AC060ABZ	600	● Anodised Bronze
AM2AC060ACH	600	● Anodised Champagne
AM2AC060AGD	600	● Anodised Gold
AM2AC060ARW	600	● Anosided Raw

End cover for LINEAR SYSTEM (CONTINUOUS)

Ref.	Color
AM2ACECB	○
AM2ACECW	●



***FRONT ACCESSORY NOT INCLUDED.**

Anodised finishes: only available for front fitting (white or black luminaire).



Domo 220



Domo 220 Symmetric

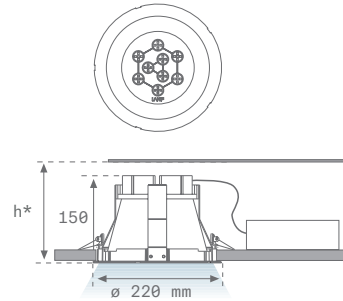

* See height (h) in the instruction sheet.

Domo 220 Asymmetric

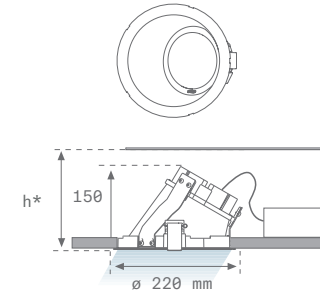

* See height (h) in the instruction sheet.

DOMO 220

Family	Format	Lm LED	Optic	CRI	K	Gear	Finishes
D02	RD Round	20 2000lm	SY Symmetric	8 80	30 3000 K	N ON/OFF	W White 02
		30 3000lm			40 4000 K	D DALI	
		40 4000lm	AS Asymmetric	8 80	30 3000 K		
D02	RD	20	SY	8	30	N	W

TECHNICAL CHARACTERISTICS

Optics

SY

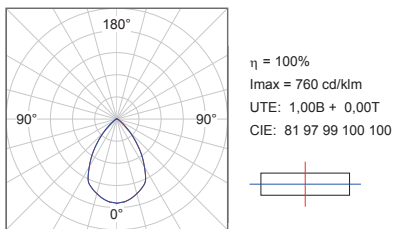

AS

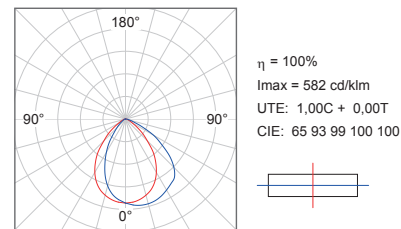

Light output and power

DOMO 220

	K	CRI	2000lm		3000lm		4000lm	
			W	lm Output	W	lm Output	W	lm Output
SY	3000	80	23	2054	32	2825	40,9	3665
	4000	80	23	2136	32	2938	40,9	3812
AS	3000	80	23	1534	32	2110	40,9	2737





ACCESSORIES

Transparent diffuser



Ref.

[DITRRD240W](#)
[DITRRD240B](#)
[DITRRD240G](#)

Color



Pict.



Opal diffuser



Ref.

[DIOPRD240W](#)
[DIOPRD240G](#)

Color



Pict.



Decorative ring



Ref.









[RIRD240W](#)
[RIRD240B](#)
[RIRD240G](#)

Color



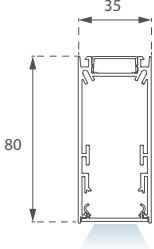
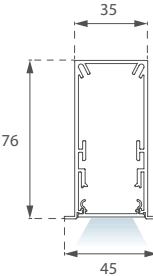
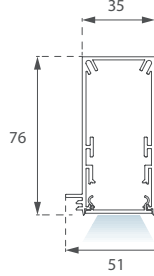
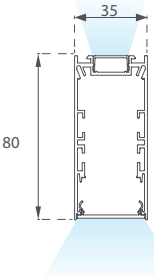

Fil 35

Models	OPAL		OPAL COMFORT		TECH		DIRECT / INDIRECT		
									
Dimensions	SURFACE		RECESSED		TRIMLESS		DIRECT / INDIRECT		
									
Lm LED	1200 lm	1470 lm	1600 lm	2000 lm	2400 lm	2650 lm	2800 lm	3200 lm	
Lenghts	840 mm	1120 mm	1400 mm	1680 mm	1960 mm	2240mm			
CRI	80 / 90								
Beam angle	 Opal		 Opal Comfort		 Tech		 Dir / Ind		
Color temp.	3000 / 4000 K								
Gear	ON/OFF - DALI								
Power	8 W	11 W	12 W	14 W	16 W	18 W	19 W	22 W	32 W
Acc. Finishes	● Black 02		○ White 02		● Grey 01				

Fil 35
Opal



Fil 35
Opal Comfort



Fil 35
Tech

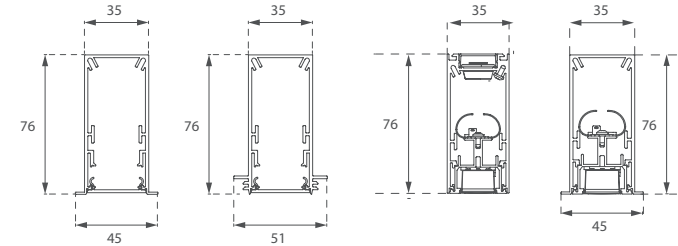

FIL 35

Family	Installation	Format	Lm LED/m	Optic	CRI	K	Gear	Finishes						
F31	SF Surface	084 840mm	LO 1470lm MO 2650lm	OP Opal	8 80	30 3000 K 40 4000 K	N ON/OFF D DALI	B Black 02 W White 02 G Grey 01						
		112 1120mm												
		140 1400mm												
		168 1680mm												
		196 1960mm												
		224 2240mm												
	RE Recessed	084 840mm	LO 1470lm MO 2650lm	OC Opal Comfort	9 90	30 3000 K 40 4000 K	N ON/OFF D DALI	B Black 02 W White 02						
		112 1120mm												
		140 1400mm												
		168 1680mm												
		084 840mm							MO 2620lm	TE Tech	9 90	30 3000 K 40 4000 K	N ON/OFF D DALI	B Black 02 W White 02
		112 1120mm												
168 1680mm														
TR Trimless		084 840mm	LO 1470lm MO 2650lm	OP Opal	8 80	30 3000 K 40 4000 K	N ON/OFF D DALI	W White 02						
		112 1120mm												
		140 1400mm												
		168 1680mm												
		196 1960mm												
		224 2240mm												
		084 840mm	LO 1470lm MO 2650lm	OC Opal Comfort	9 90	30 3000 K 40 4000 K	N ON/OFF D DALI	W White 02						
		112 1120mm												
		140 1400mm												
		168 1680mm												

F31 SF 084 LO OP 8 30 N B



























TECHNICAL CHARACTERISTICS

Optics

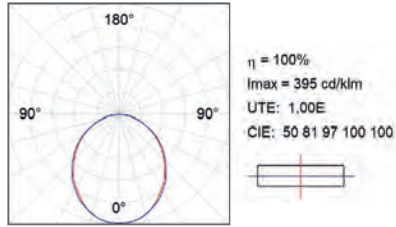
OP

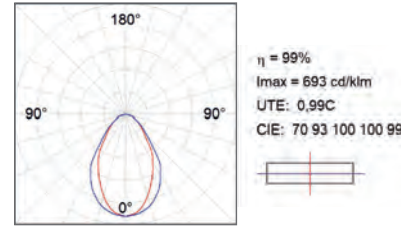

OC



TE

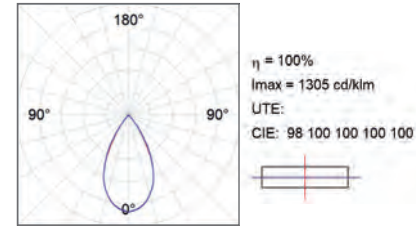

Light output and power

FIL 35

				1760mm		2435mm		3045mm		3674mm		4120mm		4450mm	
		K	CRI	W	lm Output	W	lm Output	W	lm Output	W	lm Output	W	lm Output	W	lm Output
LO	OP	3000	80	8,8	866	12,1	1155	14,4	1444	17,1	1733	18,9	2022	21,7	2310
		4000	80	8,8	912	12,1	1216	14	1520	17,1	1824	18,9	2128	21	2432
	OC	3000	80	8,8	801	12,1	1068	14,4	1334	17,1	1601	18,9	1868	21,7	2135
		4000	80	8,8	834	12,1	1112	14	1390	17,1	1668	18,9	1946	22	2224
MO	OP	3000	80	13,5	1281	18	1708	21,2	2135	25,2	2562	28	2989	36	3416
		4000	80	13,5	1329	18	1772	21,2	2215	25,2	2658	28	3101	36	3544
	OC	3000	80	13,5	1179	18	1571	21,2	1964	25,2	2357	-	-	-	-
		4000	80	13,5	1223	18	1630	21,2	2038	25,2	2445	-	-	-	-
	TE	3000	90	13,7	1260	17,8	1680	-	-	22	2520	-	-	-	-
		4000	90	13,7	1320	17,8	1760	-	-	22	2640	-	-	-	-

Fil 35
Direct/Indirect

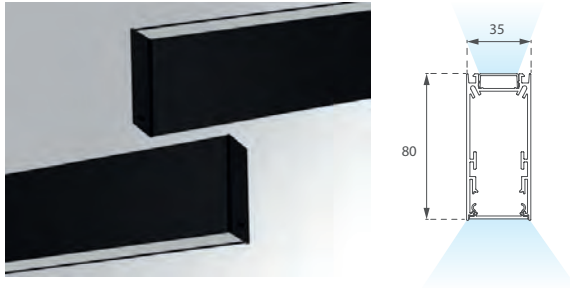

FIL 35 DIRECT-INDIRECT

Family	Installation	Format	Lm LED/m	Optic	CRI	K	Gear	Finishes
F31	SF Surface	084 840mm	LO 1470lm	IO Dir./Ind Opal	8 80	30 3000 K	N ON/OFF	B Black 02
		112 1120mm	MO 2650lm					
		140 1400mm						
		168 1680mm						
		196 1960mm						
		224 2240mm						
		084 840mm	LO 1470lm	IC Dir/Ind Opal Comfort	8 80	30 3000 K	N ON/OFF	B Black 02
		112 1120mm	MO 2650lm					
		140 1400mm						
		168 1680mm						
F31	SF	084	LO	IO	8	30	N	B



Fil 35
Corner

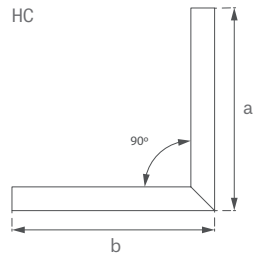

HC	a (mm)	b (mm)
SF	303	303
RE	313	313
TR	311	311

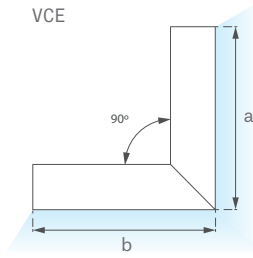

VCE	a (mm)	b (mm)
SF	305	305
RE	305	305
TR	305	305

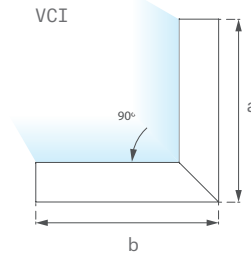

VCI	a (mm)	b (mm)
SF	354	654
RE	350	350
TR	350	350

FIL 35 CORNER

Family	Installation	Format	Lm LED/m	Optic	CRI	K	Gear	Finishes
F31	SF Surface RE Recessed	HC Horizontal Corner	LO 1470lm	OP Opal OC Opal Comfort	8 80	30 3000 K 40 4000 K	N ON/OFF D DALI	B Black 02
		VCI Vertical Corner Interior VCE Vertical Corner Exterior	LO 1470lm	OP Opal				W White 02 G Grey 01
	TR Trimless	HC Horizontal Corner	LO 1470lm	OP Opal OC Opal Comfort	8 80	30 3000 K 40 4000 K	N ON/OFF D DALI	W White 02
		VCI Vertical Corner Interior VCE Vertical Corner Exterior	LO 1470lm	OP Opal				
EX: F31	SF	HC	LO	OP	8	30	N	B





TECHNICAL CHARACTERISTICS

Optics

IO

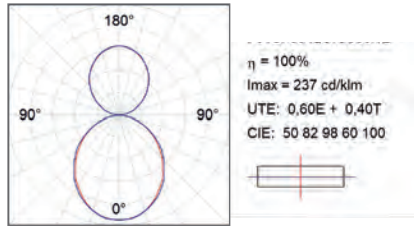

IC

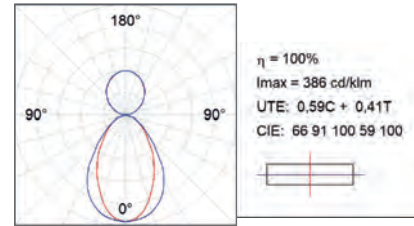

Light output and power

FIL 35 DIRECT-INDIRECT

				840mm		1120mm		1400mm		1680mm		1960mm		2240mm			
		K	CRI	W	lm Output	W	lm Output	W	lm Output	W	lm Output	W	lm Output	W	lm Output		
LO	IO	IND	3000	80	7,2	717	7	796	9	995	11	1193	13	1392	14	1591	
		DIR			9,6	956	11	1216	14	1520	16	1824	19	2128	22	2432	
	IC	IND	3000	80	7,2	679	7	796	9	995	11	1193	-	-	-	-	
		DIR			9,6	905	11	1112	14	1390	16	1668	-	-	-	-	
	MO	IO	IND	3000	80	6	597	7	796	12	995	16	1342	17,8	1938	15	-
			DIR			12	1287	16	1708	18	2135	24,4	2046	27,5	2989	32	-
MO	IC	IND	4000	80	6	617	7	823	12	1028	14	1234	17	1440	15	-	
		DIR			12	1329	16	1772	18	2215	22	2658	25	3101	32	-	
	IC	IND	3000	80	6	597	7	795	12	995	14	1193	-	-	-	-	
		DIR			12	1179	16	1571	18	1964	22	2357	-	-	-	-	
MO	IC	IND	4000	80	6	617	7	823	12	1028	14	1234	-	-	-	-	
		DIR			12	1223	16	1630	18	2038	22	2445	-	-	-	-	



ACCESSORIES

End cover surface

Ref.	Color
F3SUECB	●
F3SUECW	○
F3SUECG	●

Surface Profile max. 3m

Ref.	Color
F3PRSUX/MMB	●
F3PRSUX/MMW	○
F3PRSUX/MMG	●

End cover recessed

Ref.	Color
F3REECB	●
F3REECW	○
F3REECG	●

Recessed Profile max. 3m

Ref.	Color
F3PRREX/MMB	●
F3PRREX/MMW	○
F3PRREX/MMG	●

End cover trimless

Ref.	Color
F3TRECW	○

Trimless Profile max. 3m

Ref.	Color
F3PRTRX/MMW	○

Cover max. 3m

Ref.	Color
F3COX/MMB	●
F3COX/MMW	○
F3COX/MMG	●

Opal polycarbonate diffuser max. 3m

Ref.	Color
F3DIX/MMOP	○

ACCESSORIES

2 Fixings for joint (1 unit/ref.)



Ref.

- F3J0** Surface
- F3REJ0** Recessed/Trimless

Short ceiling bracket joint 2 unit/ref.



Ref.

F3FX15G

Wall bracket 2 unit/ref.



Ref.

- F3FX50G**
- F3FX50B**
- F3FX50W**

Color

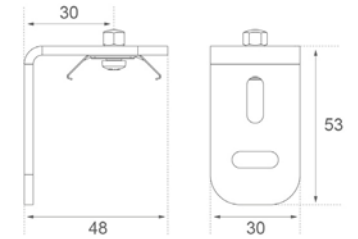



ACCESSORIES

Recessed Basic Ceiling rose

Ref.	Color	h(mm)
SUCAREBA1500NB	●	1500
SUCAREBA1500NW	○	1500
SUCAREBA3000NB	●	3000
SUCAREBA3000NW	○	3000
DALI		
SUCAREBA1500DB	●	1500
SUCAREBA1500DW	○	1500
SUCAREBA3000DB	●	3000
SUCAREBA3000DW	○	3000

Recessed Deco Ceiling rose

Ref.	Color	h(mm)
SUCAREDE1500NB	●	1500
SUCAREDE1500NW	○	1500
SUCAREDE3000NB	●	3000
SUCAREDE3000NW	○	3000
DALI		
SUCAREDE1500DB	●	1500
SUCAREDE1500DW	○	1500
SUCAREDE3000DB	●	3000
SUCAREDE3000DW	○	3000

Height-adjustable steel cable

Ref.	Color	h(mm)
F42SUWIDE1500G	●	1500
F42SUWIDE3000G	●	3000
Quick anchorage		

Surface Basic Ceiling rose

Ref.	Color	h(mm)
SUCASFBA1500NB	●	1500
SUCASFBA1500NW	○	1500
SUCASFBA3000NB	●	3000
SUCASFBA3000NW	○	3000
DALI		
SUCASFBA1500DB	●	1500
SUCASFBA1500DW	○	1500
SUCASFBA3000DB	●	3000
SUCASFBA3000DW	○	3000

Surface Deco Ceiling rose

Ref.	Color	h(mm)
SUCASFDE1500NB	●	1500
SUCASFDE1500NW	○	1500
SUCASFDE3000NB	●	3000
SUCASFDE3000NW	○	3000
DALI		
SUCASFDE1500DB	●	1500
SUCASFDE1500DW	○	1500
SUCASFDE3000DB	●	3000
SUCASFDE3000DW	○	3000

Height-adjustable steel cable for electromechanical connection (3 or 5xØ1,5)

Ref.	Color	h(mm)
F42SUCAEMF1500NB	●	1500
F42SUCAEMF1500NW	○	1500
F42SUCAEMF3000NB	●	3000
F42SUCAEMF3000NW	○	3000
DALI		
F42SUCAEMF1500DB	●	1500
F42SUCAEMF1500DW	○	1500
F42SUCAEMF3000DB	●	3000
F42SUCAEMF3000DW	○	3000
Quick anchorage		



Fil 45



Fil 45
Opal

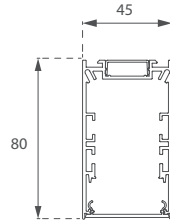

Fil 45
Opal Comfort

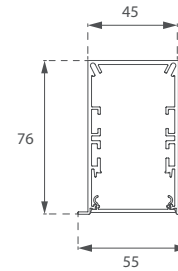

Fil 45
Tech

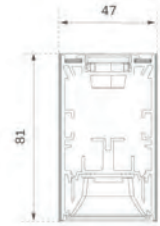

FIL 45 DIRECT

Family	Installation	Formats	Lm LED/m	Optic	CRI	K	Gear	Finishes
F41	SF Surface RE Recessed	084 840mm	MO 2320lm	OP Opal	8 80	30 3000 K	N ON/OFF D DALI	B Black 02 W White 02 G Grey 01
		112 1120mm	HO 4288lm			40 4000 K		
		140 1400mm						
		168 1680mm						
			196 1960mm					
			224 2240mm					
			084 840mm	MO 2320lm	PR Opal Comfort	8 80		B Black 02 W White 02
			112 1120mm			9 90		
			140 1400mm					
			168 1680mm					
			224 2240mm					
			112 1120mm	MO 2320lm	OP Opal	8 80	TW Tunable White	D DALI
		168 1680mm		PR Opal Comfort				
F41	SF	084	MO	OP	8	30	N	B

FIL 45 TECH G2

Family	Installation	Formats	Lm LED/m	Optic	CRI	K	Gear	Finishes
F42	SF Surface RE Recessed	084 840mm	MO 2320lm	TE Tech	9 90	30 3000 K	N ON/OFF D DALI	B Black 02 W White 02 G Grey 01
		112 1120mm		TA Tech Asym		40 4000 K		
		140 1400mm						
		168 1680mm						
		196 1960mm						
		224 2240mm						
F41	SF	112	MO	TE	9	30	N	B

WB FIL 45 DIRECT WELLBEING

Family	Installation	Formats	Lm LED/m	Optic	K	Gear	Finishes
F41	SF Surface RE Recessed	112 1120mm	MO 2320lm	PR Opal Comfort	WB3 3000 WB	N ON/OFF D DALI	B Black 02 W White 02 G Grey 01
		168 1680mm			WB4 4000 WB		
					WB T Tunable White WB		
F41	SF	112	MO	PR	WB3	N	B





TECHNICAL CHARACTERISTICS

Optics

OPAL

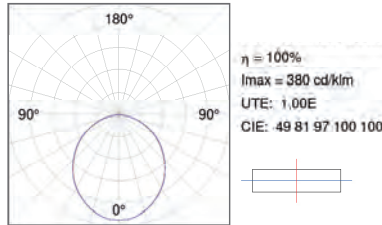

OPAL COMFORT

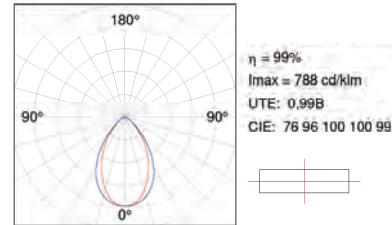

TECH TE

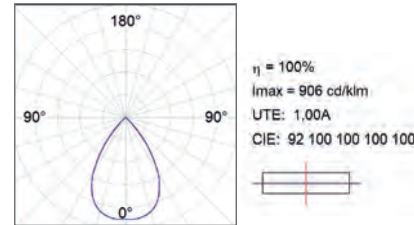

TECH TA

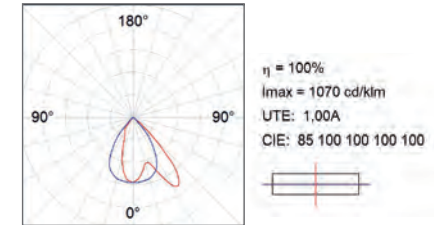

Light output and power

FIL 45 DIRECT

				840mm		1120mm		1400mm		1680mm		1960mm		2240mm	
		K	CRI	W	lm Output	W	lm Output	W	lm Output	W	lm Output	W	lm Output	W	lm Output
MO	OP	3000	80	13,3	1292	17,5	1722	20,3	2153	24,7	2583	27,8	3014	37	3444
		4000	80	13,3	1354	17,5	1805	20,3	2257	24,7	2708	27,8	3160	37	3611
	PR	3000	80	15,6	1441	20,9	1922	25,9	2401	31	2881	-	-	-	-
		4000	80	15,6	1512	20,9	2017	25,9	2521	31	3026	-	-	-	-
	3000	90	15,6	1210	20,9	1614	25,9	2017	31	2420	-	-	-	-	
	4000	90	15,6	1270	20,9	1694	25,9	2117	31	2542	-	-	-	-	

FIL 45 TECH G2

				840mm		1120mm		1400mm		1680mm		1960mm		2240mm	
		K	CRI	W	lm Output	W	lm Output	W	lm Output	W	lm Output	W	lm Output	W	lm Output
MO	TE	3000	80	12,2	1310	15,5	1746	19	2183	22,3	2620	26	3056	29,7	3493
		4000	80	12,2	1371	15,5	1828	19	2285	22,3	2742	26	3200	29,7	3657
	TA	3000	90	12,2	1072	16,3	1429	19,4	1786	22,8	2143	26	2500	29,7	2858
		4000	90	12,2	1122	16,3	1496	19,4	1870	22,8	2244	26	2618	29,7	2992

FIL 45 DIRECT WELLBEING

				1120mm		1680mm	
		K	CRI	W	lm Output	W	lm Output
MO	PR	3000	98	20,6	1610	42,4	2338
		4000	98	20,	1729	42,4	2817



Fil 45
Direct/Indirect

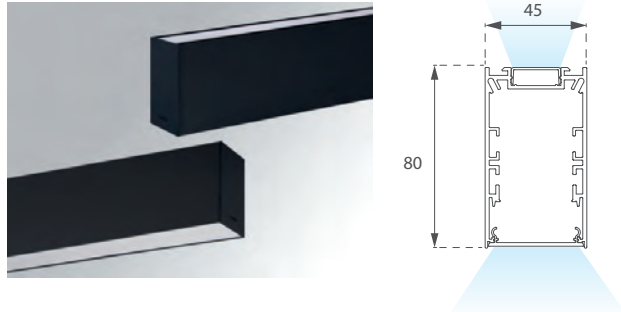

FIL 45 DIRECT-INDIRECT

Family	Installation	Formats	Lm LED/m	Optic	CRI	K	Gear	Finishes
F41	SF Surface	084 840mm	MO 2320lm	IO Dir./Ind Opal	8 80	30 3000 K 40 4000 K	N ON/OFF D DALI	B Black 02 W White 02 G Grey 01
		112 1120mm						
		140 1400mm						
		168 1680mm						
		196 1960mm						
		224 2240mm						
		084 840mm	MO 2320lm	IP Dir./Ind Opal Comfort	8 80			
		112 1120mm						
		140 1400mm						
		168 1680mm						
F41	SF	084	MO	IO	8	30	N	B

FIL 45 DIRECT-INDIRECT TW

Family	Installation	Formats	Lm LED/m	Optic	CRI	K	Gear	Finishes
F41	SF Surface	112 1120mm	MO 2320lm	IO Dir./Ind Opal IP Dir./Ind Opal Comfort	8 80	TW Tunable White	D DALI	B Black 02 W White 02 G Grey 01
		168 1680mm						
		224 2240mm						
F41	SF	112	MO	IO	8	TW	D	B

FIL 45 DIRECT-INDIRECT TW WB

Family	Installation	Formats	Lm LED/m	Optic	CRI	Gear	Finishes
F41	SF Surface	112 1120mm	MO 2320lm	IP Dir./Ind Opal Comfort	WB Tunable White WB	D DALI	B Black 02 W White 02
		168 1680mm					
		224 2240mm					
F41	SF	112	MO	IP	WB	D	B





TECHNICAL CHARACTERISTICS

Optics

IO

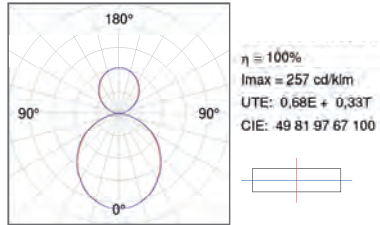

IP

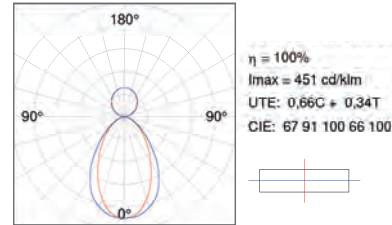

Light output and power

FIL 45 DIRECT/INDIRECT

				840mm		1120mm		1400mm		1680mm		1960mm		2240mm		
		K	CRI	W	lm Output	W	lm Output	W	lm Output	W	lm Output	W	lm Output	W	lm Output	
MO	IO	IND	3000	80	7,9	621	8,7	827	10,7	1034	12,9	1240	15,1	1511	16,45	1654
		DIR	3000	80	14,1	1292	19,6	1723	22,6	2154	27,2	2584	31,4	3146	36,45	3445
		IND	4000	80	7,9	642	8,7	856	10,7	1069	12,9	1284	15,1	1498	16,45	1711
		DIR	4000	80	14,1	1354	19,6	1805	22,6	2257	27,2	2708	31,4	3159	36,45	3611
	IP	IND	3000	80	7,9	606	8,7	807	10,7	1426	12,9	1898	-	-	-	-
		DIR	3000	80	14,1	1487	19,6	1983	22,6	2062	27,2	2288	-	-	-	-
		IND	3000	90	7,9	606	8,7	807	10,7	1426	12,9	2360	-	-	-	-
		DIR	3000	90	14,1	1249	19,6	1665	22,6	1732	27,2	2011	-	-	-	-
		IND	4000	80	7,9	784	8,7	1256	10,7	1785	12,9	2360	-	-	-	-
		DIR	4000	80	14,1	1592	19,6	1912	22,6	2174	27,2	2393	-	-	-	-
		IND	4000	90	7,9	784	8,7	1256	10,7	1785	12,9	2360	-	-	-	-
		DIR	4000	90	14,1	1337	19,6	1606	22,6	1826	27,2	2011	-	-	-	-

FIL 45 DIRECT/INDIRECT TW

				1120mm		1680mm		2240mm		
		K	CRI	W	lm Output	W	lm Output	W	lm Output	
MO	IO	IND	TW	80	30,6	2935	47,2	4403	61,2	5870
		DIR	TW	80	13	1044	18,6	1670	27,12	2088
	IP	IND	TW	80	30,6	2617	47,2	3917	61,2	5233
		DIR	TW	80	13	1044	18,6	1670	27,12	2088

FIL 45 DIRECT/INDIRECT TW WB

				1120mm		1680mm		2240mm		
		K	CRI	W	lm Output	W	lm Output	W	lm Output	
MO	IP	IND	WBT	90	34,3	1612	47,1	2409	68,6	3224
		DIR	WBT	90	13	1044	18,6	1670	27,12	2088



Fil 45
Corner

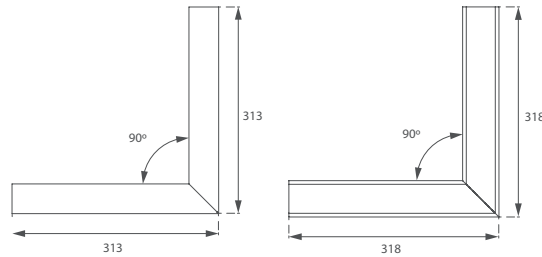

Fil 45
Curve

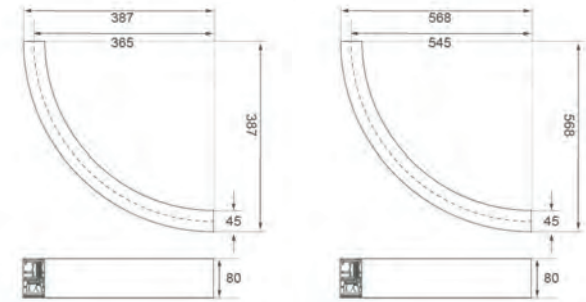

FIL 45 CORNER

Family	Installation	Formats	Lm LED/m	Optic	CRI	K	Gear	Finishes
F41	SF Surface	CR Corner	MO 2320lm	OP Opal	8 80	30 3000 K 40 4000 K	N ON/OFF D DALI	B Black 02 W White 02 G Grey 01
	RE Recessed			PR Opal Comfort				
F41	SF	CR	MO	OP	8	30	N	B

FIL 45 CURVE

Family	Installation	Formats	Lm LED/m	Optic	CRI	K	Gear	Finishes
F41	SF Surface	CC3 Corner Curvo R365mm	MO 2320lm	OP Opal	8 80 9 90	30 3000 K 40 4000 K	N ON/OFF D DALI	B Black 02 W White 02 G Grey 01
		CC5 Corner Curvo R545mm		PR Opal Comfort				
F41	SF	CC3	MO	OP	8	30	N	B





TECHNICAL CHARACTERISTICS

Light output and power

FIL 45 CORNER

		90°			
		K	CRI	W	lm Output
MO	OP	3000	80	9,6	861
		4000	80	9,6	903
PR		3000	90	10,9	960
		4000	90	10,9	1009

FIL 45 CURVE

		R365mm				R545mm	
		K	CRI	W	lm Output	W	lm Output
MO	OP	3000	80	9,3	861	13,7	1292
		4000	80	9,3	903	13,7	1355
		3000	90	9,3	739	13,7	1109
		4000	90	9,3	776	13,7	1163
PR		3000	80	9,3	960	13,7	1440
		4000	80	9,3	1009	13,7	1514
		3000	90	9,3	824	13,7	1236
		4000	90	9,3	867	13,7	1300



ACCESSORIES

End cover Surface



Ref.

F4SUECB
F4SUECW
F4SUECG

End cover Fil Curve

Ref.

F4SFCCECB
F4SFCCECG
F4SFCCECW

End cover Recessed

Ref.

F4REECB
F4REECW
F4REECG

Color



Surface Profile max. 3m



Ref.

F4PRSUX/MMB
F4PRSUX/MMW
F4PRSUX/MMG

Color



Recessed Profile max. 3m



Ref.

F4PRREX/MMB
F4PRREX/MMW
F4PRREX/MMG

Color



Cover max. 3m



Ref.

F4COX/MMB
F4COX/MMW
F4COX/MMG

Color



Opal polycarbonate diffuser max. 3m



Ref.

F4DIX/MMOP

Color



Emergency



Ref.

F41EMG3HDWB
F41EMG3HDWW
F41EMG3HDWG

Color



Light Sensor



Ref.

F4LIGHTSNDB
F4LIGHTSNW
F4LIGHTSNDG

Color





ACCESSORIES

Height-adjustable steel cable

	Ref.	Color	h(mm)
	F42SUWIDE1500G	●	1500
	F42SUWIDE3000G	●	3000

Quick anchorage

Height-adjustable steel cable for electromechanical connection (3 or 5xØ1,5)

	Ref.	Color	h(mm)	
	F42SUCAEMF1500NB	●	1500	
	F42SUCAEMF1500NW	○	1500	
	F42SUCAEMF3000NB	●	3000	
	F42SUCAEMF3000NW	○	3000	
	DALI			
	F42SUCAEMF1500DB	●	1500	
	F42SUCAEMF1500DW	○	1500	
	F42SUCAEMF3000DB	●	3000	
F42SUCAEMF3000DW	○	3000		

Quick anchorage

Height-adjustable steel cable for connection Fil Curve

	Ref.	Color	h(mm)
	F42SUCCWIDE1500G	●	1500
	F42SUCCWIDE3000G	●	3000

Quick anchorage

Fixings for joint 1 unit/ref.

	Ref.	Color
	F42J0	Surface Recessed

Wall bracket 2 unit/ref.

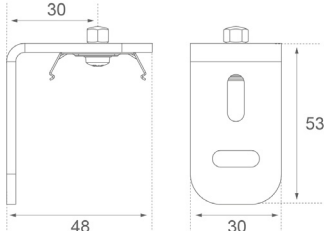
	Ref.	Color	
	F4FX50G	●	
	F4FX50B	●	
	F4FX50W	○	

Short ceiling bracket joint 2 unit/ref.

	Ref.
	F4FX15G



ACCESSORIES

Recessed Basic Ceiling rose

	Ref.	Color	h(mm)	
	SUCAREBA1500NB	●	1500	
	SUCAREBA1500NW	○	1500	
	SUCAREBA3000NB	●	3000	
	SUCAREBA3000NW	○	3000	
	DALI			
	SUCAREBA1500DB	●	1500	
	SUCAREBA1500DW	○	1500	
	SUCAREBA3000DB	●	3000	
SUCAREBA3000DW	○	3000		

Surface Basic Ceiling rose

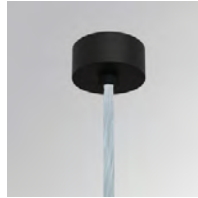
	Ref.	Color	h(mm)	
	SUCASFBA1500NB	●	1500	
	SUCASFBA1500NW	○	1500	
	SUCASFBA3000NB	●	3000	
	SUCASFBA3000NW	○	3000	
	DALI			
	SUCASFBA1500DB	●	1500	
	SUCASFBA1500DW	○	1500	
	SUCASFBA3000DB	●	3000	
SUCASFBA3000DW	○	3000		

Recessed Deco Ceiling rose

	Ref.	Color	h(mm)	
	SUCAREDE1500NB	●	1500	
	SUCAREDE1500NW	○	1500	
	SUCAREDE3000NB	●	3000	
	SUCAREDE3000NW	○	3000	
	DALI			
	SUCAREDE1500DB	●	1500	
	SUCAREDE1500DW	○	1500	
	SUCAREDE3000DB	●	3000	
SUCAREDE3000DW	○	3000		

Surface Deco Ceiling rose

	Ref.	Color	h(mm)	
	SUCASFDE1500NB	●	1500	
	SUCASFDE1500NW	○	1500	
	SUCASFDE3000NB	●	3000	
	SUCASFDE3000NW	○	3000	
	DALI			
	SUCASFDE1500DB	●	1500	
	SUCASFDE1500DW	○	1500	
	SUCASFDE3000DB	●	3000	
SUCASFDE3000DW	○	3000		

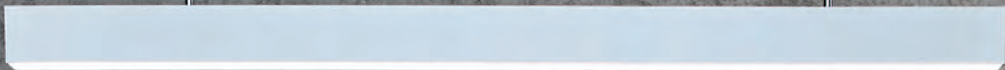

Fil 50



Fil 50
Opal



Fil 50
Prismatic

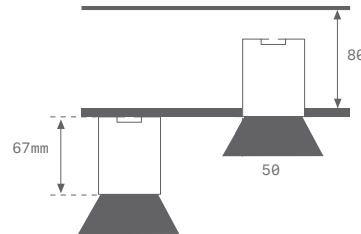

Fil 50
Slim

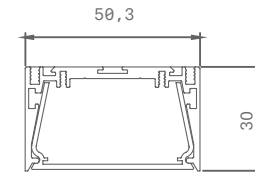
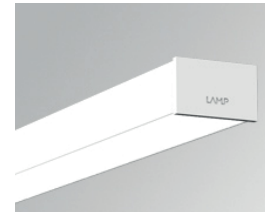

FIL 50

Family	Installation	Format	Lm LED/m	Optic	CRI	K	Gear	Finishes
F53	SF Surface RE Recessed	112 1123 mm	MO 2320lm	OP Opal PR Prismatic	8 80	30 3000 K 40 4000 K	N ON/OFF D DALI	W White 02
		168 1683 mm						G Grey 01
		HO 4288lm						OP Opal PR Prismatic
F53	SF	112	MO	OP	8	30	N	W

FIL 50 SLIM

Family	Installation	Format	Lm LED/m	Optic	CRI	K	Gear	Finishes
F51	SL Slim	112 1123 mm	MO 2320lm	OC Comfort	8 80	30 3000 K 40 4000 K	N ON/OFF D DALI	W White 02
		168 1683 mm						
F51	SL	112	MO	OP	8	30	N	W

TECHNICAL CHARACTERISTICS

Optics

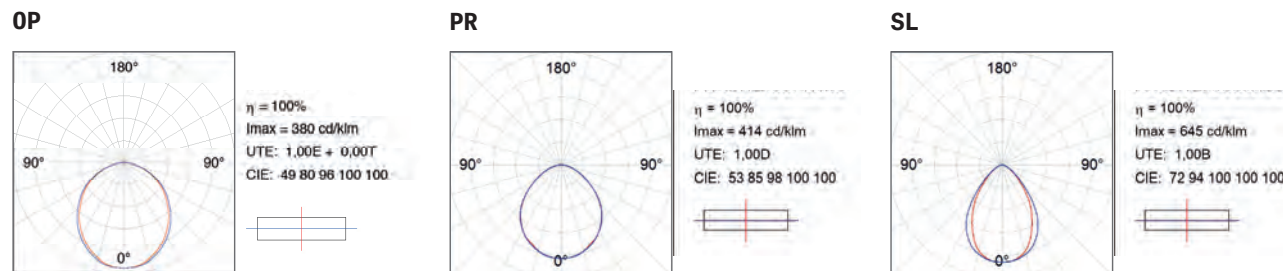



Light output and power

FIL 50

		1123mm				1683mm	
		K	CRI	W	lm Output	W	lm Output
MO	OP	3000	80	21,5	1966	31,2	2994
		4000	80	21,5	2085	31,2	3127
	PR	3000	80	21,5	2315	31,2	3473
		4000	80	21,5	2418	31,2	3627
HO	OP	3000	80	40,1	3846	59,1	5769
		4000	80	40,1	4030	59,1	6045
	PR	3000	80	40,1	4448	59,1	6672
		4000	80	40,1	4660	59,1	6990

FIL 50 SLIM

		1123mm				1683mm	
		K	CRI	W	lm Output	W	lm Output
MO	OC	3000	80	20,9	1922	30,8	2881
		4000	80	20,9	2017	30,8	2036





ACCESSORIES FOR SURFACE

Profile and cover Custom length



Ref.	Color
F5PRSUX/MMG	<input checked="" type="radio"/>
F5PRSUX/MMW	<input type="radio"/>
F5COX/MMG	<input checked="" type="radio"/>
F5COX/MMW	<input type="radio"/>

Opal polycarbonate diffuser max. 3m



Ref.	Color
F5DIX/MMOP	<input type="radio"/>

90° corner joint

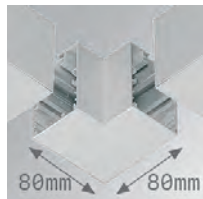

Ref.	Color
F5SUHCG	<input checked="" type="radio"/>
F5REHCW	<input type="radio"/>

End cover



Ref.	Color
F5SUECG	<input checked="" type="radio"/>
F5SUECW	<input type="radio"/>

Set of 2 fixings per joint 2 unit/ref



Ref.
F5J0

90° wall corner joint

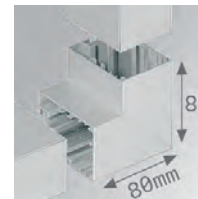

Ref.	Color
F5SFVCG	<input checked="" type="radio"/>
F7SFVCW	<input type="radio"/>



ACCESSORIES FOR SURFACE

Revolving end cover 2 unit/ref.

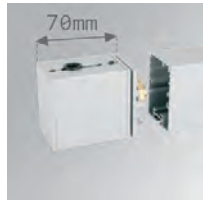

Ref.

F5JOR0EDG
F5JOR0EDW

Color



Pict.



Revolving intermediate cover 1 unit/ref.



Ref.

F5JOR0IDG
F5JOR0IDW

Color



Pict.



Wall bracket joint 2 unit/ref.



Ref.

F5FX75G
F5FX75W

Color



Lm

75
75

Adjustable wall bracket 2 unit/ref.

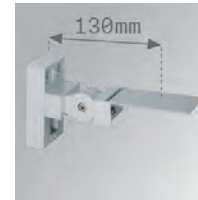

Ref.

ARR013G
ARRD170B

Color



Perpendicular wall bracket



Ref.

F5PRFXGR

Disposable wrist strap



Ref.

ELWRST



ACCESSORIES FOR RECESSED

Profile and cover Custom length



Ref.	Color
F5PRREX/MMG	●
F5PRREX/MMW	○
F5COX/MMG	●
F5COX/MMW	○

Opal polycarbonate diffuser max. 3m



Ref.	Color
F5DIX/MMOP	○

Set of 2 fixings per joint 2 unit/ref.



Ref.
F5J0

90° corner joint

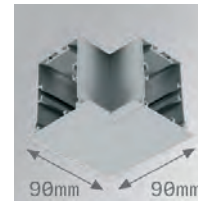

Ref.	Color
F5REHCG	●
F5REHCW	○

End cover

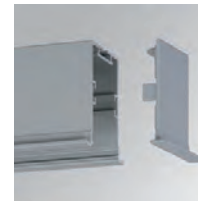

Ref.	Color
F5REECG	●
F5REECW	○

Disposable wrist strap



Ref.
ELWRST



ACCESSORIES

Recessed Basic Ceiling rose

Ref.	Color	h(mm)
SUCAREBA1500NB	●	1500
SUCAREBA1500NW	○	1500
SUCAREBA3000NB	●	3000
SUCAREBA3000NW	○	3000
DALI		
SUCAREBA1500DB	●	1500
SUCAREBA1500DW	○	1500
SUCAREBA3000DB	●	3000
SUCAREBA3000DW	○	3000

Recessed Deco Ceiling rose

Ref.	Color	h(mm)
SUCAREDE1500NB	●	1500
SUCAREDE1500NW	○	1500
SUCAREDE3000NB	●	3000
SUCAREDE3000NW	○	3000
DALI		
SUCAREDE1500DB	●	1500
SUCAREDE1500DW	○	1500
SUCAREDE3000DB	●	3000
SUCAREDE3000DW	○	3000

Height-adjustable steel cable

Ref.	Color	h(mm)
F52SUWIDE1500G	●	1500
F52SUWIDE3000G	●	3000
Quick anchorage		

Surface Basic Ceiling rose

Ref.	Color	h(mm)
SUCASFBA1500NB	●	1500
SUCASFBA1500NW	○	1500
SUCASFBA3000NB	●	3000
SUCASFBA3000NW	○	3000
DALI		
SUCASFBA1500DB	●	1500
SUCASFBA1500DW	○	1500
SUCASFBA3000DB	●	3000
SUCASFBA3000DW	○	3000

Surface Deco Ceiling rose

Ref.	Color	h(mm)
SUCASFDE1500NB	●	1500
SUCASFDE1500NW	○	1500
SUCASFDE3000NB	●	3000
SUCASFDE3000NW	○	3000
DALI		
SUCASFDE1500DB	●	1500
SUCASFDE1500DW	○	1500
SUCASFDE3000DB	●	3000
SUCASFDE3000DW	○	3000

Height-adjustable steel cable for electromechanical connection (3 or 5xØ1,5)

Ref.	Color	h(mm)
F52SUCAEMF1500NB	●	1500
F52SUCAEMF1500NW	○	1500
F52SUCAEMF3000NB	●	3000
F52SUCAEMF3000NW	○	3000
DALI		
F52SUCAEMF1500DB	●	1500
F52SUCAEMF1500DW	○	1500
F52SUCAEMF3000DB	●	3000
F52SUCAEMF3000DW	○	3000

Quick anchorage



Ind.



Fil 70



Fil 70
Opal

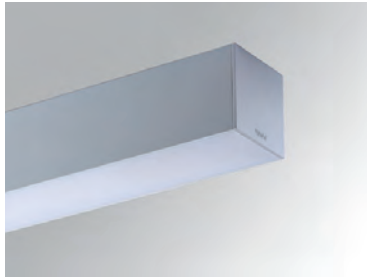

Fil 70
Prismatic



Fil 70
Corner

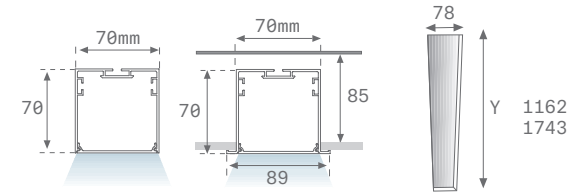
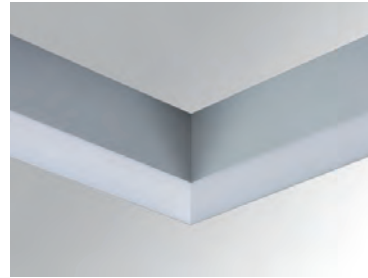

FIL 70

Family	Format	Installation	Format	Lm LED/m	Optic	CRI	K	Gear	Finishes
F71	- -	SF Surface	120 1162 mm	LO 2200lm	OP Opal	8 80	30 3000 K	N ON/OFF	W White 02
	- -	RE Recessed	170 1743 mm	HO 3800lm	PR Prismatic	8 80	40 4000 K	D DALI	G Grey 01
	HC Horizontal Corner	SF Surface	- -	LO 2200lm	OP Opal	8 80	30 3000 K	N ON/OFF	W White 02
		RE Recessed	- -	HO 3800lm	OP Opal	8 80	40 4000 K	N ON/OFF	G Grey 01
F71		SF	120	LO	OP	8	30	N	W

TECHNICAL CHARACTERISTICS

Optics

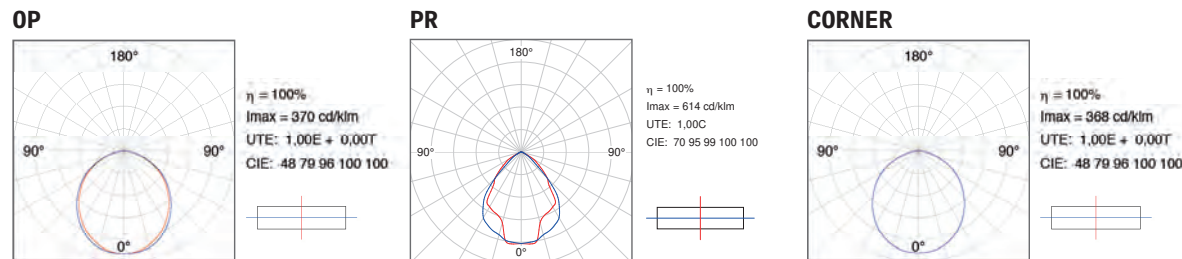

Light output and power

FIL 70		K	CRI	1162mm		1743mm	
				W	lm Output	W	lm Output
LO	OP	3000	80	17	1992	25	2988
		4000	80	17	2143	25	3215
PR	OP	3000	80	17	2219	25	3328
		4000	80	17	2300	25	3450
HO	OP	3000	80	28	3370	41	5055
		4000	80	28	3545	41	5318
PR	OP	3000	80	28	3507	41	5260
		4000	80	28	3635	41	5452





Fil 70
Direct/Indirect

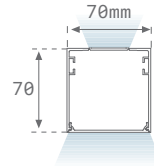

FIL 70 DIRECT INDIRECT

Family	Installation	Format	Lm LED	Optic	CRI	K	Gear	Finishes
F71	SF Suspended	120 1162mm	M0 3300	I0 Dir-Indir Opal	8 80	30 3000 K	N ON/OFF	W White 02
		170 1743mm						G Grey 01
F71	SF	120	M0	I0	8	30	N	W

TECHNICAL CHARACTERISTICS

Optics

I0

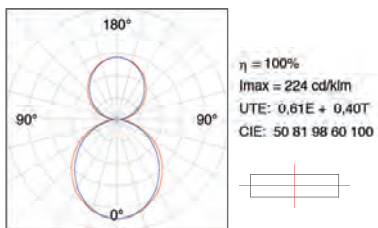

Light output and power

FIL 70 DIRECT/INDIRECT

	K	CRI	120mm		170mm	
			W	lm Output	W	lm Output
I0	3000	80	11,1	1069	15,8	1770
	3000	80	19	1806	26	2907
	4000	80	11,1	1244	15,8	1899
	4000	80	19	2101	26	3119





Fil 70 Tech Symmetric

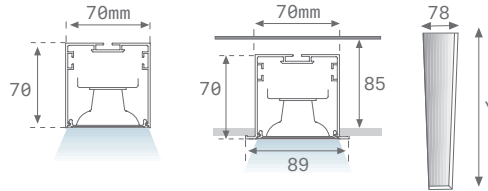

Fil 70 Tech Asymmetric

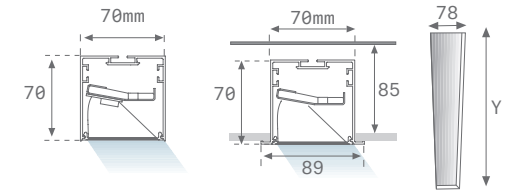

FIL 70 TECH

Family	Installation	Format	Lm LED/m	Optic	CRI	K	Gear	Finishes
F71	SF Surface	100 1000 mm	LO 1600lm MO 3200lm	TS Tech Symmetric	8 80	30 3000 K 40 4000 K	N ON/OFF D DALI	W White 02 G Grey 01
	RE Recessed			TA Tech Asymmetric				
		200 2000 mm	MO 3200lm HO 6400lm					
F71	SF	100	LO	TA	8	30	N	W

TECHNICAL CHARACTERISTICS

Optics

TS

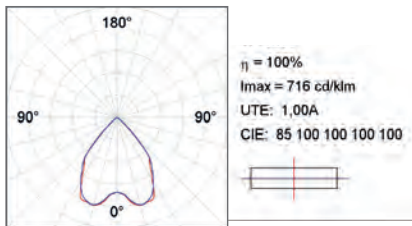

TA

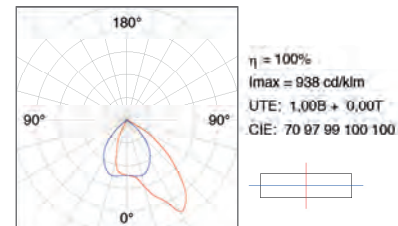

Light output and power

FIL 70 TECH	1000mm		2000mm			
	K	CRI	W	lm Output	W	lm Output
LO TS	3000	80	14,5	1530	-	-
	4000	80	12	1812	-	-
TA	3000	80	12	1388	-	-
	4000	80	12	1388	-	-
MO TS	3000	80	23,6	2400	26,8	3060
	4000	80	21	2872	25	3060
TA	3000	80	23,6	2032	25	2776
	4000	80	21	2032	25	2776
HO TS	3000	80	-	-	44,7	4800
	4000	80	-	-	42	4800
TA	3000	80	-	-	42	4064
	4000	80	-	-	42	4064





ACCESSORIES FOR SURFACE

Profile and cover Custom length

Image	Ref.	Color
	F7PRSUX/MMG	●
	F7PRSUX/MMW	○
	F7COSUX/MMG	●
	F7COSUX/MMW	○

Opal polycarbonate diffuser max. 3m

Image	Ref.	Color
	F7DIX/MMOP	○

90° wall corner

Image	Ref.	Color
	F7SFVCG	●
	F7SFVCW	○

ACCESSORIES FOR SUSPENSIONS

90° corner joint

Image	Ref.	Color
	F7TESUHCG	●
	F7TESUHCW	○

End cover

Image	Ref.	Color
	F7SUECG	●
	F7SUECW	○

Set of 2 fixings per joint 2 unit/ref

Image	Ref.
	F7J0

90° corner with polycarbonate diffuser

Image	Ref.	Color
	F7SUHCG	●
	F7SUHCW	○



ACCESSORIES FOR RECESSED

End cover

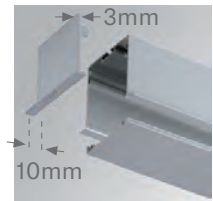

Ref.

F7REECG
F7REECW

Color



Profile and cover Custom length



Ref.

F7PRREX/MMG
F7PRREX/MMW
F7COSUX/MMG
F7COSUX/MMW

Color



90° corner with polycarbonate diffuser



Ref.

F7REHCG
F7REHCW

Color



ACCESSORIES

Disposable wrist strap



Ref.

ELWRST

Set of 2 fixings per joint 2 unit/ref.



Ref.

F7J0

90° corner joint

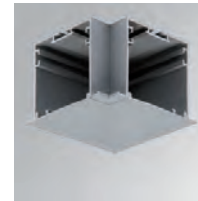

Ref.

F7TEREHCG
F7TEREHCW

Color



Opal Soft Tech 3 unit/ref.



Ref.

DIOPST1000

Lmm

1000
2000

unit

1
2



ACCESSORIES

Recessed Basic Ceiling rose

Ref.	Color	h(mm)
SUCAREBA1500NB	●	1500
SUCAREBA1500NW	○	1500
SUCAREBA3000NB	●	3000
SUCAREBA3000NW	○	3000
DALI		
SUCAREBA1500DB	●	1500
SUCAREBA1500DW	○	1500
SUCAREBA3000DB	●	3000
SUCAREBA3000DW	○	3000

Recessed Deco Ceiling rose

Ref.	Color	h(mm)
SUCAREDE1500NB	●	1500
SUCAREDE1500NW	○	1500
SUCAREDE3000NB	●	3000
SUCAREDE3000NW	○	3000
DALI		
SUCAREDE1500DB	●	1500
SUCAREDE1500DW	○	1500
SUCAREDE3000DB	●	3000
SUCAREDE3000DW	○	3000

Height-adjustable steel cable

Ref.	Color	h(mm)
F52SUWIDE1500G	●	1500
F52SUWIDE3000G	●	3000
Quick anchorage		

Surface Basic Ceiling rose

Ref.	Color	h(mm)
SUCASFBA1500NB	●	1500
SUCASFBA1500NW	○	1500
SUCASFBA3000NB	●	3000
SUCASFBA3000NW	○	3000
DALI		
SUCASFBA1500DB	●	1500
SUCASFBA1500DW	○	1500
SUCASFBA3000DB	●	3000
SUCASFBA3000DW	○	3000

Surface Deco Ceiling rose

Ref.	Color	h(mm)
SUCASFDE1500NB	●	1500
SUCASFDE1500NW	○	1500
SUCASFDE3000NB	●	3000
SUCASFDE3000NW	○	3000
DALI		
SUCASFDE1500DB	●	1500
SUCASFDE1500DW	○	1500
SUCASFDE3000DB	●	3000
SUCASFDE3000DW	○	3000

Height-adjustable steel cable for electromechanical connection (3 or 5xØ1,5)

Ref.	Color	h(mm)
F52SUCAEMF1500NB	●	1500
F52SUCAEMF1500NW	○	1500
F52SUCAEMF3000NB	●	3000
F52SUCAEMF3000NW	○	3000
DALI		
F52SUCAEMF1500DB	●	1500
F52SUCAEMF1500DW	○	1500
F52SUCAEMF3000DB	●	3000
F52SUCAEMF3000DW	○	3000

Quick anchorage



Ind.



Fil 120

Fil 120

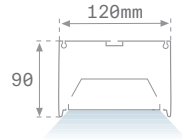

FIL 120

Family	Installation	Format	Lm LED	Optic	CRI	K	Gear	Finishes
F121	SF Surface	12 1162mm	HO 6500lm	OP Opal	8 80	30 3000 K 40 4000 K	N ON/OFF D DALI	W White 02
	RE Recessed	17 1743mm						G Grey 01
F121	SF	12	HO	OP	8	30	N	W

TECHNICAL CHARACTERISTICS

Optics

OP

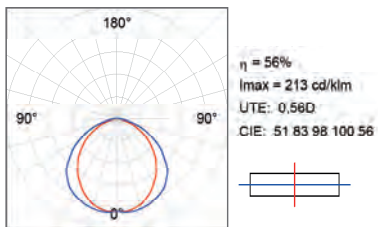

Light output and power

FIL 120

	K	CRI	1162mm		1743mm	
			W	lm Output	W	lm Output
HO	3000	80	49,2	5090	71,7	7735
	4000	80	49,2	5437	71,7	8156



ACCESSORIES FOR RECESSED

90° corner joint

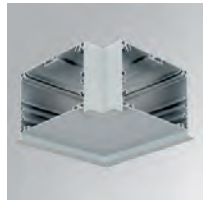

Ref.

F12REHCW
F12REHCG

Color



Aluminium end cover



Ref.

F12REECG
F12REECW

Color



Recessed profile and over Custom length

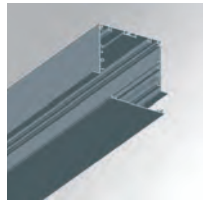

Ref.

F12PRREX/MMG
F12PRREX/MMW
F12COX/MMG
F12COX/MMW

Color



WALL BRACKETS: Fil 50, Fil 70, Fil 120, Lamptub (1unit/ref.)

Short wall bracket joint 2 unit/ref.

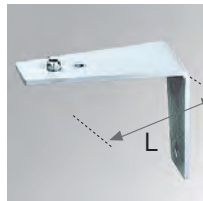

Ref.

F5FX75W
F5FX75G

Color



Lmm

75

75

Set of 2 fixings per joint



Ref.

F7J0

Adjustable wall bracket 2 unit/ref.



Ref.

ARRO13W
ARRO13G

Color

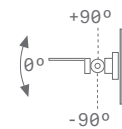

Adjustable and extensible wall bracket 2 unit/ref.

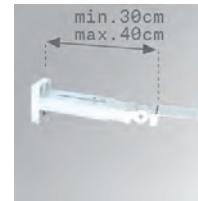

Ref.

ARROEX40W
ARROEX40G

Color

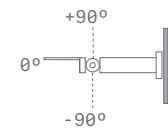

ACCESSORIES FOR SURFACE

Profile and cover Custom length

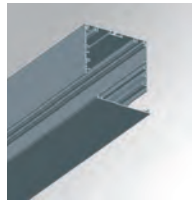
	Ref.	Color
	F12PRSUX/MMW	<input type="radio"/>
	F12PRSUX/MMG	<input checked="" type="radio"/>
	F12COX/MMW	<input type="radio"/>
	F12COX/MMG	<input checked="" type="radio"/>

Opal polycarbonate diffuser max. 3m

	Ref.	Color
	F12DIX/MMOP	<input type="radio"/>

90° corner joint

	Ref.	Color
	F12SUHCW	<input type="radio"/>
	F12SUHCG	<input checked="" type="radio"/>

Aluminium end cover

	Ref.	Color
	F12SUECW	<input type="radio"/>
	F12SUECG	<input checked="" type="radio"/>

90° wall corner

	Ref.	Color
	F12SFVCW	<input type="radio"/>
	F12SFVCG	<input checked="" type="radio"/>

"T" joint

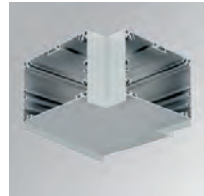
	Ref.	Color
	F12SUTJW	<input type="radio"/>
	F12SUTJG	<input checked="" type="radio"/>

ACCESSORIES FOR SURFACE

"Cross" joint



Ref.

F12SUXJW
F12SUXJG

Color



Revolving end cover



Ref.

F12JOR0EDW
F12JOR0EDG

Color



Revolving intermediate cover



Ref.

F12JOR0IDW
F12JOR0IDG

Color





SUSPENSIONS: Fil 120, BCN, STGO (1unit/ref.)

Two steel cables electromechanical suspension

Ref.	Color	h(m)
SUEM2W3000NW	○	max. 3
SUEM2W3000NG	●	max. 3

Two steel cables

Ref.	Color	h(m)
SU2W3000NW	○	max. 3
SU2W3000NG	●	max. 3

Recessed Basic Ceiling rose

Ref.	Color	h(mm)
SUCAREBA1500NB	●	1500
SUCAREBA1500NW	○	1500
SUCAREBA3000NB	●	3000
SUCAREBA3000NW	○	3000
DALI		
SUCAREBA1500DB	●	1500
SUCAREBA1500DW	○	1500
SUCAREBA3000DB	●	3000
SUCAREBA3000DW	○	3000

Surface Basic Ceiling rose

Ref.	Color	h(mm)
SUCASFBA1500NB	●	1500
SUCASFBA1500NW	○	1500
SUCASFBA3000NB	●	3000
SUCASFBA3000NW	○	3000
DALI		
SUCASFBA1500DB	●	1500
SUCASFBA1500DW	○	1500
SUCASFBA3000DB	●	3000
SUCASFBA3000DW	○	3000

Recessed Deco Ceiling rose

Ref.	Color	h(mm)
SUCAREDE1500NB	●	1500
SUCAREDE1500NW	○	1500
SUCAREDE3000NB	●	3000
SUCAREDE3000NW	○	3000
DALI		
SUCAREDE1500DB	●	1500
SUCAREDE1500DW	○	1500
SUCAREDE3000DB	●	3000
SUCAREDE3000DW	○	3000

Surface Deco Ceiling rose

Ref.	Color	h(mm)
SUCASFDE1500NB	●	1500
SUCASFDE1500NW	○	1500
SUCASFDE3000NB	●	3000
SUCASFDE3000NW	○	3000
DALI		
SUCASFDE1500DB	●	1500
SUCASFDE1500DW	○	1500
SUCASFDE3000DB	●	3000
SUCASFDE3000DW	○	3000



Fine LED

Fine LED Strip
IP20/65

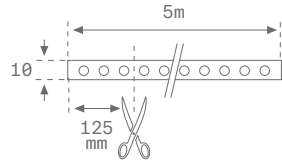

FINE LED STRIP

Family	Installation	Format	Lm LED/m	IP	CRI	K	Gear
F2	SF Surface	500 5000mm	L0 1500lm	20 20 65 65	8 80 9 90	30 3000 40 4000 TW Tunable White	0 Not Included
F2	SF	500	L0	20	8	30	0

TECHNICAL CHARACTERISTICS

Optics

IP20

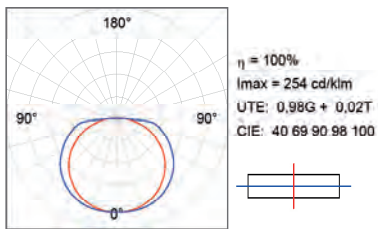

IP65

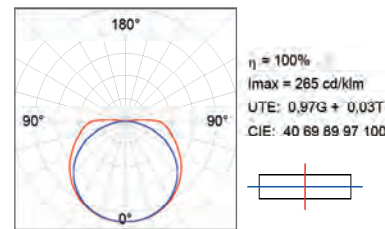

Light output and power

FINE LED STRIP

	K	CRI	5000mm		W/1m	lm Output/1m
			W	lm Output		
LO	3000	80	48	7710	9,6	1542
	4000	80	48	8095	9,6	1619



On/Off scheme



DALI scheme

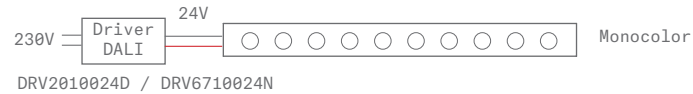

Dimming scheme

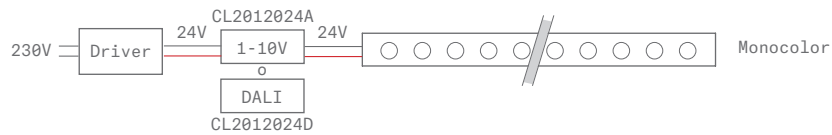

ACCESSORIES

Opal polycarbonate diffuser



L **Ref.**
2m **FIDI20000P**

Transparent polycarbonate diffuser



L **Ref.**
2m **FIDI2000TR**

6 mm surface profile and covers



L **Ref.**
2m ● **FIPRSU062000N**
- ● **FISUEC060HG**
- ● **FISUEC061HG**

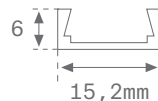

6 mm recessed profile and covers



L **Ref.**
2m ● **FIPRE062000N**
- ● **FIREEC060HG**
- ● **FIREEC061HG**

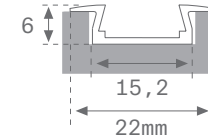

12 mm surface profile and covers 12 mm



L **Ref.**
2m ● **FICOSU122000N**
- ● **FISUEC120HG**
- ● **FISUEC121HG**

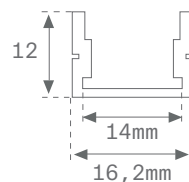

12 mm recessed profile and covers



L **Ref.**
2m ● **FIPRE122000N**
- ● **FIREEC120HG**
- ● **FIREEC121HG**

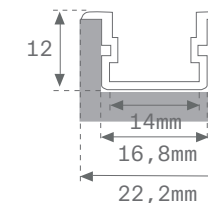

ACCESSORIES

Tilt 45° profile and covers



L Ref.

2m

-

-

● FIC0SU452000N

● FISUEC450HG

● FISUEC451HG



Tilt 45° profile fixing clip 1 unit. / ref.



Ref.

FISUBR45

Disposable wrist strap



Ref.

ELWRST

End cover



End cover with exit hole for the cable

6/12 mm surface profile fixing clip 1 unit. / ref.



Ref.

FISUBR

Fine Curve

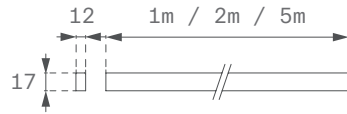

FINE CURVE

Family	Format	Lm LED/m	IP	Optic	CRI	K	Gear	Finishes
FC2	100 1000mm	L0 500lm	67	OP Opal	9 90	27 2700	0 Not Included	W White
	200 2000mm	30 3000						
	500 5000mm	40 4000						
FC2	100	L0	67	OP	9	30	0	W

TECHNICAL CHARACTERISTICS

Optics

OP

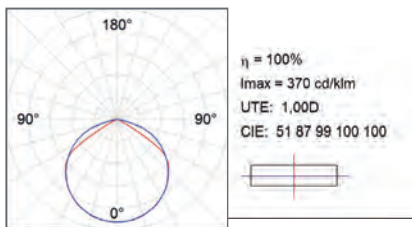

Light output and power

FINE CURVE

	K	CRI	1000mm		2000mm		5000mm	
			W	lm Output	W	lm Output	W	lm Output
OP	2700	90	10	410	20	820	50	2050
	3000	90	10	420	20	840	50	2100
	4000	90	10	450	20	900	50	2250



ACCESSORIES

Surface profile fixing lip 1 unit. / ref.



Ref.
FC1FX30G
1mt: 3 unit.
2mts: 5 unit.
5mts: 11 unit.

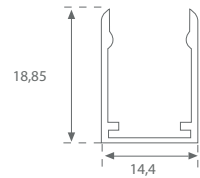

Surface flexible profile 1 unit. / ref.



Ref.
FCFX500W



GEARS

LED power supply



W	Ref.	V	IP	Reg.
60	DRV20602430N	24	20	ON/OFF
60	DRV206024D	24	20	DALI
20	DRV202024N	24	20	ON/OFF
80	DRV688024N	24	66	ON/OFF
100	DRV2010024D	24	20	DALI
100	DRV6710024N	24	67	ON/OFF
60	DRV676024D	24	67	DALI
75	DRV677524N	24	67	ON/OFF

IP67 4 poles connector



Ref.
CT4P67N

Monocolor strip regulation controller (PWM)



W	Ref.	V	Control	Pict.
120	CL2012024A	24	1-10V	
120	CL2012024D	24	DALI	



Hance 48V



Hance 48V
Track 500lm

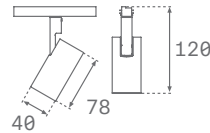

HANCE 48V 500

Family	Installation	Lm LED	Optics	CRI	K	Gear	Acc. Finishes	Finishes
HS1	TL Track 48V	05 500lm	SP SP 13° MF MFL 19° FL FL 26°	8 80	27 2700 K 30 3000 K 40 4000 K	N ON/OFF D DALI	B Black	W White 03 B Black 03
HS1	TL	05	SP	8	27	N	B	W

TECHNICAL CHARACTERISTICS

Optics

SP 13°

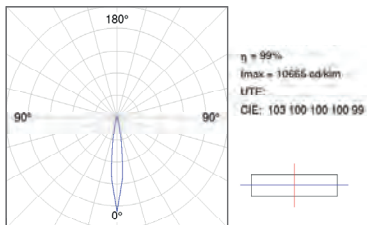

MFL 19°

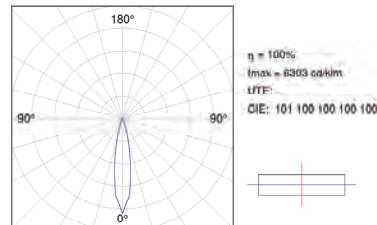

FL 26°

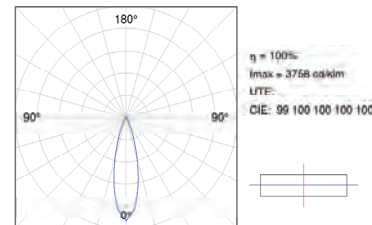

Light output and power

HANCE 48V 500

		500lm			
		K	CRI	W	lm Output
SP 13°	2700	80	6,1	314	
	3000	80	6,1	314	
	4000	80	6,1	339	
MFL 16°	2700	80	6,1	330	
	3000	80	6,1	330	
	4000	80	6,1	356	
FL 26°	2700	80	6,1	324	
	3000	80	6,1	324	
	4000	80	6,1	349	





ACCESSORIES

Transparent diffuser



Ref.
HSTR25

Soft Lens



Ref.
HSSL25

Refractor for elliptical distribution of luminous flux



Ref.
HSEL25

Anti-glare honeycomb grille

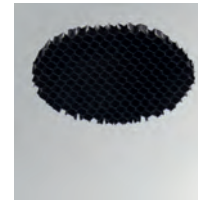

Ref.
HSR025

Decorative Ring



Ref.
HSRI65W
HSRI65C
HSRI65M

Color

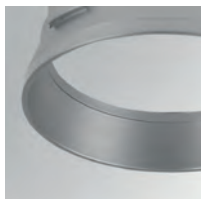

Buffer



Ref.
HSCU25



Hance 48V
Track 1000/2000lm

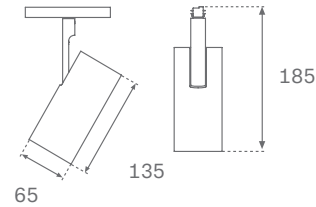

HANCE 48V 1000/2000

Family	Installation	Lm LED	Optics	CRI	K	Gear	Acc. Finishes	Finishes
HS1	TL Track 48V	10 700lm	SS SSP 10°	8 80	27 2700 K	N ON/OFF	B Black 01	W White 01
		20 1000lm						B Black 01
		10 1000lm	SP SP 17°	40 4000 K	D DALI			
20 2000lm	MF MFL 23°							
			FL FL 37°					
HS1	TL	10	SS	8	27	N	B	W





TECHNICAL CHARACTERISTICS

Optics

SSP 10°

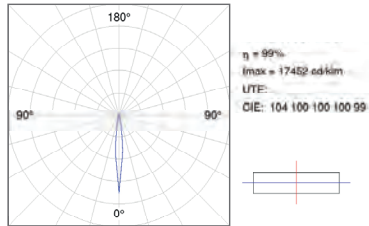

SP 17°

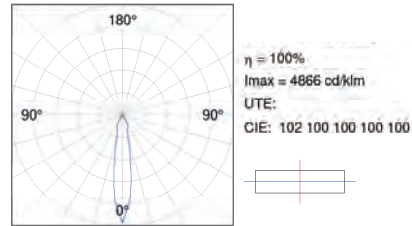

MFL 23°

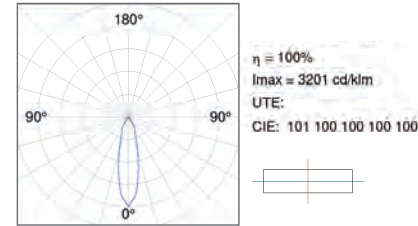

FL 37°

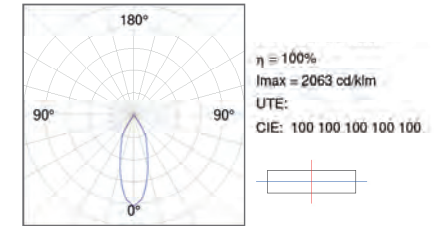

Light output and power

HANCE 48V 700/1000/2000lm

	K	CRI	700lm		1000lm		2000lm	
			W	lm Output	W	lm Output	W	lm Output
SSP 10°	2700	80	9	498	-	-	-	-
	3000	80	9	605	-	-	-	-
	4000	80	9	700	-	-	-	-
SP 17°	2700	80	-	-	9,4	928	16,9	1511
	3000	80	-	-	9,4	947	16,9	1542
	4000	80	-	-	9,4	1003	16,9	1633
MFL 23°	2700	80	-	-	9,4	865	16,9	1281
	3000	80	-	-	9,4	883	16,9	1307
	4000	80	-	-	9,4	935	16,9	1384
FL 37°	2700	80	-	-	9,4	955	16,9	1569
	3000	80	-	-	9,4	974	16,9	1600
	4000	80	-	-	9,4	1032	16,9	1695



ACCESSORIES

Transparent diffuser



Ref.
HSTR50

● Can not be mounted on SSP models

Soft Lens



Ref.
HSSL50

Refractor for elliptical distribution of luminous flux



Ref.
HSEL50

Anti-glare honeycomb grille

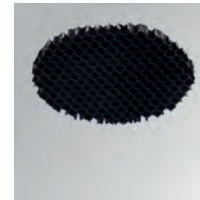

Ref.
HSO50

● Can not be mounted on SSP models

Decorative Ring



Ref.
HSRI65W
HSRI65C
HSRI65M

Color

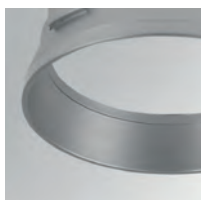

Buffer



Ref.
HSCU50

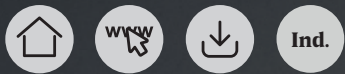

Hance Downlight

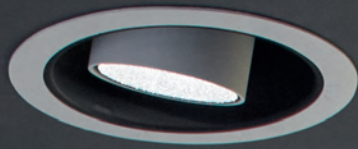

DOWNLIGHT

Family	Installation	Lm LED	Optic	CRI	K	Gear	Finishes
HD2	RE Recessed	07 700lm	SS SSP 10°	9 90	30 3000K	N ON/OFF	W White 03
	SR Semi-Recessed	10 1000lm					
		10 1000lm	SP SP 16°	8 80			
		20 2000lm	MF MFL 23°	9 90			
		30 3000lm	FL FL 34°				
	40 4000lm						
HD2	RE	10	SS	9	30	N	W



Hance Downlight
Recessed 1000/2000lm

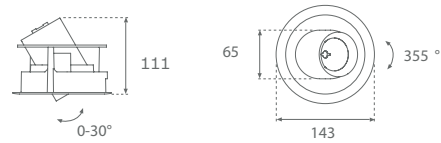

Hance Downlight
Semi-Rec 1000/2000lm

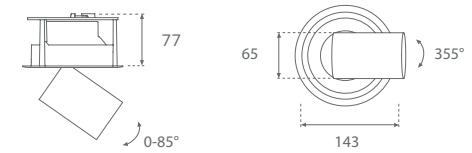

Hance Downlight
Recessed 3000/4000lm

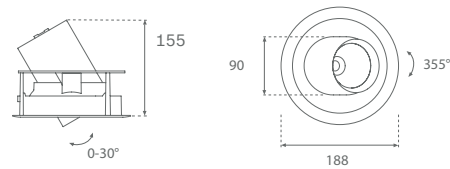

Hance Downlight
Semi Recessed 3000/4000lm

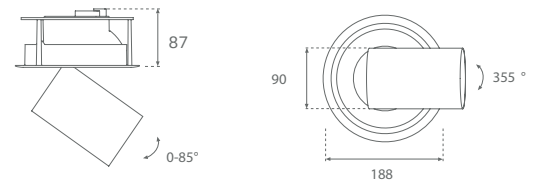



TECHNICAL CHARACTERISTICS

Optics

700/1000lm

SSP 10°

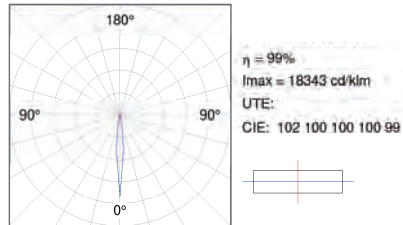

1000/2000lm

SP 16°

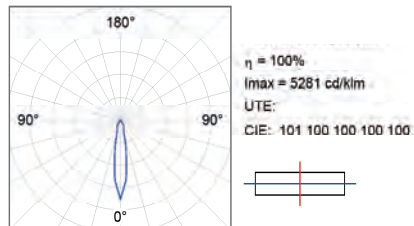

FL 23°

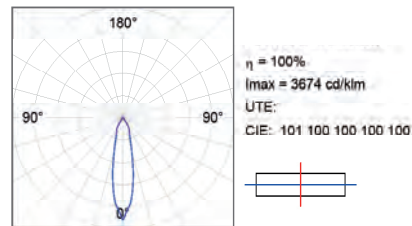

FL 34°

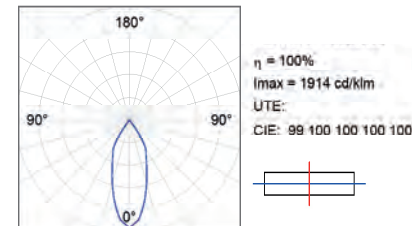

3000/4000lm

SP 16°

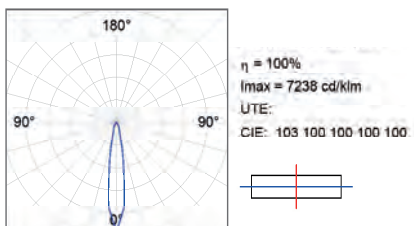

MFL 23°

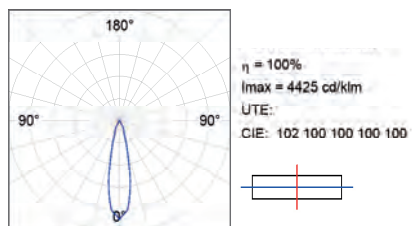

FL 32°

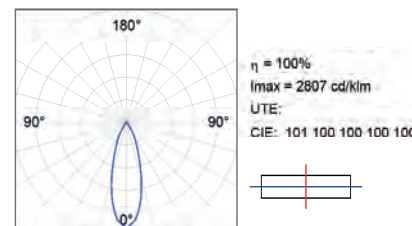



Light output and power

HANCE DOWNLIGHT

	K		700lm		1000lm		2000lm		3000lm		4000lm	
			W	lm Output	W	lm Output	W	lm Output	W	lm Output	W	lm Output
SSP 10°	3000	90	8,6	438	13,9	652	-	-	-	-	-	-
	4000	90	8,6	492	13,9	737	-	-	-	-	-	-
SP 16°	3000	80	-	-	8,6	955	20,8	2204	28,3	3233	36,7	4440
	4000	80	-	-	8,6	1054	20,8	2335	28,3	3419	36,7	4694
	3000	90	-	-	8,6	853	20,8	1889	28,3	2759	36,7	3789
	4000	90	-	-	8,6	899	20,8	1992	28,3	2911	36,7	3994
MFL 23°	3000	80	-	-	8,6	1022	20,8	2267	28,3	3356	36,7	4343
	4000	80	-	-	8,6	1071	20,8	2402	28,3	3549	36,7	4591
	3000	90	-	-	8,6	876	20,8	1943	28,3	2864	36,7	3706
	4000	90	-	-	8,6	924	20,8	2049	28,3	3022	36,7	3907
FL 34°	3000	80	-	-	8,6	1011	20,8	2238	28,3	3138	36,7	4225
	4000	80	-	-	8,6	1083	20,8	2371	28,3	3318	36,7	4467
	3000	90	-	-	8,6	867	20,8	1918	28,3	2978	36,7	3606
	4000	90	-	-	8,6	914	20,8	2022	28,3	2826	36,7	3800



ACCESSORIES

Transparent diffuser



Ref.

- HSTR50** - Downlight 700/1000/2000
- HS2TR75** - Downlight 3000/4000

● **Can not be mounted on SS models**

Soft Lens



Ref.

- HSSL50** - Downlight 700/1000/2000
- HSSL75** - Downlight 3000/4000

Refractor for elliptical distribution of luminous flux



Ref.

- HSEL50** - Downlight 700/1000/2000
- HSEL75** - Downlight 3000/4000

Anti-glare honeycomb grille

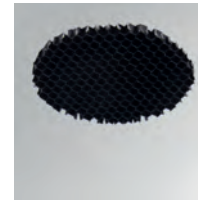

Ref.

- HSH050** - Downlight 700/1000/2000
- HS2H075** - Downlight 3000/4000

● **Can not be mounted on SS models**

Decorative Ring



Ref.

- HSRI65W** - Downlight 700/1000/2000
- HSRI65C** - Downlight 700/1000/2000
- HSRI65M** - Downlight 700/1000/2000

Color

-
-
-



- HS2RI90W** - Downlight 3000/4000
- HS2RI90C** - Downlight 3000/4000
- HS2RI90M** - Downlight 3000/4000

-
-
-

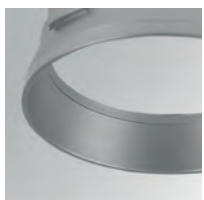

Buffer



Ref.

- HSCU50** - Downlight 700/1000/2000
- HSCU75** - Downlight 3000/4000



Hance Spotlight



HANCE SPOTLIGHT

Family	Installation	Lm LED	Optic	CRI	K	Gear	Finishes
HS2	TK Track	07 700lm	SS SSP 10°	9 90	30 3000 K	N ON/OFF	W White 03
	SF Surface	10 1000lm					
	SR Semi-Recessed	10 1000lm	SP SP 16-17°	8 80			
		20 2000lm	MF MFL 23-24°	9 90			
		30 3000lm	FL FL 36-37°				
		40 4000lm					
HS2	TK	10	SP	8	30	N	W



Hance Spotlight Superspot Track 700-1000



700/1000 ON OFF

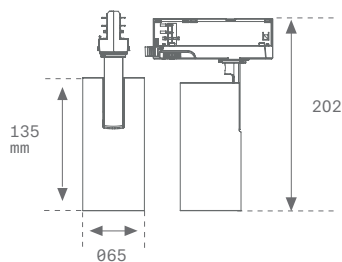

700/1000 DALI

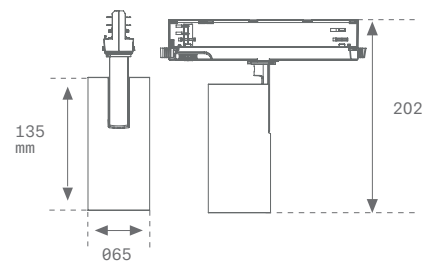

Hance Spotlight Superspot Surface 700-1000



700 ON-OFF

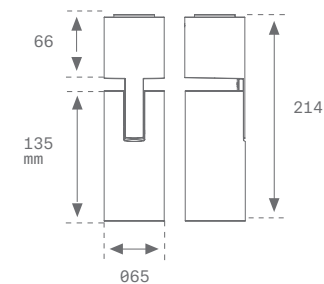

700 DALI - 1000 ON-OFF/DALI

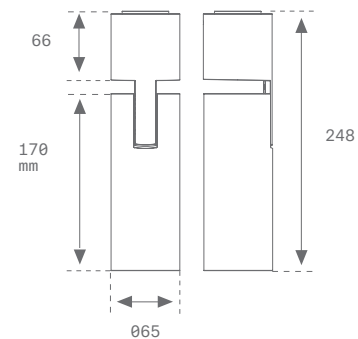

Hance Spotlight Superspot Semi-Rec 700-1000



700/1000 ON-OFF/DALI

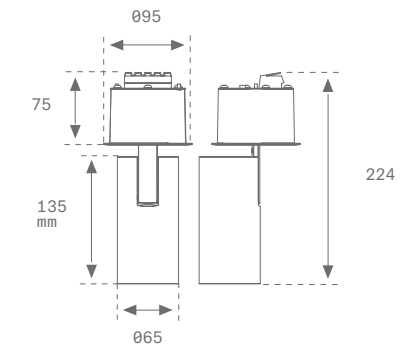



Hance Spotlight Track 1000-2000



1000/2000 ON OFF

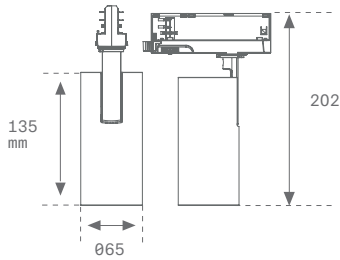

1000/2000 DALI

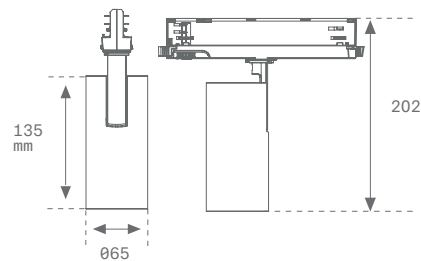

Hance Spotlight Surface 1000-2000



1000 ON-OFF

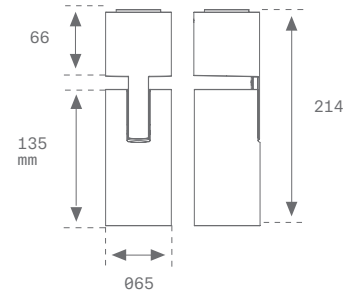

1000 DALI - 2000 ON-OFF/DALI

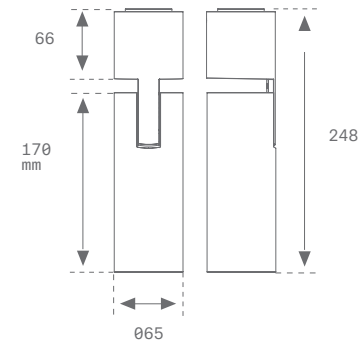

Hance Spotlight Semi-Rec 1000-2000



1000/2000 ON-OFF/DALI

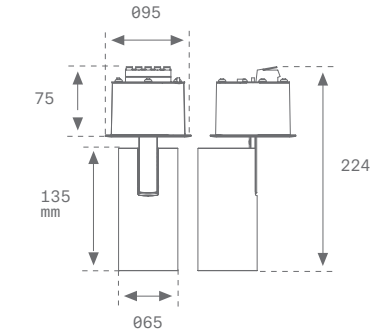

Hance Spotlight
Track 3000-4000



3000/4000 ON OFF

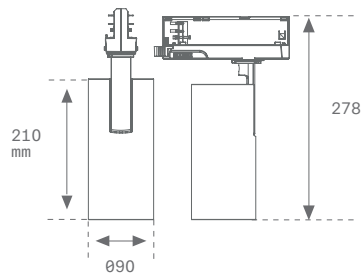

3000/4000 DALI

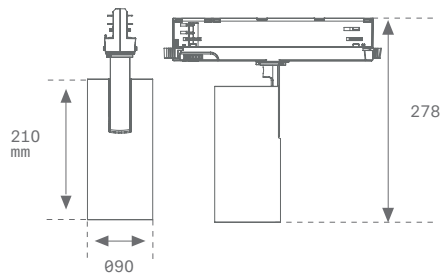

Hance Spotlight
Surface 3000-4000

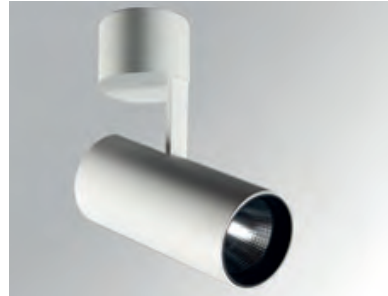

3000/4000 ON OFF/DALI

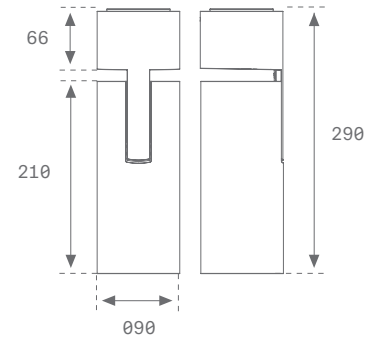

Hance Spotlight
Semi-Rec 3000-4000



3000/4000 ON OFF/DALI

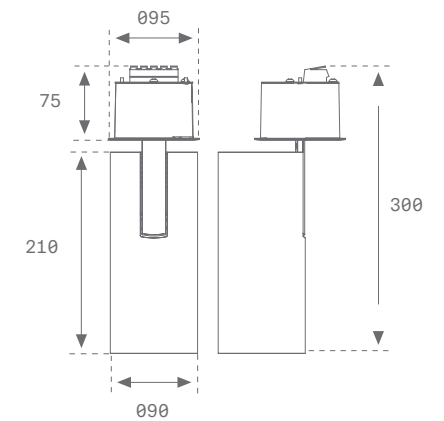



Light output and power

HANCE SPOTLIGHT

	K		700lm		1000lm		2000lm		3000lm		4000lm	
			W	lm Output	W	lm Output	W	lm Output	W	lm Output	W	lm Output
SSP 10°	3000	90	8,6	438	13,9	652	-	-	-	-	-	-
	4000	90	8,6	492	13,9	737	-	-	-	-	-	-
SP 16°	3000	80	-	-	8,6	955	20,8	2204	28,3	3233	36,7	4440
	4000	80	-	-	8,6	1054	20,8	2335	28,3	3419	36,7	4694
	3000	90	-	-	8,6	853	20,8	1889	28,3	2759	36,7	3789
	4000	90	-	-	8,6	899	20,8	1992	28,3	2911	36,7	3994
MFL 23°	3000	80	-	-	8,6	1022	20,8	2267	28,3	3356	36,7	4343
	4000	80	-	-	8,6	1071	20,8	2402	28,3	4549	36,7	4591
	3000	90	-	-	8,6	876	20,8	1943	28,3	2864	36,7	3706
	4000	90	-	-	8,6	924	20,8	2049	28,3	3022	36,7	3907
FL 34°	3000	80	-	-	8,6	1011	20,8	2238	28,3	3138	36,7	4225
	4000	80	-	-	8,6	1083	20,8	2371	28,3	3318	36,7	4467
	3000	90	-	-	8,6	867	20,8	1918	28,3	2978	36,7	3606
	4000	90	-	-	8,6	914	20,8	2022	28,3	2826	36,7	3800



TECHNICAL CHARACTERISTICS

Optics

700/1000lm

SSP 10°

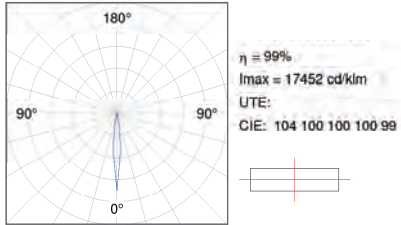

1000/2000lm

SP 16-17°

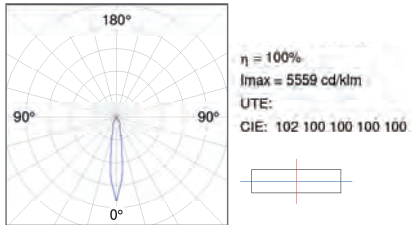

MFL 23-24°

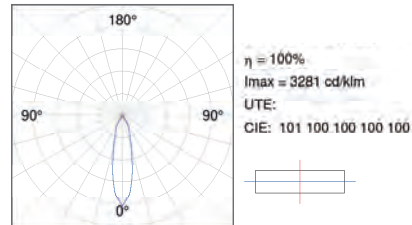

FL 36-37°

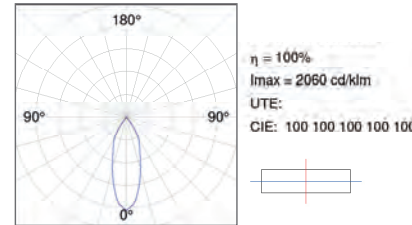

3000/4000lm

SP 16°

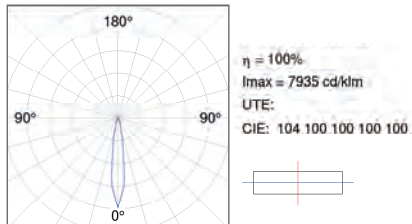

MFL 23°

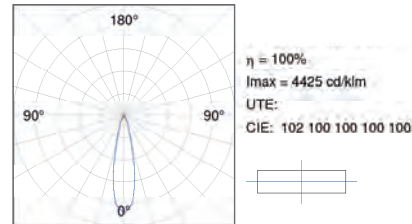

FL 34°

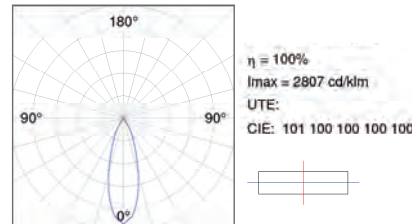

ACCESSORIES

Transparent diffuser



Ref.
HSTR50 - Spotlight 700/1000/2000
HS2TR75 - Spotlight 3000/4000

● **Can not be mounted on SS models**

Soft Lens



Ref.
HSSL50 - Spotlight 700/1000/2000
HSSL75 - Spotlight 3000/4000

Refractor for elliptical distribution of luminous flux



Ref.
HSEL50 - Spotlight 700/1000/2000
HSEL75 - Spotlight 3000/4000

Anti-glare honeycomb grille

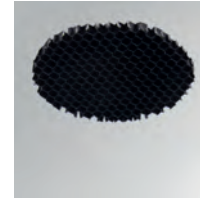

Ref.
HSH050 - Spotlight 700/1000/2000
HS2H075 - Spotlight 3000/4000

● **Can not be mounted on SS models**

Decorative Ring



Ref. **Color**
HSRI65W - Spotlight 700/1000/2000
HSRI65C - Spotlight 700/1000/2000
HSRI65M - Spotlight 700/1000/2000



HS2RI90W - Spotlight 3000/4000
HS2RI90C - Spotlight 3000/4000
HS2RI90M - Spotlight 3000/4000

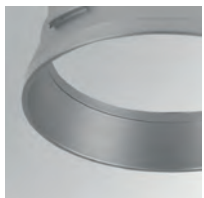

Buffer



Ref.
HSCU50 - Spotlight 700/1000/2000
HSCU75 - Spotlight 3000/4000

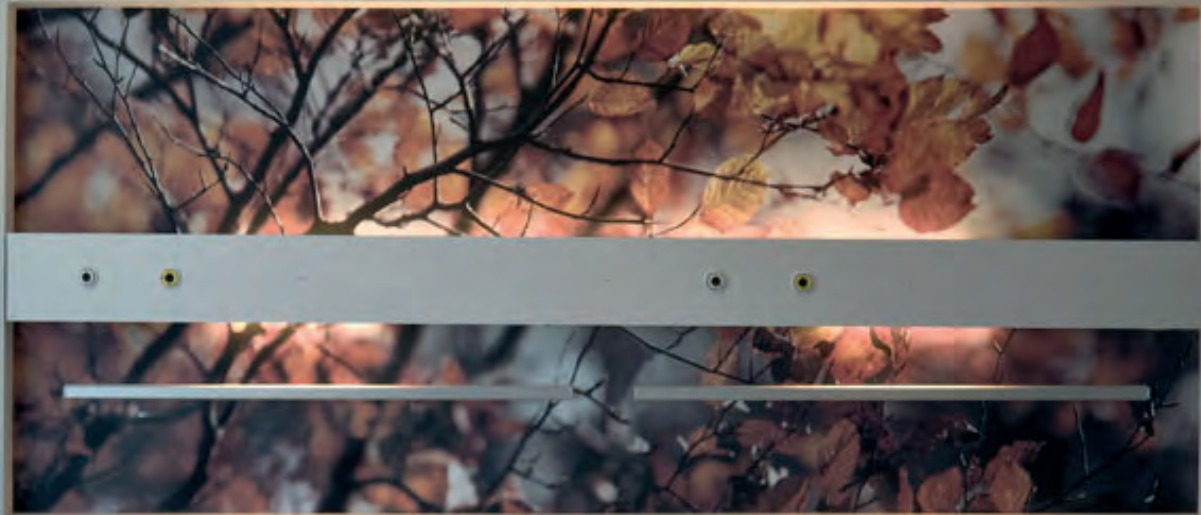

Health & Wellness

Clinic

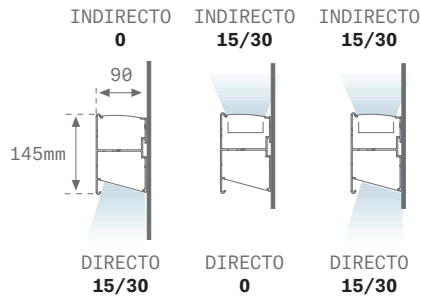
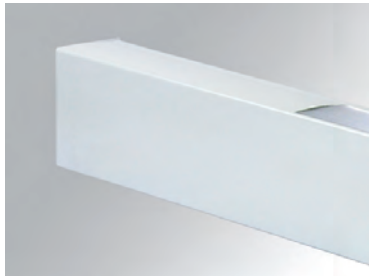

CLINIC

Family	Format	Lm LED Dir.	Lm LED Ind.	CRI	K	Gear	Finishes
CL1	120 1173	15 1620 lm	15 1620 lm	8 80	40 4000 K	N ON/OFF	W White 01
	175 1756	30 3240 lm 15 1620 lm	30 3240 lm 15 1620 lm				
CL1	120	15	15	8	40	N	W

CLINIC TW

Family	Format	Optics	Lm LED	CRI	K	Gear
CL1	058 1173mm	DR Direct	M0	8 80	TW Tunable White	D DALI
	115 1150mm	ID Indirect				
CL1	058	DR	M0	8	TW	D



TECHNICAL CHARACTERISTICS

Optics

DIRECT

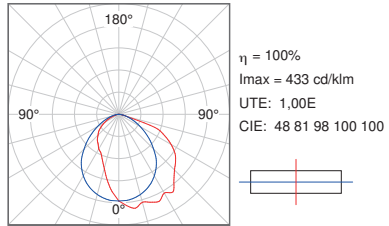

INDIRECT

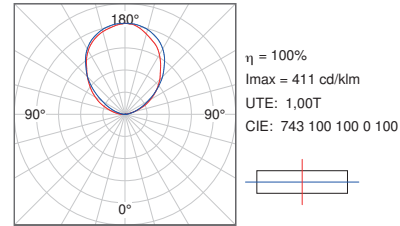

Light output and power

CLINIC

				1173mm		1756mm	
		K	CRI	W	lm Output	W	lm Output
LO	DIR	4000	80	12	1150	12	1150
	IND	4000	80	12	1150	12	1150
	DIR LO / IND LO	4000	80	24	2300	24	2300
LO/HO	DIR LO / IND HO	4000	80	36	3450	36	3450
HO	DIR	4000	80	24	2300	24	2300
	IND	4000	80	24	2300	24	2300

CLINIC TW

				580mm		1150mm	
		K	CRI	W	lm Output	W	lm Output
HO	DIR	TW	80	16,5	1629	31,6	3258
	IND	TW	80	16,5	1716	31,6	3432

Clinic Gas

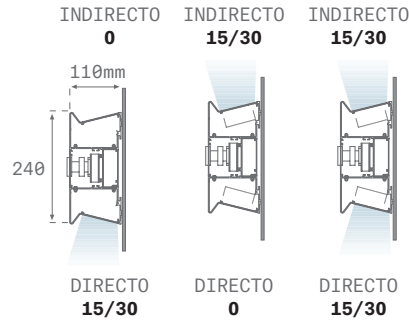

CLINIC GAS

Family	Format	Lm LED Dir.	Lm LED Ind.	Gas connection	CRI	K	Gear	Finishes
CG1	185 1856	30 3240 lm	30 3240 lm	1 1 ●	8 80	40 4000 K	N ON/OFF	W White 01
		15 1620 lm	15 1620 lm	2 2 ●				
				3 3 ●				
CG1	185	30	30	1	8	40	N	W

TECHNICAL CHARACTERISTICS

DIRECT

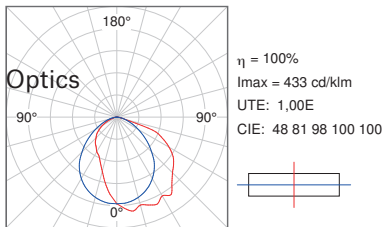

INDIRECT

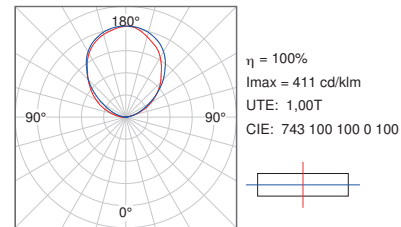

		1856mm											
DIR	LO	Gas	K	CRI	W	lm Output	DIR/IND	DIR HO/IND LO	Gas	K	CRI	W	lm Output
		1G	4000	80	12	1150		1G	4000	80	36	3450	
		2G						2G					
		3G						3G					
	HO	1G	4000	80	24	2300							
		2G											
		3G											
	IND LO	1G	4000	80	12	1150							
		2G											
		3G											
	HO	1G	4000	80	24	2300							
		2G											
		3G											



ACCESSORIES

● 1 medical gas outlet



Ref.
1

● 2 medical gas outlets

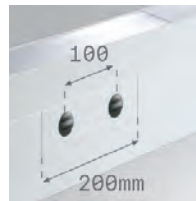

Ref.
2

● 3 medical gas outlets

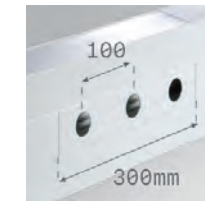

Ref.
3

Single-pole switch



Ref.
CLAC1PIN

Color
○

Double single-pole switch



Ref.
CLAC1PDB

Color
○

Schuko socket outlet



Ref.
CLACSK

Color
○

Two way switch



Ref.
CLAC2PIN

Color
○

Pull cord



Ref.
CLACTPUSH

Color
○

Schuko socket outlet (France)



Ref.
CLACSKFR

Color
○



ACCESSORIES

Single-pole pull switch



Ref.

CLACTSW

Color



Blank cover



Ref.

CLACCO

Color



Night light



Ref.

CLACNL

Color



RJ-45 connector



Ref.

CLACRJ45

Remote push-button



Ref.

CLACPUSH

Color



Call and presence push button



Ref.

CLACCPUSH

Color



Remote control



Ref.

CLACRC

Color





Hermética

Hermética

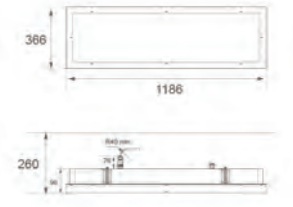
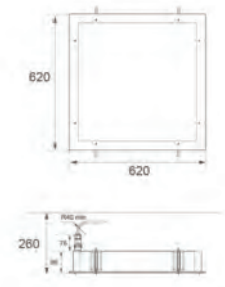

HERMÉTICA

Family	Format	Lm LED	IP	Optic	CRI	K	Gear	Finishes
HM2	060 600x600mm	55 5600lm	65 IP65	OP Opal	8 80	30 3000 K	N ON-OFF	W White 04
	120 1200x300mm			PR Prismatic				
HM2	060	55	65	OP	8	40	D	W

TECHNICAL CHARACTERISTICS

Optics

OP

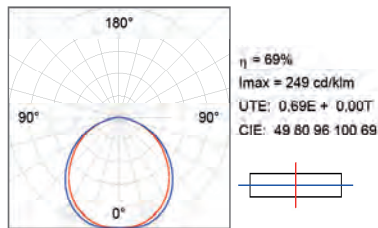

PR

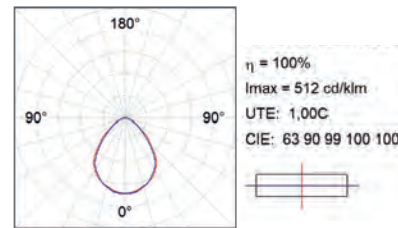

Light output and power

	K	CRI	W	600x600mm		1200x300mm	
				W	lm Output	W	lm Output
OP	3000	80	35	4390	35	4390	
	4000	80	35	4600	35	4600	
PR	3000	80	35	4328	35	4328	
	4000	80	35	4535	35	4535	





Imag



Imag G3
Track

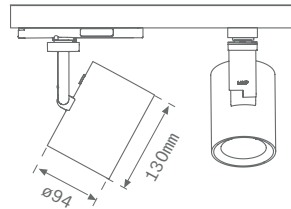

IMAG G3

Family	Format	Lm LED	Optic	CRI	K	Gear	Finishes
IM3	TK Track	20 2000lm	SP SP 15°-20°	9 90	30 3000 K	N ON/OFF	W White 05
		30 3000lm	MF MFL 22°-26°				
		40 4000lm	FL FL 33°-36°				
			WF WFL 56°-57°				
IM3	TK	20	SP	9	30	N	W





TECHNICAL CHARACTERISTICS

Optics

SP 15°-20°

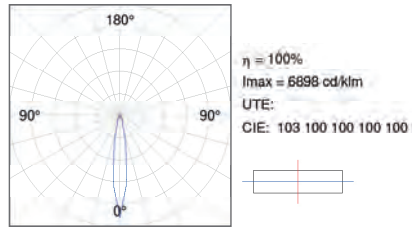

FL 22°-26°

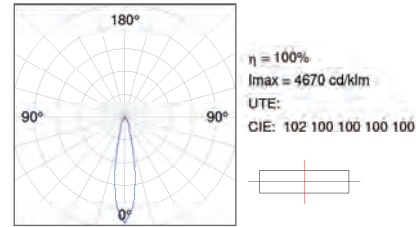

MFL 33°-36°

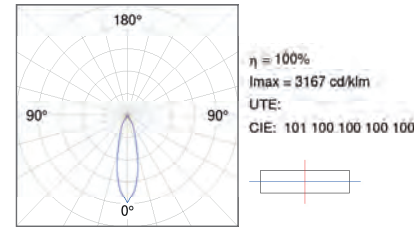

WFL 56°-57°

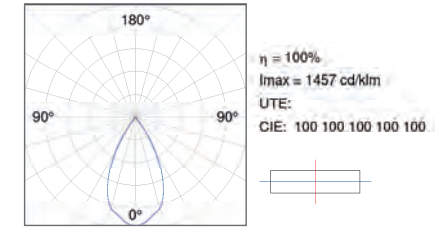

Light output and power

IMAG G3 TRACK

	K	CRI	2000lm		3000lm		4000lm	
			W	lm Output	W	lm Output	W	lm Output
SP 15°-20°	3000	90	16	1416	28,8	2303	42,3	3008
	4000	90	16	1509	28,8	2454	42,3	3205
FL 22°-26°	3000	90	16	1505	28,8	2449	42,3	3198
	4000	90	16	1604	28,8	2609	42,3	3408
MFL 33°-36°	3000	90	16	1469	28,8	2389	42,3	3121
	4000	90	16	1565	28,8	2546	42,3	3325
WFL 56°-57°	3000	90	16	1607	28,8	2615	42,3	3415
	4000	90	16	1712	28,8	2786	42,3	3639



ACCESSORIES

Adaptor mandatory to use accessories



Ref.	Color
ADDRD170B	●

Refractor for elliptical distribution of luminous flu

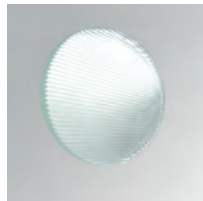

Ref.	ømm
ELRD150	95

Anti-glare honeycomb grille

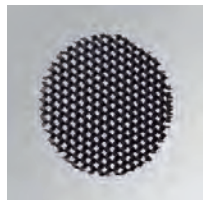

Ref.	Color
HORD150	●

Anti-glare screen

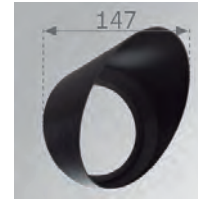

Ref.	Color
SCRD170B	●

Anti-glare louvres

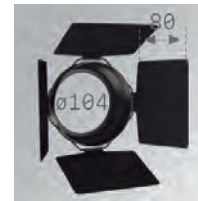

Ref.	Color	mm
LORD170B	●	L 112

Buffer



Ref.	Color
CURD95B	●



Kombic Downlight



BASIC Kombic Downlight 70 Round Opal (54°)



COMFORT Kombic Downlight 70 Round Optic (50°)



EFFICIENCY Kombic Downlight 70 Round Reflector

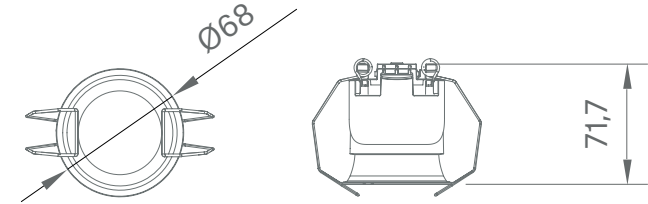

KOMBIC DOWNLIGHT 70 OPAL

Family	Lm LED	IP	Optic	CRI	K	Gear	Reflector Finishes	Ext. Finishes
K71	15 1500lm	44 IP 44	OP Opal 54°	9 90 8 80	27 2700 K 30 3000 K 40 4000 K	N ON/OFF D DALI	W White	W White 02
K71	15	44	OP	9	30	N	W	W

KOMBIC DOWNLIGHT 70 OPTIC

Family	Lm LED	IP	Optic	CRI	K	Gear	Reflector Finishes	Ext. Finishes
K71	15 1500lm	23 IP 23	WF Optic 52° EL Elliptic WW WallWasher	9 90 8 80	27 2700 K 30 3000 K 40 4000 K	N ON/OFF D DALI	W White B Black	W White 02 B Black 02
K71	15	23	WF	9	30	N	W	W

KOMBIC DOWNLIGHT 70 REFLECTOR

Family	Lm LED	IP	Optic	CRI	K	Gear	Reflector Finishes	Ext. Finishes
K71	15 1500lm	23 IP 23	RF Flood 33° RW Wide Flood 52°	9 90 8 80	27 2700 K 30 3000 K 40 4000 K	N ON/OFF D DALI	W White B Black	W White 02 B Black 02
K71	15	23	WF	9	30	N	W	W





BASIC

Kombic Downlight 70

Round Opal IP65 (54°)



KOMBIC DOWNLIGHT 70 OPAL

Family	Lm LED	IP	Optic	CRI	K	Gear	Reflector Finishes	Ext. Finishes
K71	15 1500lm	65 IP 65	OP Opal 54°	9 90 8 80	27 2700 K 30 3000 K 40 4000 K	N ON/OFF D DALI	W White	W White 02
K71	15	65	OP	9	30	N	W	W





OP 54°

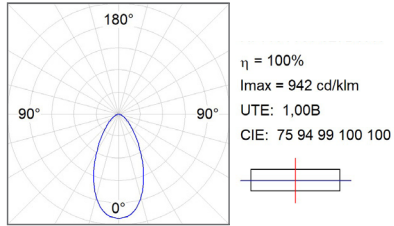

WFL 52°

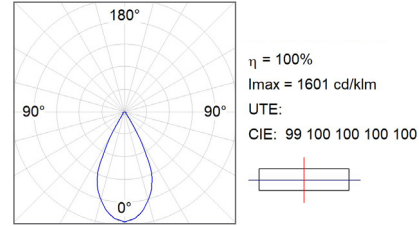

ELLIPTIC

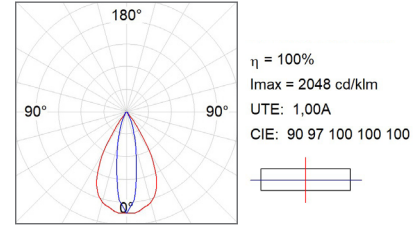

WALL WASHER (WW)

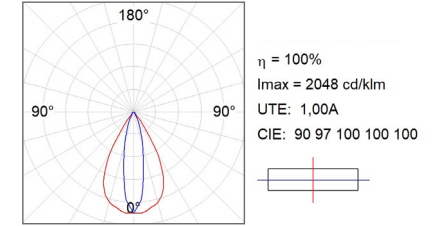

KOMBIC DOWNLIGHT 70 OPAL

	K	CRI	1500lm	
			W	lm Output
WH (54°)	2700	90	9,5	763
		80	9,5	892
	3000	90	9,5	916
		80	9,5	935
4000	90	9,5	849	
	80	9,5	981	

KOMBIC DOWNLIGHT 70 WF

	K	CRI	1500lm	
			W	lm Output
WH	2700	90	10	695
		80	10	821
	3000	90	10	732
		80	10	855
	4000	90	10	772
		80	10	905
BK	2700	90	10	515
		80	10	515
	3000	90	10	543
		80	10	543
	4000	90	10	572
		80	10	572

KOMBIC DOWNLIGHT 70 ELLIPTIC

	K	CRI	1500lm	
			W	lm Output
WH	2700	90	9,5	723
		80	9,5	847
	3000	90	9,5	756
		80	9,5	888
4000	90	9,5	806	
	80	9,5	932	
BK	2700	90	9,5	657
		80	9,5	768
	3000	90	9,5	686
		80	9,5	805
	4000	90	9,5	731
		80	9,5	845

KOMBIC DOWNLIGHT 70 WALL WASHER

	K	CRI	1500lm	
			W	lm Output
WH	2700	90	9,5	847
		80	9,5	723
	3000	90	9,5	888
		80	9,5	756
4000	90	9,5	932	
	80	9,5	806	
BK	2700	90	9,5	768
		80	9,5	657
	3000	90	9,5	805
		80	9,5	686
	4000	90	9,5	845
		80	9,5	731



FL 33°

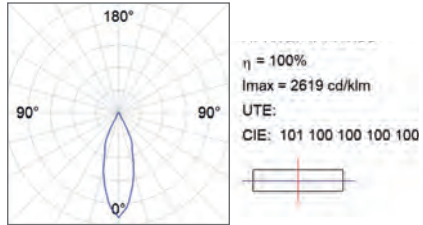

WFL 52°

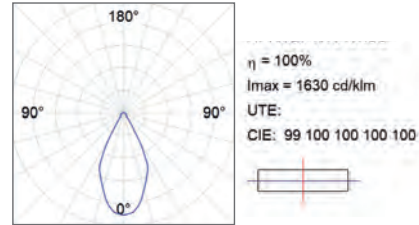

KOMBIC DOWNLIGHT 70 REFLECTOR

		1500lm			
		K	CRI	W	lm Output
FL (33°)	WH	2700	90	9,5	959
			80	9,5	1120
	3000	90	9,5	1000	
		80	9,5	1174	
	4000	90	9,5	1066	
		80	9,5	1232	
BK	2700	90	9,5	840	
		80	9,5	981	
	3000	90	9,5	876	
		80	9,5	1029	
	4000	90	9,5	934	
		80	9,5	1080	

		1500lm			
		K	CRI	W	lm Output
WFL (52°)	WH	2700	90	9,5	901
			80	9,5	1053
	3000	90	9,5	940	
		80	9,5	1104	
	4000	90	9,5	1002	
		80	9,5	1158	
BK	2700	90	9,5	730	
		80	9,5	854	
	3000	90	9,5	762	
		80	9,5	895	
	4000	90	9,5	813	
		80	9,5	939	



BASIC Kombic Downlight 100 Round Opal

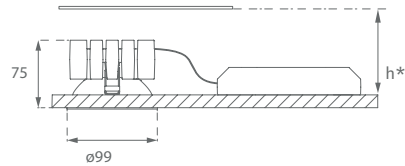

* See height (h) in the instruction sheet.

BASIC Kombic Downlight 100 Square Opal

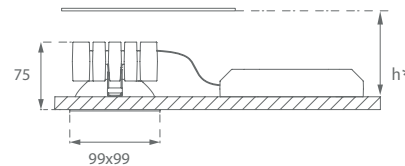

* See height (h) in the instruction sheet.

BASIC Kombic Downlight 100 Opal IP65

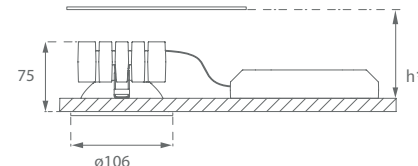

* See height (h) in the instruction sheet.

KOMBIC DOWNLIGHT 100 OPAL

Family	Installation	Lm LED	IP	Optic	CRI	K	Gear	Reflector Finishes	Ext. Finishes
K11	RD Round	15 1500lm	40 IP 43	OP Opal	9 90	27 2700 K	N ON/OFF	R Bright	W White 02
		20 2000lm							
	SQ Square	20 2000lm	40 IP 43	OP Opal	8 80	30 3000 K	D DALI	M Metalized Matt	W White
		25 2500lm							
K11	RD Round	20 2000lm	65 IP 65	OP Opal	8 80	30 3000 K	N ON/OFF	W White	W White 02
		25 2500lm							
K11	RD	15	40	OP	9	30	N	R	W



Kombic Downlight | Indoor

FAMILY PRESENTATION

Ind.



BASIC Kombic Downlight 100 Round Opal

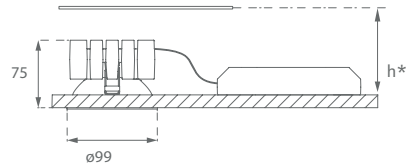

BASIC Kombic Downlight 100 Square Opal

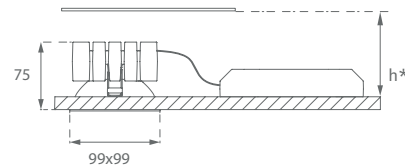

* See height (h) in the instruction sheet.

WB

KOMBIC DOWNLIGHT 100 OPAL WELLBEING

Family	Installation	Lm LED	IP	Optic	K	Gear	Reflector Finishes	Ext. Finishes
K11	RD Round	15 1500lm	40 IP 43	OP Opal	WB3 3000 WB WB4 4000 WB	N ON/OFF D DALI	R Bright M Metalized Matt W White	W White 02
	SQ Square	20 2000lm						
K11	RD	15	40	OP	WB3	N	R	W

KOMBIC DOWNLIGHT 100 OPAL TW

Family	Installation	Lm LED	IP	Optic	CRI	K	Gear	Reflector Finishes	Ext. Finishes
K11	RD Round	20 2000lm	40 IP 43	OP Opal	9 90	TW Tunnable White	D DALI	R Bright M Metalized Matt W White	W White 02
	SQ Square								
K11	RD	20	40	OP	9	TW	D	R	W



Kombic Downlight | Indoor

FAMILY PRESENTATION

Ind.



COMFORT Kombic Downlight 100 Round Optic

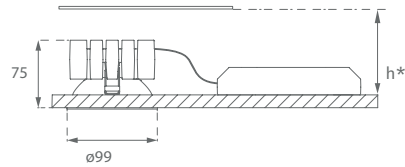

* See height (h) in the instruction sheet.

COMFORT Kombic Downlight 100 Square Optic

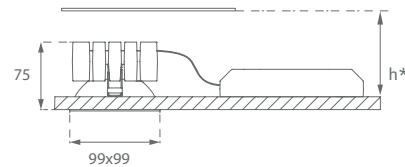

* See height (h) in the instruction sheet.

KOMBIC DOWNLIGHT 100 OPTIC

Family	Installation	Lm LED	IP	Optic	CRI	K	Gear	Reflector Finishes	Ext. Finishes
K11	RD Round SQ Square	15 1500lm	40 IP 43	WF WFL 50°	9	90	N ON/OFF D DALI	B Black M Metalized Matt W White	B Black O2 W White O2
				43 IP 43 WW Wallwasher EL Elliptic					
	20 2000lm	40 IP 43	WF WFL 50°	8	80 9 90				
			43 IP 43 WW Wallwasher EL Elliptic						
	25 2500lm	40 IP 43	WF WFL 50°	8	80				
			43 IP 43 WW Wallwasher EL Elliptic						

K11 RD 15 40 WF 9 27 N B B



Kombic Downlight | Indoor

FAMILY PRESENTATION



COMFORT Kombic Downlight 100 Round Optic

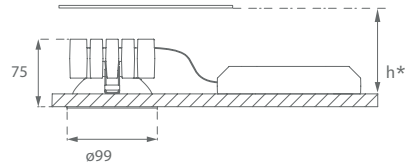

COMFORT Kombic Downlight 100 Square Optic

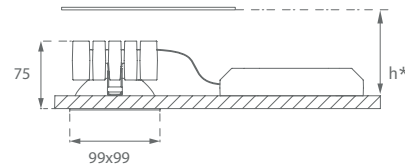

* See height (h) in the instruction sheet.

WB

KOMBIC DOWNLIGHT 100 OPTIC WELLBEING

Family	Installation	Lm LED	IP	Optic	K	Gear	Reflector Finishes	Ext. Finishes
K11	RD Round	15 1500lm	40 IP 43	WF WFL 50°	WB3 3000 WB WB4 4000 WB	N ON/OFF D DALI	B Black M Metalized Matt W White	B Black 02 W White 02
	SQ Square	20 2000lm						
K11	RD	15	40	WF	WB3	N	B	W

KOMBIC DOWNLIGHT 100 OPTIC TW

Family	Installation	Lm LED	IP	Optic	CRI	K	Gear	Reflector Finishes	Ext. Finishes
K11	RD Round	20 2000lm	40 IP 43	WF WFL 50°	9 90	TW Tunable White	D DALI	B Black M Metalized Matt W White	B Black 02 W White 02
	SQ Square								
			43 IP 43	WW Wallwasher					
K11	RD	20	40	WF	9	TW	D	B	B



Kombic Downlight | Indoor

FAMILY PRESENTATION



COMFORT Kombic Downlight 100 Round Orientable

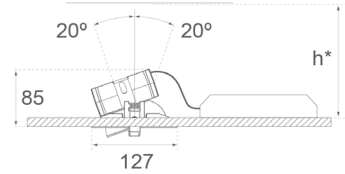

EFFICIENCY Kombic Downlight 100 Reflector

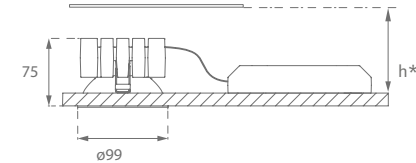

* See height (h) in the instruction sheet.

KOMBIC DOWNLIGHT 100 ROUND ORIENTABLE

Family	Installation	Lm LED	IP	Optic	CRI	K	Gear	Reflector Finishes	Ext. Finishes
K11	R0 Round Orientable	15 1500lm	40 IP 43	WF Wide Flood	9 90	27 2700 K	N ON/OFF D DALI	B Black W White	B Black O2 W White O2
		20 2000lm				30 3000 K			
		20 2500lm				40 4000 K			
K11	R0	15	40	WF	9	27	N	B	B
		20				30			
		25				40			

KOMBIC DOWNLIGHT 100 REFLECTOR

Family	Installation	Lm LED	IP	Optic	CRI	K	Gear	Reflector Finishes	Ext. Finishes
K11	RD Round	15 1500lm	23 IP 23	RF Flood RW Wide Flood	9 90	27 2700 K	N ON/OFF D DALI	B Black M Metalized Matt W White	B Black O2 W White O2
		20 2000lm				30 3000 K			
		25 2500lm				40 4000 K			
K11	RD	15	23	RF	9	27	N	B	B
		20				30			
		25				40			





TECHNICAL CHARACTERISTICS

Optics

OP

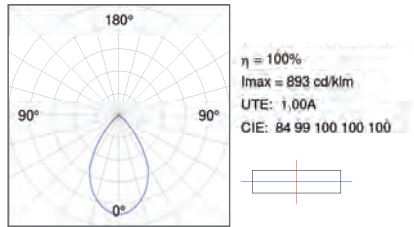

Light output and power

KOMBIC DOWNLIGHT 100 OPAL

	K	CRI	1500lm		2000lm		2500lm	
			W	lm Output	W	lm Output	W	lm Output
BK	2700	90	13,7	1191	-	1598	-	-
		80	13,7	-	-	-	-	-
	3000	90	13,7	1230	20,4	1648	-	-
		80	13,7	-	14,8	1460	21,6	1951
	4000	90	13,7	1336	-	1793	-	-
		80	13,7	-	14,8	1547	21,6	2067
MA	2700	90	13,7	1135	-	1523	-	-
		80	13,7	-	-	-	-	-
	3000	90	13,7	1172	-	1571	-	-
		80	13,7	-	14,8	1392	21,6	1951
	4000	80	13,7	1273	19,1	1708	-	-
		90	13,7	-	14,8	1474	21,6	2067
WH	2700	90	13,7	1186	19,1	1591	-	-
		80	13,7	-	-	-	-	-
	3000	90	13,7	1125	19,1	1642	-	-
		80	13,7	-	14,8	1454	21,6	1951
	4000	90	13,7	1330	19,1	1785	-	-
		80	13,7	-	14,8	1541	21,6	2067

KOMBIC DOWNLIGHT 100 OPAL WELLBEING

	K	CRI	1200lm		1800lm	
			W	lm Output	W	lm Output
MA	3000	95	13,9	929	20	1243
		4000	95	13,9	986	20
BR	3000	95	13,9	971	20	1316
		4000	95	13,9	1031	20
WH	3000	95	13,9	951	20	1206
		4000	95	13,9	1035	20



TECHNICAL CHARACTERISTICS

Light output and power

WFL 50°

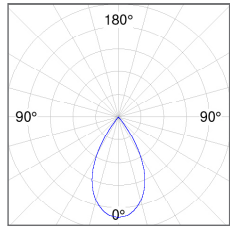

η = 100%
lmax = 1327 cd/klm
UTE:
CIE: 99 100 100 100 100



KOMBIC DOWNLIGHT 100 OPTIC WIDE FLOOD (WF)

	K	CRI	1500lm		2000lm		2500lm	
			W	lm Output	W	lm Output	W	lm Output
BK	2700	90	13,4	983	-	-	-	-
		80	-	-	-	-	21,6	1609
	3000	90	13,4	1015	20,4	1354	-	-
		80	-	-	14,8	1205	21,6	1609
4000	90	13,4	1102	-	-	-	-	
	80	-	-	14,8	1277	21,6	1704	
MA	2700	90	13,4	1030	19,1	1380	-	-
		80	-	-	-	-	-	-
	3000	90	13,4	1068	19,1	1424	-	-
		80	-	-	13,7	1268	19,8	1692
4000	90	13,4	1160	19,1	1548	-	-	
	80	-	-	13,7	1343	19,8	1792	
WH	2700	90	13,4	1040	19,1	1387	-	-
		80	-	-	-	-	-	-
	3000	90	13,4	1074	19,1	1432	-	-
		80	-	-	13,7	1275	19,8	1701
4000	90	13,4	1166	19,1	1556	-	-	
	80	-	-	13,7	1351	19,8	1802	

KOMBIC DOWNLIGHT 100 OPTIC WALL WASHER (WW)

	K	CRI	1500lm		2000lm		2500lm	
			W	lm Output	W	lm Output	W	lm Output
BK	2700	90	13,7	901	19,8	1209	-	-
		80	-	-	-	-	-	-
	3000	90	13,7	940	19,8	1262	-	-
		80	13,7	1159	13,7	1159	19,8	1555
4000	90	13,7	1003	19,8	1346	-	-	
	80	13,7	1216	13,7	1216	19,8	1632	
MA	2700	90	13,7	1210	19,8	1633	-	-
		80	-	-	-	-	-	-
	3000	90	13,7	1263	19,8	1703	-	-
		80	13,7	1556	13,7	1556	19,8	2099
4000	90	13,7	1346	19,8	1816	-	-	
	80	13,7	1633	13,7	1633	19,8	2203	
WH	2700	90	13,7	1210	19,8	1633	-	-
		80	-	-	-	-	-	-
	3000	90	13,7	1263	19,8	1703	-	-
		80	13,7	1556	13,7	1556	19,8	2099
4000	90	13,7	1346	19,8	1816	-	-	
	80	13,7	1633	13,7	1633	19,8	2203	

KOMBIC DOWNLIGHT 100 OPTIC WELLBEING WIDE FLOOD (WF)

	K	CRI	1200lm		1800lm	
			W	lm Output	W	lm Output
BK	3000	95	13,9	835	20	1109
		4000	95	13,9	885	20
MA	3000	95	13,9	862	20	1185
		4000	95	13,9	914	20
WH	3000	95	13,9	857	20	1057
		4000	95	13,9	947	20



TECHNICAL CHARACTERISTICS

Light output and power

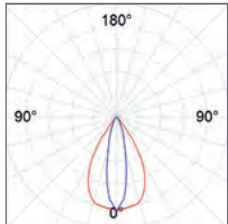

$\eta = 101\%$
 $I_{max} = 1940 \text{ cd/klm}$
 UTE: 1,01A
 CIE: 92 99 100 100 101



KOMBIC DOWNLIGHT 100 OPTIC ELLIPTIC

	K	CRI	1500lm		2000lm	
			W	lm Output	W	lm Output
BK	2700	90	13,7	1163	19,8	1563
		80	13,7	-	19,8	-
	3000	90	13,7	1213	19,8	1631
		80	13,7	1425	19,8	1915
	4000	90	13,7	1294	19,8	1739
		80	13,7	1495	19,8	2010
MA	2700	90	13,7	1239	19,8	1665
		80	13,7	-	19,8	-
	3000	90	13,7	1293	19,8	1737
		80	13,7	1518	19,8	2040
	4000	90	13,7	1378	19,8	1853
		80	13,7	1593	19,8	2141
WH	2700	90	13,7	1239	19,8	1665
		80	13,7	-	19,8	-
	3000	90	13,7	1293	19,8	1737
		80	13,7	1518	19,8	2040
	4000	90	13,7	1378	19,8	1853
		80	13,7	1593	19,8	2141



TECHNICAL CHARACTERISTICS

Light output and power

KOMBIC DOWNLIGHT 100 REFLECTOR WF

				1500lm		2000lm		2500lm	
		K	CRI	W	lm Output	W	lm Output	W	lm Output
WF	BK	2700	90	14,5	1168	19,8	1711	-	-
			80	-	-	-	-	-	-
		3000	90	14,5	1218	19,8	1785	-	-
			80	-	-	14,5	1549	19,8	1908
		4000	90	14,5	1299	19,8	1903	-	-
			80	-	-	14,5	1226	19,8	2002
MA	2700	90	14,5	1264	19,8	1815	-	-	
			80	-	-	-	-	-	-
		3000	90	14,5	1318	19,8	1893	-	-
			80	-	-	14,5	1538	19,8	2081
		4000	90	14,5	1406	19,8	2019	-	-
			80	-	-	14,5	1692	19,8	2184
WH	2700	90	14,5	1264	19,8	1815	-	-	
			80	-	-	-	-	-	-
		3000	90	14,5	1318	19,8	1893	-	-
			80	-	-	14,5	1612	19,8	2081
		4000	90	14,5	1406	19,8	2019	-	-
			80	-	-	14,5	1692	19,8	2184

KOMBIC DOWNLIGHT 100 REFLECTOR FL

				1500lm		2000lm		2500lm	
		K	CRI	W	lm Output	W	lm Output	W	lm Output
FL	BK	2700	90	14,5	1273	21,6	1711	-	-
			80	-	-	-	-	-	-
		3000	90	14,5	1328	21,6	1785	-	-
			80	-	-	14,1	1549	19,8	2082
		4000	90	14,5	1416	21,6	1903	-	-
			80	-	-	14,1	1226	19,8	2185
MA	2700	90	14,5	1325	21,6	1815	-	-	
			80	-	-	-	-	-	-
		3000	90	14,5	1382	21,6	1893	-	-
			80	-	-	14,1	1612	19,8	2208
		4000	90	14,5	1474	21,6	2019	-	-
			80	-	-	14,1	1692	19,8	2318
WH	2700	90	14,5	1325	21,6	1815	-	-	
			80	-	-	-	-	-	-
		3000	90	14,5	1382	21,6	1893	-	-
			80	-	-	14,1	1612	19,8	2208
		4000	90	14,5	1474	21,6	2019	-	-
			80	-	-	14,1	1692	19,8	2318

Kombic Downlight | Indoor

BASIC Kombic Downlight 150 Opal

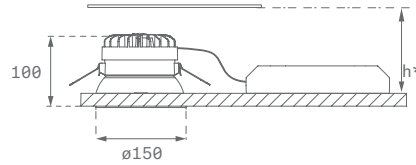

* See height (h) in the instruction sheet.

BASIC Kombic Downlight 150 Opal IP65

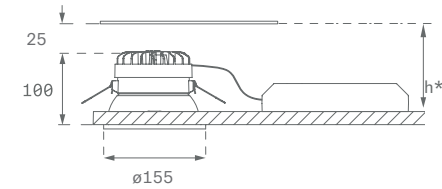

* See height (h) in the instruction sheet.

FAMILY PRESENTATION

Ind.



KOMBIC DOWNLIGHT 150 OPAL

Family	Installation	Lm LED	IP	Optic	CRI	K	Gear	Reflector Finishes	Ext. Finishes
K21	RD Round	20 2000lm	40 IP 43	OP Opal	9 90	27 2700 K	N ON/OFF	R Bright	W White 02
		30 3000lm							
		40 4000 K							
	RD Round	20 2000lm	65 IP 65	OP Opal	8 80	30 3000 K	N ON/OFF	W White	W White 02
		30 3000lm							
		40 4000 K							
K21	RD	20	40	OP	9	27	N	R	W
		30							
		35							



Kombic Downlight | Indoor

FAMILY PRESENTATION



BASIC Kombic Downlight 150 Opal

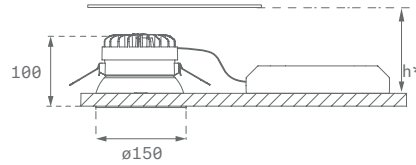

* See height (h) in the instruction sheet.

WB

KOMBIC DOWNLIGHT 150 OPAL WELLBEING

Family	Installation	Lm LED	IP	Optic	K	Gear	Reflector Finishes	Ext. Finishes
K21	RD Round	20 2000lm 25 2500lm	40 IP 43	OP Opal	WB3 3000 WB WB4 4000 WB	N ON/OFF D DALI	R Bright M Metalized Matt W White	W White 02
K21	RD	20	40	OP	WB3	N	R	W

KOMBIC DOWNLIGHT 150 OPAL TW

Family	Installation	Lm LED	IP	Optic	CRI	K	Gear	Reflector Finishes	Ext. Finishes
K21	RD Round	30 3000lm	40 IP 43	OP Opal	9 90	TW Tunnable White	D DALI	R Bright M Metalized Matt W White	W White 02
K21	RD	30	40	OP	9	TW	D	R	W





COMFORT Kombic Downlight 150 Optic

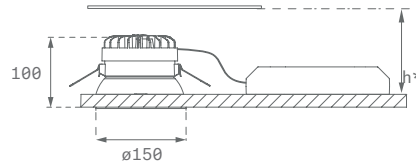

* See height (h) in the instruction sheet.

KOMBIC DOWNLIGHT 150 OPTIC

Family	Installation	Lm LED	IP	Optic	CRI	K	Gear	Reflector Finishes	Ext. Finishes
K21	RD Round	20 2000lm	40 IP 43	WF WFL 50°	9 90	27 2700 K	N ON/OFF D DALI	B Black	B Black 02 W White 02
		30 3000lm		WW WallWasher EL Elliptic					
K21	RD	20	40	WF WFL 50°	8 80	30 3000 K 40 4000 K	N	M Metalized Matt W White	W White 02
				WW WallWasher EL Elliptic					
				WF					

KOMBIC DOWNLIGHT 150 OPTIC WELLBEING WB

Family	Installation	Lm LED	IP	Optic	K	Gear	Reflector Finishes	Ext. Finishes
K21	RD Round	20 2000lm	40 IP 43	WF WFL 50°	WB3 3000 WB	N ON/OFF D DALI	B Black	B Black W White 02
		25 2500lm			WB4 4000 WB			
K21	RD	20	40	WF	WB3	N	B	B

KOMBIC DOWNLIGHT 150 OPTIC TW

Family	Installation	Lm LED	IP	Optic	CRI	K	Gear	Reflector Finishes	Ext. Finishes
K21	RD Round	30 3000lm	40 IP 43	WF WFL 50°	9 90	TW Tunnable White	D DALI	B Black	B Black W White 02
									M Metalized Matt W White
K21	RD	30	40	WF	9	TW	D	B	B



Kombic Downlight | Indoor

EFFICIENCY

Kombic Downlight 150

Round Reflector

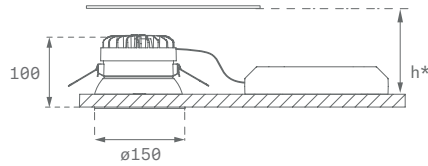

* See height (h) in the instruction sheet.

FAMILY PRESENTATION

Ind.



KOMBIC DOWNLIGHT 150 REFLECTOR

Family	Installation	Lm LED	IP	Optic	CRI	K	Gear	Reflector Finishes	Ext. Finishes
K21	RD Round	20 2000lm 30 3000lm	23 IP 23	RF Flood	9 90	27 2700 K 30 3000 K 40 4000 K	N ON/OFF D DALI	B Black	B Black 02
				RW Wide Flood					W White 02
		20 2000lm 30 3000lm 35 3500lm	23 IP 23	RF Flood	8 80	30 3000 K 40 4000 K	M Metalized Matt W White	W White 02	
				RW Wide Flood					
		K21	RD	20	23	RF	9	27	N





TECHNICAL CHARACTERISTICS

Optics

OP

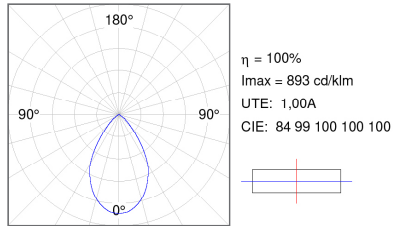

WFL 50°

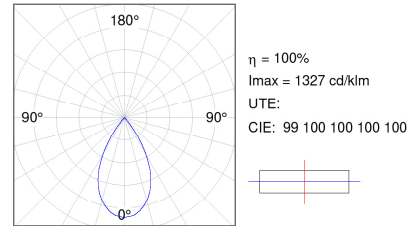

Light output and power

KOMBIC DOWNLIGHT 150 OPAL

	K	CRI	2000lm		3000lm		3500lm	
			W	lm Output	W	lm Output	W	lm Output
BR	2700	90	19,8	1675	27,7	2227	-	-
		80	-	-	-	-	-	-
	3000	90	19,8	1739	27,7	2312	-	-
		80	13,4	1488	19,9	2096	27,7	2788
	4000	90	19,8	1874	27,7	2492	-	-
		80	13,4	1550	19,9	2184	27,7	2904
MA	2700	90	19,8	1606	27,7	2135	-	-
		80	-	-	-	-	-	-
	3000	90	19,8	1667	27,7	2216	-	-
		80	13,4	1427	19,9	2010	27,7	2673
	4000	90	19,8	1797	27,7	2389	-	-
		80	13,4	1486	19,9	2094	27,7	2784
WH	2700	90	19,8	1658	27,7	2203	-	-
		80	-	-	-	-	-	-
	3000	90	19,8	1720	27,7	2288	-	-
		80	13,4	1473	19,9	2074	27,7	2759
	4000	90	19,8	1854	27,7	2466	-	-
		80	13,4	1534	19,9	2161	27,7	2874

KOMBIC DOWNLIGHT 150 OPTIC WIDE FLOOD

	K	CRI	2000lm		3000lm		3500lm	
			W	lm Output	W	lm Output	W	lm Output
BK	2700	90	19,8	1289	27,7	1713	-	-
		80	-	-	-	-	-	-
	3000	90	19,8	1338	27,7	1779	-	-
		80	13,4	1145	19,9	1613	27,7	2145
	4000	90	19,8	1442	27,7	1917	-	-
		80	13,4	1193	19,9	1680	27,7	2235
MA	2700	90	19,8	1293	27,7	1718	-	-
		80	-	-	-	-	-	-
	3000	90	19,8	1342	27,7	1784	-	-
		80	13,4	1148	19,9	1618	27,7	2151
	4000	90	19,8	1446	27,7	1923	-	-
		80	13,4	1196	19,9	1685	27,7	2241
WH	2700	90	19,8	1332	27,7	1771	-	-
		80	-	-	-	-	-	-
	3000	90	19,8	1383	27,7	1838	-	-
		80	13,4	1184	19,9	1677	27,7	2217
	4000	90	19,8	1490	27,7	1982	-	-
		80	13,4	1233	19,9	1737	27,7	2310



TECHNICAL CHARACTERISTICS

Light output and power

KOMBIC DOWNLIGHT 150 OPAL WELLBEING

	K	CRI	2000lm		2500lm	
			W	lm Output	W	lm Output
BK	3000	95	19	1368	27,4	1932
	4000	95	19	1491	27,4	2190
MA	3000	95	19	1308	27,4	1884
	4000	95	19	1429	27,4	2075
WH	3000	95	19	1361	27,4	1951
	4000	95	19	1474	27,4	2170

KOMBIC DOWNLIGHT 150 OPTIC WELLBEING WIDE FLOOD

	K	CRI	2000lm		2500lm	
			W	lm Output	W	lm Output
BK	3000	95	19	1192	27,4	1543
	4000	95	19	1297	27,4	1652
MA	3000	95	19	1205	27,4	1567
	4000	95	19	1321	27,4	1713
WH	3000	95	19	1208	27,4	1596
	4000	95	19	1335	27,4	1711

KOMBIC DOWNLIGHT 150 OPTIC ELLIPTIC

	K	CRI	2000lm		3000lm		3500lm	
			W	lm Output	W	lm Output	W	lm Output
BR	2700	90	19,4	1725	27,7	2275	-	-
		80	-	-	-	-	-	-
	3000	90	19,4	1815	27,7	2395	-	-
		80	13,4	1555	19,4	2125	27,7	2805
	4000	90	19,4	1915	27,7	2525	-	-
		80	13,4	1645	19,9	2250	27,7	2965
WH	2700	90	19,4	1815	27,7	2395	-	-
		80	-	-	-	-	-	-
	3000	90	19,4	1910	27,7	2520	-	-
		80	13,4	1640	19,4	2240	27,7	2955
	4000	90	19,4	2020	27,7	2670	-	-
		80	13,4	1730	19,4	2370	27,7	3125

KOMBIC DOWNLIGHT 150 OPTIC WALLWASHER

	K	CRI	2000lm		3000lm		3500lm	
			W	lm Output	W	lm Output	W	lm Output
BK	2700	90	19,4	1195	27,7	1575	-	-
		80	-	-	-	-	-	-
	3000	90	19,4	1260	27,7	1660	-	-
		80	13,4	1080	19,4	1475	27,7	1945
	4000	90	19,4	1330	27,7	1750	-	-
		80	13,4	1140	19,9	1560	27,7	2055
WH	2700	90	19,4	1470	27,7	1940	-	-
		80	-	-	-	-	-	-
	3000	90	19,4	1550	27,7	2040	-	-
		80	13,4	1330	19,4	1815	27,7	2395
	4000	90	19,4	1635	27,7	2155	-	-
		80	13,4	1405	19,4	1920	27,7	2530



TECHNICAL CHARACTERISTICS

Light output and power

FL 30°

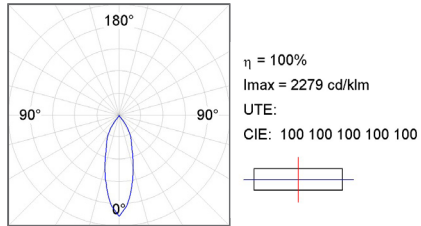

WFL 55°

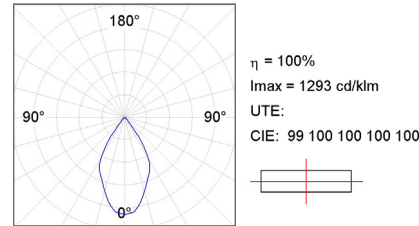

KOMBIC DOWNLIGHT 150 REFLECTOR FLOOD (30°)

	K	CRI	2000lm		3000lm		3500lm	
			W	lm Output	W	lm Output	W	lm Output
BK	2700	90	19,1	1992	28,3	2622	-	-
		80	13,9	-	19,1	-	-	-
	3000	90	19,1	2089	28,3	2749	-	-
		80	13,9	1835	19,1	2448	28,3	3223
	4000	90	19,1	2225	28,3	2929	-	-
		80	13,1	1927	19,1	2570	28,3	3383
MA	2700	90	19,1	1945	28,3	2560	-	-
		80	13,9	-	19,1	-	-	-
	3000	90	19,1	2039	28,3	2684	-	-
		80	13,9	1792	19,1	2390	28,3	3146
	4000	90	19,1	2172	28,3	2962	-	-
		80	13,1	1881	19,1	2509	28,3	3303
WH	2700	90	19,1	1945	28,3	2560	-	-
		80	13,9	-	19,1	-	-	-
	3000	90	19,1	2039	28,3	2684	-	-
		80	13,9	1792	19,1	2390	28,3	3146
	4000	90	19,1	2172	28,3	2860	-	-
		80	13,1	1881	19,1	2509	28,3	3303

KOMBIC DOWNLIGHT 150 REFLECTOR WIDE FLOOD (55°)

	K	CRI	1500lm		2000lm		2500lm	
			W	lm Output	W	lm Output	W	lm Output
BK	2700	90	19,1	2002	28,3	2635	-	-
		80	-	-	-	-	-	-
	3000	90	19,1	2099	28,3	2763	-	-
		80	13,9	1844	19,1	2460	28,3	3239
	4000	90	19,1	2236	28,3	2944	-	-
		80	13,1	1936	19,1	2583	28,3	3400
MA	2700	90	19,1	2014	28,3	2651	-	-
		80	-	-	-	-	-	-
	3000	90	19,1	2112	28,3	2780	-	-
		80	13,9	1854	19,1	2475	28,3	3259
	4000	90	19,1	2250	28,3	2962	-	-
		80	13,1	1948	19,1	2598	28,3	3420
WH	2700	90	19,1	2014	28,3	2651	-	-
		80	-	-	-	-	-	-
	3000	90	19,1	2112	28,3	2780	-	-
		80	13,9	1854	19,1	2475	28,3	3259
	4000	90	19,1	2250	28,3	2962	-	-
		80	13,1	1948	19,1	2598	28,3	3420

Kombic Downlight | Indoor

BASIC Kombic Downlight 200 Opal

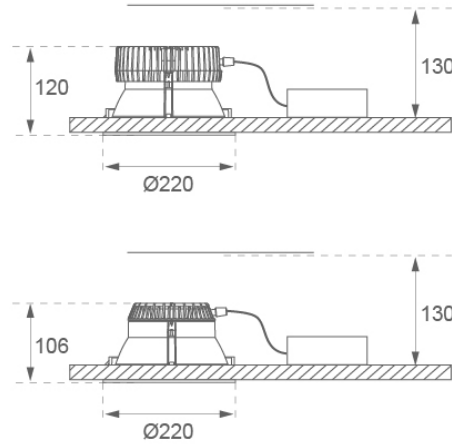

FAMILY PRESENTATION

Ind.



BASIC Kombic Downlight 200 Square Opal

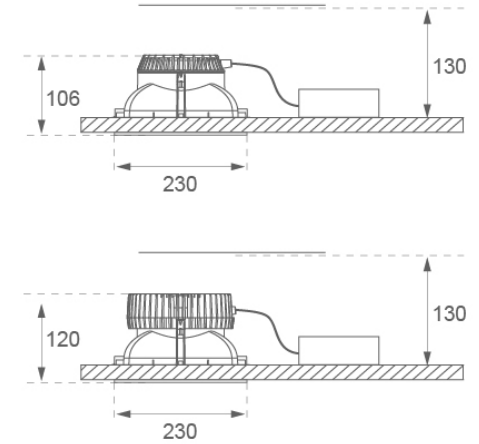

KOMBIC DOWNLIGHT 200 OPAL

Family	Installation	Lm LED	IP	Optic	CRI	K	Gear	Reflector Finishes	Ext. Finishes
K32	RD Round	30	3000lm	40 IP 44	OP Opal	8 80	N ON/OFF D DALI	R Bright M Matt W White Lexan	W White
		40	4000lm						
		50	5000lm						
		70	7000lm						
	SQ Square	30	4000lm	40 IP 44	OP Opal	8 80	N ON/OFF D DALI	R Bright W White Lexan	W White
		50	5000lm						
	70	7000lm							
	RD Round	20	2000lm	40 IP 44	OP Opal	9 90	D DALI	R Bright	W White
	SQ Square	30	3000lm					M Matt	
K32	RD	30	40	OP	8	30	N	R	W





TECHNICAL CHARACTERISTICS

Optics

RD OPAL BRIGHT

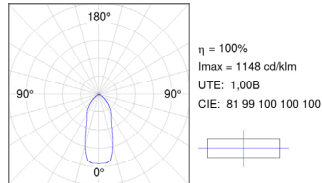

RD OPAL MATT

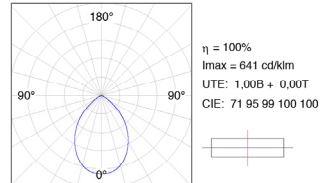

SQ OPAL BRIGHT

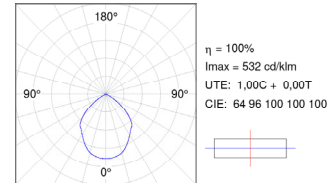

RD WHITE OPAL

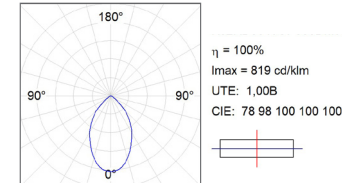

SQ OPAL OPAL

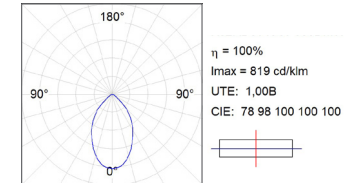

Light output and power

KOMBIC 200 RD

	K	CRI	3000lm		4000lm		5000lm		7000lm	
			W	lm Output	W	lm Output	W	lm Output	W	lm Output
BR	3000	80	16,7	2181	24,1	3025	34	3977	51	5789
	4000	80	16,7	2304	24,1	3195	34	4201	51	5840
MA	3000	80	16,7	2138	24,1	2966	34	3899	51	5373
	4000	80	16,7	2259	24,1	3133	34	4119	51	5676
WH	3000	80	16,7	2138	24,1	2966	34	3899	51	5373
		80	16,7	2318	24,1	3214	34	4226	51	5823

KOMBIC 200 TW

	K	CRI	2000lm		3000lm	
			W	lm Output	W	lm Output
BR	TW	90	15,5	1506	22,4	2161
MA	TW	90	15,5	1355	22,4	1989

KOMBIC 200 SQ

	K	CRI	3000lm		4000lm		5000lm		7000lm	
			W	lm Output	W	lm Output	W	lm Output	W	lm Output
BR	3000	80	16,7	2181	24,1	3025	34	3977	51	5789
	4000	80	16,7	2304	24,1	3195	34	4201	51	5840
MA	3000	80	16,7	2138	24,1	2966	34	3899	51	5373
	4000	80	16,7	2259	24,1	3133	34	4119	51	5676
WH	3000	80	16,7	2138	24,1	2966	34	3899	51	5373
		80	16,7	2318	24,1	3214	34	4226	51	5823



ACCESSORIES

Decorative ring



Ref.

RIRD240W
RIRD240G
RIRD240B

Color



Transparent diffuser



Ref.

DITRRD240W
DITRRD240G
DITRRD240B

Color



Ø250 mm adapter ring



Ref.

ADRD250W

Color



ACCESSORIES SQUARE

Decorative frame

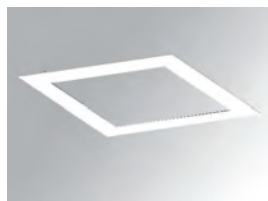

Ref.

FRSQ235W
FRSQ235B

Color



Transparent diffuser



Ref.

DITRSQ240W
DITRSQ240B

Color



Concrete recessing box



Ref.

BORE404



Kombic Surface

Kombic Surface 70
ON/OFF 1500

FAMILY PRESENTATION



Surface

OPAL



REFLECTOR FLOOD



WIDE FLOOD

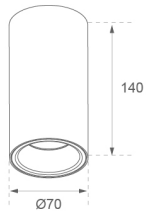

Track

OPAL



REFLECTOR FLOOD



WIDE FLOOD

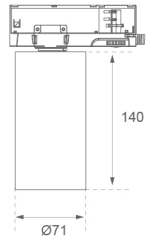

Short Track

OPAL



REFLECTOR FLOOD



WIDE FLOOD

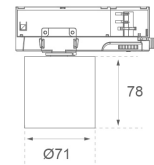

Susp. Track

OPAL



REFLECTOR FLOOD



WIDE FLOOD

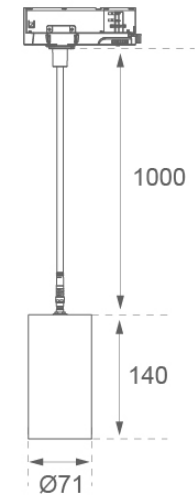

Kombic Surface 70
DALI 1500

FAMILY PRESENTATION



Surface

OPAL



REFLECTOR FLOOD



WIDE FLOOD

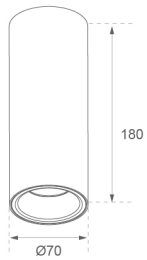

Track

OPAL



REFLECTOR FLOOD



WIDE FLOOD

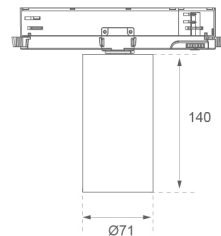

Short Track

OPAL



REFLECTOR FLOOD



WIDE FLOOD

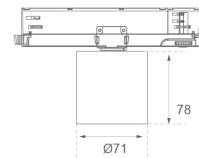

Susp. Track

OPAL



REFLECTOR FLOOD



WIDE FLOOD

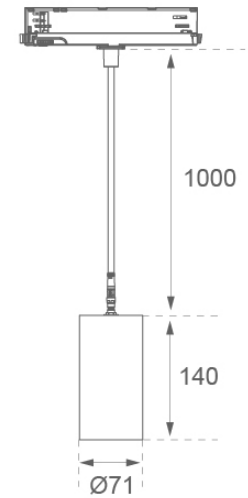

Kombic Surface 70 ON/OFF & DALI 1500

KOMBIC SURFACE 70

Family	Installation	Lm LED	IP	Optic	CRI	K	Gear	Ext. Finishes	
K71	SF Surface	15 1500lm	20 IP 23	RF Reflector Flood	8 80	27 2700 K	N ON/OFF	B Black	
	TK Track			RW Reflector Wide				9 90	30 3000 K
	ST Susp. Track			40 IP 43	OP Opal	8 80	27 2700 K	N ON/OFF	W White
	TS Track Short								9 90
				WF Wide Flood	8 80	27 2700 K	N ON/OFF	B Black	
					9 90	30 3000 K	D DALI	W White	
						40 4000 K		W White	
								B Black	
								W White	
K71	SF	15	20	OP	9	27	N	B	

ACCESSORIES

Rigid suspension for electrical connection



Ref.
[K71SUCAWI2000DBK](#)
[K71SUCAWI2000DWH](#)
[K71SUCAWI2000NBK](#)
[K71SUCAWI2000NWH](#)

Color

-
-
-
-

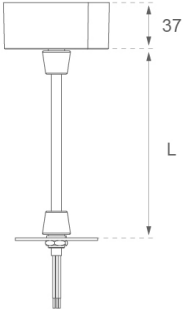

Cable grommets



Ref.
[K71SUADLATWH](#)
[K71SUADLATBK](#)

Color

-
-

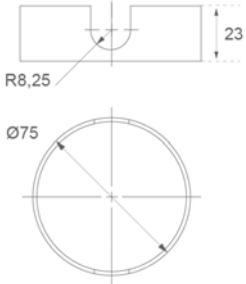



TECHNICAL CHARACTERISTICS

Optics

OP

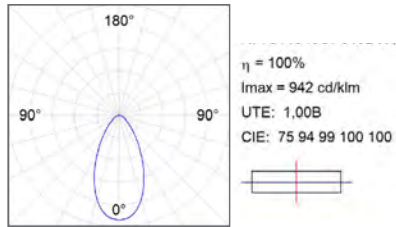

WF

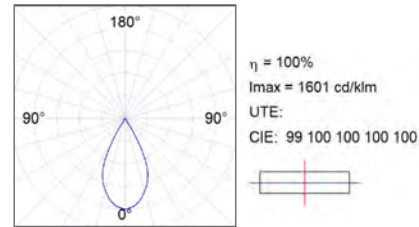

RW

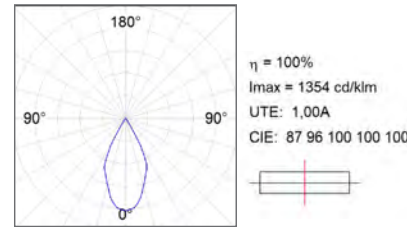

RF

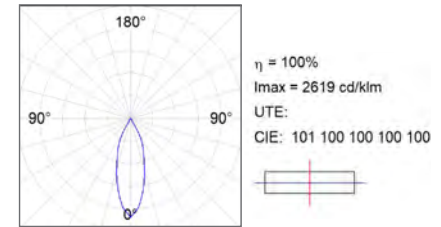

Light output and power

KOMBIC DOWNLIGHT 70 OPAL

		1500lm			
		K	CRI	W	lm Output
WH/ BK	2700	90	9,5	763	
		80	9,5	892	
	3000	90	9,5	916	
		80	9,5	935	
	4000	90	9,5	849	
		80	9,5	981	

KOMBIC DOWNLIGHT 70 OPTIC

		1500lm			
		K	CRI	W	lm Output
WH	2700	90	9,5	975	
		80	9,5	929	
	3000	90	9,5	829	
		80	9,5	973	
BK	4000	90	9,5	884	
		80	9,5	1022	
	2700	90	9,5	708	
		80	9,5	828	
	3000	90	9,5	739	
		80	9,5	868	
	4000	90	9,5	788	
		80	9,5	911	

KOMBIC DOWNLIGHT 70 REFLECTOR

		1500lm						1500lm			
		K	CRI	W	lm Output			K	CRI	W	lm Output
FL (33°)	WH	2700	90	9,5	959	WFL (52°)	WH	2700	90	9,5	901
			80	9,5	1120				80	9,5	1053
	3000	90	9,5	1000	3000	90	9,5	940			
		80	9,5	1174		80	9,5	1104			
BK	4000	90	9,5	1066	4000	90	9,5	1002			
		80	9,5	1232		80	9,5	1158			
	2700	90	9,5	840	BK	2700	90	9,5	730		
		80	9,5	981			80	9,5	854		
	3000	90	9,5	876	3000	90	9,5	762			
		80	9,5	1029		80	9,5	895			
	4000	90	9,5	934	4000	90	9,5	813			
		80	9,5	1080		80	9,5	939			





Kombic Surface 100
Opal ON/OFF 1500/2000

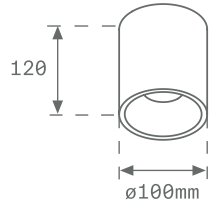

Kombic Surface 100
Opal DALI 1500/2000

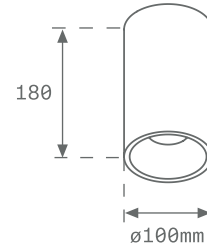

Kombic Surface 100
Opal TW 1500/2000

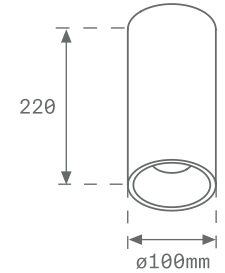

KOMBIC SURFACE 100 OPAL

Family	Installation	Lm LED	IP	Optic	CRI	K	Gear	Reflector Finishes	Ext. Finishes
K11	SF Surface	15 1500lm	40 IP 43	OP Opal	9 90	27 2700 K	N ON/OFF	R Bright	W White 02
		20 2000lm							
	20 2000lm	40 IP 43	OP Opal	8 80	30 3000 K	30 3000 K			
	25 2500lm								
K11	SF	15	40	OP	9	27	N	R	W

KOMBIC SURFACE 100 OPAL WELLBEING WB

Family	Installation	Lm LED	IP	Optic	K	Gear	Reflector Finishes	Ext. Finishes
K11	SF Surface	15 1500lm	40 IP 43	OP Opal	WB3 3000 WB	N ON/OFF	R Bright	W White 02
		20 2000lm						
							W White	
K11	SF	15	40	OP	WB3	N	R	W

KOMBIC SURFACE 100 OPAL TW

Family	Installation	Lm LED	IP	Optic	CRI	K	Gear	Reflector Finishes	Ext. Finishes
K11	SF Surface	20 2000lm	40 IP 43	OP Opal	9 90	TW Tunable White	D DALI	R Bright	W White 02
K11	SF	20	40	OP	9	TW	D	R	W





Kombic Surface 100 Track
Opal ON/OFF 1500/2000

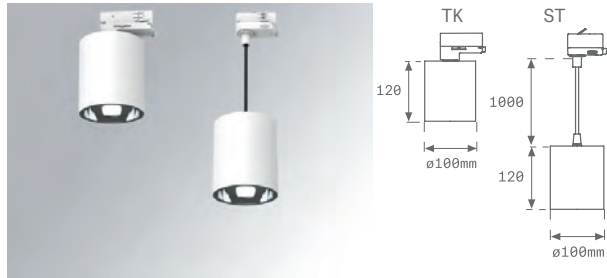

Kombic Surface 100 Track
Opal DALI 1500/2000/2500
Opal ON/OFF 2500

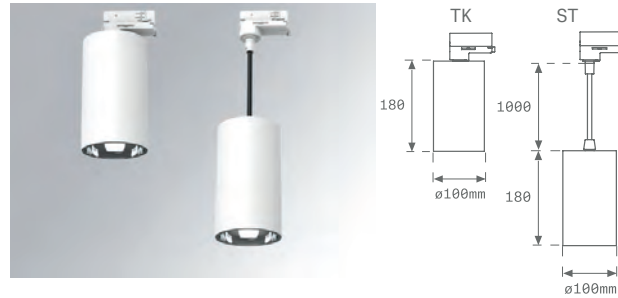

Kombic Surface 100 Track
Opal TW 1500/2000

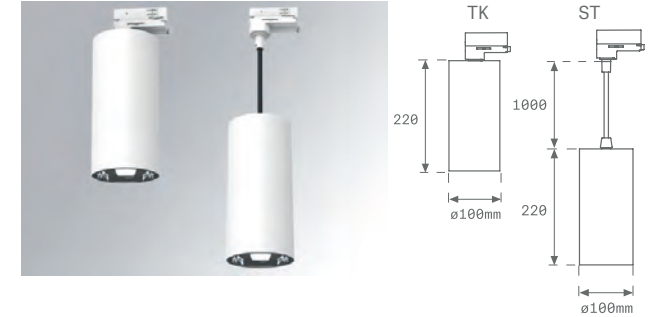

KOMBIC SURFACE 100 TRACK OPAL

Family	Installation	Lm LED	IP	Optic	CRI	K	Gear	Reflector Finishes	Ext. Finishes
K11	TK Track	15 1500lm	40 IP 43	OP Opal	9 90	27 2700 K	N ON/OFF D DALI	R Bright M Metalized Matt W White	W White 02 B Black 02
	ST Sus. Track	20 2000lm				30 3000 K			
		20 2000lm	40 IP 43	OP Opal	8 80	30 3000 K			
		25 2500lm				40 4000 K			
K11	TK	15	40	OP	9	27	N	R	W

KOMBIC SURFACE 100 TRACK OPAL WELLBEING

Family	Installation	Lm LED	IP	Optic	K	Gear	Reflector Finishes	Ext. Finishes
K11	TK Track	15 1500lm	40 IP 43	OP Opal	WB3 3000 WB	N ON/OFF D DALI	R Bright M Metalized Matt W White	W White 02 B Black 02
	ST Sus. Track	20 2000lm			WB4 4000 WB			
K11	TK	15	40	OP	WB3	N	R	W

KOMBIC SURFACE 100 TRACK OPAL TW

Family	Installation	Lm LED	IP	Optic	CRI	K	Gear	Reflector Finishes	Ext. Finishes
K11	TK Track	20 2000lm	40 IP 43	OP Opal	9 90	TW Tunable White	D DALI	R Bright M Metalized Matt W White	W White 02 B Black 02
	ST Sus. Track								
K11	TK	20	40	OP	9	TW	D	R	W



Kombic Surface 100
Optic ON/OFF 1500/2000

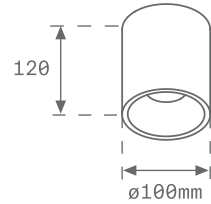

Kombic Surface 100
Optic DALI 1500/2000

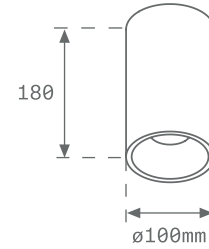

Kombic Surface 100
OpticTW 1500/2000

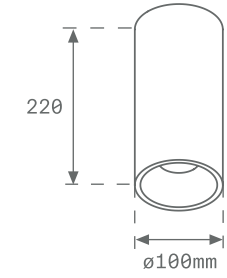

KOMBIC SURFACE 100 OPTIC

Family	Installation	Lm LED	IP	Optic	CRI	K	Gear	Reflector Finishes	Ext. Finishes			
K11	SF Surface	15 1500lm 20 2000lm	40 IP 43	WF Wide Flood 50°	9 90	27 2700 K 30 3000 K 40 4000 K	N ON/OFF D DALI	B Black M Metalized Matt W White	W White 02 B Black 02			
										20 2000lm 25 2500lm	40 IP 43	WF Wide Flood 50°
		15	40	WF	9	27						
		K11	SF									





Kombic Surface 100
Optic ON/OFF 1500/2000



Kombic Surface 100
Optic DALI 1500/2000



Kombic Surface 100
OpticTW 1500/2000



KOMBIC SURFACE 100 OPTIC WELLBEING WB

Family	Installation	Lm LED	IP	Optic	K	Gear	Reflector Finishes	Ext. Finishes
K11	SF Surface	15 1500lm 20 2000lm	40 IP 43	WF Wide Flood 50°	WB3 3000 WB WB4 4000 WB	N ON/OFF D DALI	B Black M Metalized Matt W White	W White 02 B Black 02
K11	SF	15	40	WF	WB3	N	B	W

KOMBIC SURFACE 100 OPTIC TW

Family	Installation	Lm LED	IP	Optic	CRI	K	Gear	Reflector Finishes	Ext. Finishes
K11	SF Surface	20 2000lm	40 IP 43	WF Wide Flood 50°	9 90	TW Tunable White	D DALI	B Black M Metalized Matt W White	W White 02 B Black 02
K11	SF	20	40	WF	9	TW	D	B	W



Kombic Surface 100
Reflector

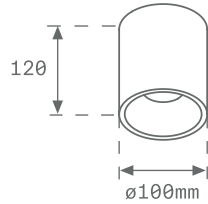

Kombic Surface 100
Reflector

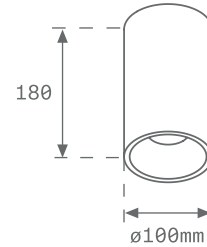

Kombic Surface 100
Reflector

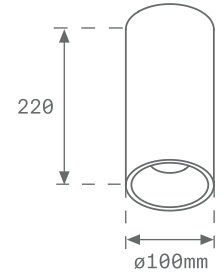

KOMBIC SURFACE 100 REFLECTOR

Family	Installation	Lm LED	IP	Optic	CRI	K	Gear	Reflector Finishes	Ext. Finishes
K11	SF Surface	15 1500lm	23 IP 23	RF Flood	9 90	27 2700 K	N ON/OFF D DALI	B Black	W White 02
	TK Track	20 2000lm		RW Wide Flood				30 3000 K	
	ST Sus. Track	20 2000lm 25 2500lm	23 IP 23	RF Flood	8 80	30 3000 K 40 4000 K		W White	
				RW Wide Flood				40 4000 K	
K11	SF	15	23	RF	9	27	N	B	W





Kombic Surface 100 Track

Optic ON/OFF 1500/2000



Kombic Surface 100 Track

Optic DALI 1500/2000/2500
Optic ON/OFF 2500



Kombic Surface 100 Track

Optic TW 1500/2000

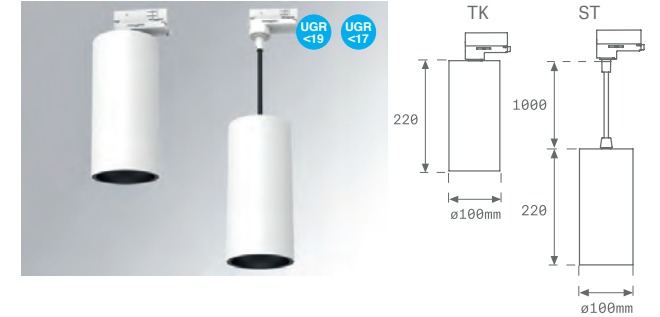

KOMBIC SURFACE 100 TRACK OPTIC

Family	Installation	Lm LED	IP	Optic	CRI	K	Gear	Reflector Finishes	Ext. Finishes
K11	TK Track	15 1500lm	40 IP 43	WF Wide Flood 50°	9	90	N ON/OFF	B Black	W White 02
	ST Sus. Track	20 2000lm					D DALI	M Metalized Matt	B Black 02
		20 2000lm	40 IP 43	WF Wide Flood 50°	8	80		W White	
		25 2500lm							
K11	TK	15	40	WF	9	27	N	B	W

KOMBIC SURFACE 100 TRACK OPTIC WELLBEING WB

Family	Installation	Lm LED	IP	Optic	K	Gear	Reflector Finishes	Ext. Finishes
K11	TK Track	15 1500lm	40 IP 43	WF Wide Flood 50°	WB3 3000 WB	N ON/OFF	B Black	W White 02
	ST Sus. Track	20 2000lm			WB4 4000 WB	D DALI	M Metalized Matt	B Black 02
K11	TK	15	40	WF	WB3	N	B	W

KOMBIC SURFACE 100 TRACK OPTIC TW

Family	Installation	Lm LED	IP	Optic	CRI	K	Gear	Reflector Finishes	Ext. Finishes
K11	TK Track	20 2000lm	40 IP 43	WF Wide Flood 50°	9	90	TW Tunable White	B Black	W White 02
	ST Sus. Track						D DALI	M Metalized Matt	B Black 02
K11	TK	20	40	WF	9	TW	D	B	W





TECHNICAL CHARACTERISTICS

Optics

OPAL

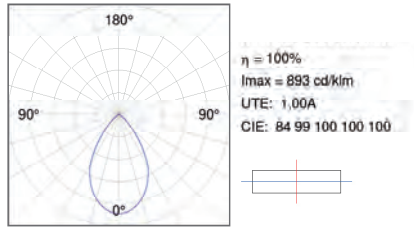

OPTIC

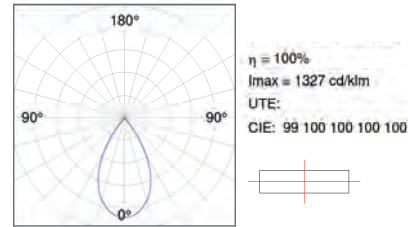

Light output and power

KOMBIC SURFACE 100 OPAL

	K	CRI	1500lm		2000lm		2500lm	
			W	lm Output	W	lm Output	W	lm Output
BR	2700	90	13,4	1191	19,1	1598	-	-
		80	-	-	-	-	-	-
	3000	90	13,4	1230	19,1	1648	-	-
		80	-	-	13,4	1460	19,1	1959
	4000	90	13,4	1336	19,1	1792	-	-
		80	-	-	13,4	1547	19,1	2082
MA	2700	90	13,4	1135	19,1	1523	-	-
		80	-	-	-	-	-	-
	3000	90	13,4	1172	19,1	1571	-	-
		80	-	-	13,4	1392	19,1	1867
	4000	90	13,4	1273	19,1	1708	-	-
		80	-	-	13,4	1474	19,1	1978
WH	2700	90	13,4	1186	19,1	1591	-	-
		80	-	-	-	-	-	-
	3000	90	13,4	1225	19,1	1642	-	-
		80	-	-	13,4	1454	19,1	1951
	4000	90	13,4	1330	19,1	1785	-	-
		80	-	-	13,4	1541	19,1	2067

KOMBIC SURFACE 100 OPTIC

	K	CRI	1500lm		2000lm		2500lm	
			W	lm Output	W	lm Output	W	lm Output
BK	2700	90	13,4	983	19,1	1312	-	-
		80	-	-	-	-	-	-
	3000	90	13,4	1015	19,1	1354	-	-
		80	-	-	13,7	1205	19,8	1609
	4000	90	13,4	1102	19,1	1472	-	-
		80	-	-	13,7	1277	19,8	1704
MA	2700	90	13,4	1030	19,1	1380	-	-
		80	-	-	-	-	-	-
	3000	90	13,4	1068	19,1	1424	-	-
		80	-	-	13,7	1268	19,8	1692
	4000	90	13,4	1160	19,1	1548	-	-
		80	-	-	13,7	1343	19,8	1792
WH	2700	90	13,4	1040	19,1	1387	-	-
		80	-	-	-	-	-	-
	3000	90	13,4	1074	19,1	1432	-	-
		80	-	-	13,7	1275	19,8	1701
	4000	90	13,4	1166	19,1	1556	-	-
		80	-	-	13,7	1351	19,8	1802



TECHNICAL CHARACTERISTICS

Light output and power

KOMBIC SURFACE 100 OPAL WELLBEING

	K	CRI	1200lm		1800lm	
			W	lm Output	W	lm Output
BR	3000	95	13,9	971	20	1316
	4000	95	13,9	1031	20	1394
MA	3000	95	13,9	929	20	1243
	4000	95	13,9	986	20	1317
WH	3000	95	13,9	951	20	1206
	4000	95	13,9	1035	20	1398

KOMBIC SURFACE 100 OPTIC WELLBEING

	K	CRI	1200lm		1800lm	
			W	lm Output	W	lm Output
BK	3000	95	13,9	835	20	1109
	4000	95	13,9	885	20	1175
MA	3000	95	13,9	862	20	1185
	4000	95	13,9	914	20	1255
WH	3000	95	13,9	857	20	1057
	4000	95	13,9	947	20	1263

KOMBIC SURFACE 100 REFLECTOR WF

	K	CRI	1500lm		2000lm		2500lm		
			W	lm Output	W	lm Output	W	lm Output	
WF	BK	2700	90	14,5	1168	19,8	1568	-	-
			80	-	-	-	-	-	-
		3000	90	14,5	1218	19,8	1636	-	-
	MA	2700	90	14,5	1264	19,8	1710	-	-
			80	-	-	-	-	-	-
		3000	90	14,5	1318	19,8	1784	-	-
WH	BK	2700	90	14,5	1264	19,8	1710	-	-
			80	-	-	-	-	-	-
		3000	90	14,5	1318	19,8	1784	-	-
	MA	2700	90	14,5	1406	19,8	1902	-	-
			80	-	-	14,5	1614	19,8	2184
		3000	90	14,5	1406	19,8	1902	-	-
WH	2700	90	14,5	1264	19,8	1710	-	-	
		80	-	-	-	-	-	-	
	3000	90	14,5	1318	19,8	1784	-	-	
MA	2700	90	14,5	1406	19,8	1902	-	-	
		80	-	-	14,5	1614	19,8	2184	
	3000	90	14,5	1406	19,8	1902	-	-	
WH	2700	90	14,5	1264	19,8	1710	-	-	
		80	-	-	-	-	-	-	
	3000	90	14,5	1318	19,8	1784	-	-	

KOMBIC SURFACE 100 REFLECTOR FL

	K	CRI	1500lm		2000lm		2500lm		
			W	lm Output	W	lm Output	W	lm Output	
FL	BK	2700	90	14,5	1273	19,8	1711	-	-
			80	-	-	-	-	-	-
		3000	90	14,5	1328	19,8	1785	-	-
	MA	2700	90	14,5	1416	19,8	1903	-	-
			80	-	-	14,5	1226	19,8	2185
		3000	90	14,5	1382	19,8	1893	-	-
WH	BK	2700	90	14,5	1474	19,8	2019	-	-
			80	-	-	14,5	1692	19,8	2318
		3000	90	14,5	1474	19,8	2019	-	-
	MA	2700	90	14,5	1325	19,8	1815	-	-
			80	-	-	-	-	-	-
		3000	90	14,5	1382	19,8	1893	-	-
WH	2700	90	14,5	1325	19,8	1815	-	-	
		80	-	-	-	-	-	-	
	3000	90	14,5	1382	19,8	1893	-	-	
MA	2700	90	14,5	1474	19,8	2019	-	-	
		80	-	-	14,5	1692	19,8	2318	
	3000	90	14,5	1474	19,8	2019	-	-	
WH	2700	90	14,5	1325	19,8	1815	-	-	
		80	-	-	-	-	-	-	
	3000	90	14,5	1382	19,8	1893	-	-	



ACCESSORIES

Rigid suspension for electrical connection



Ref.	Color	m
K1SUCARG0500NW	○	0,5
K1SUCARG0500DW	○	0,5
K1SUCARG0500NB	●	0,5
K1SUCARG0500DB	●	0,5
K1SUCARG1000NW	○	1
K1SUCARG1000DW	○	1
K1SUCARG1000NB	●	1
K1SUCARG1000DB	●	1

Suspension



Ref.	Color	m
K1SUCAWI2000NW	○	2
K1SUCAWI2000DW	○	2
K1SUCAWI2000NB	●	2
K1SUCAWI2000DB	●	2

Cable grommets



Ref.	Color
K11SUADLATWH	○
K11SUADLATBK	●

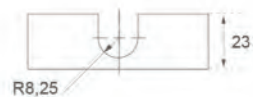



Kombic Surface 150

Opal

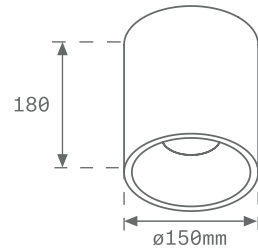

KOMBIC SURFACE 150 OPAL

Family	Installation	Lm LED	IP	Optic	CRI	K	Gear	Reflector Finishes	Ext. Finishes					
K21	SF Surface	20 2000lm	40 IP 43	OP Opal	9 90	27 2700 K	N ON/OFF	R Bright	W White 02					
		30 3000lm								8 80	30 3000 K	D DALI	M Metalized Matt	B Black 02
		35 3500lm												
K21	SF	20	40	OP	9	27	N	R	W					

KOMBIC SURFACE 150 OPAL WELLBEING WB

Family	Installation	Lm LED	IP	Optic	K	Gear	Reflector Finishes	Ext. Finishes
K21	SF Surface	20 2000lm	40 IP 43	OP Opal	WB3 3000 WB	N ON/OFF	R Bright	W White 02
		25 2500lm			WB4 4000 WB			
K21	SF	20	40	OP	WB3	N	R	W

KOMBIC SURFACE 150 OPAL TW

Family	Installation	Lm LED	IP	Optic	CRI	K	Gear	Reflector Finishes	Ext. Finishes
K21	SF Surface	30 3000lm	40 IP 43	OP Opal	9 90	TW Tunable White	D DALI	R Bright M Metalized Matt W White	W White 02 B Black 02
K21	SF	30	40	OP	9	TW	D	R	W



Kombic Surface 150

Optic



UGR <15

UGR <17

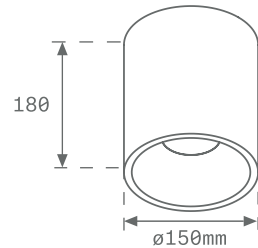

KOMBIC 150 OPTIC

Family	Installation	Lm LED	IP	Optic	CRI	K	Gear	Reflector Finishes	Ext. Finishes		
K21	SF Surface	20 2000lm	40 IP 43	WF Wide Flood 50°	9 90	27 2700 K	N ON/OFF D DALI	B Black M Metalized Matt W White	W White 02 B Black 02		
		30 3000lm								8 80	30 3000 K
		35 3500lm									
K21	SF	20	40	WF	9	27	N	B	W		

KOMBIC SURFACE 150 OPTIC WELLBEING WB

Family	Installation	Lm LED	IP	Optic	K	Gear	Reflector Finishes	Ext. Finishes
K21	SF Surface	20 2000lm	40 IP 43	WF Wide Flood 50°	WB3 3000 WB	N ON/OFF D DALI	B Black M Metalized Matt W White	W White 02 B Black 02
		25 2500lm						
K121	SF	20	40	WF	WB3	N	B	W

KOMBIC SURFACE 150 OPTIC TW

Family	Installation	Lm LED	IP	Optic	CRI	K	Gear	Reflector Finishes	Ext. Finishes
K21	SF Surface	30 3000lm	40 IP 43	WF Wide Flood 50°	9 90	TW Tunable White	D DALI	B Black M Metalized Matt W White	W White 02 B Black 02
K21	SF	30	40	WF	9	TW	D	B	W





TECHNICAL CHARACTERISTICS

Optics

OP

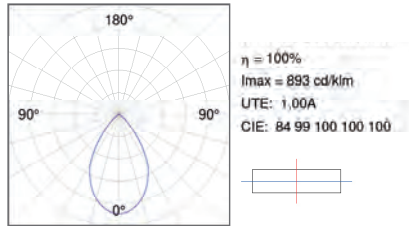

WFL 50°

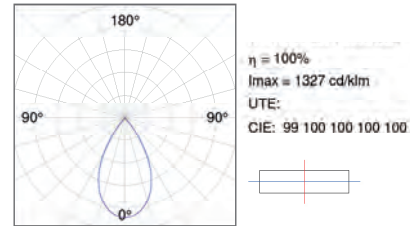

Light output and power

KOMBIC SURFACE 150 OPAL

	K	CRI	2000lm		3000lm		3500lm	
			W	lm Output	W	lm Output	W	lm Output
BR	2700	90	19,8	1675	27,7	2227	-	-
		80	-	-	-	-	-	-
	3000	90	19,8	1739	27,7	2312	-	-
		80	13,4	1488	19,9	2096	27,7	2788
	4000	90	19,8	1874	27,7	2492	-	-
		80	13,4	1550	19,9	2184	27,7	2904
TW	90	23,9	1653	-	-	-	-	
MA	2700	90	19,8	1606	27,7	2135	-	-
		80	-	-	-	-	-	-
	3000	90	19,8	1667	27,7	2216	-	-
		80	13,4	1427	19,9	2010	27,7	2673
	4000	90	18	1797	27,7	2389	-	-
		80	12	1486	19,9	2094	27,7	2784
TW	90	23,9	1737	-	-	-	-	
WH	2700	90	19,8	1658	27,7	2203	-	-
		80	-	-	-	-	-	-
	3000	90	19,8	1720	27,7	2288	-	-
		80	13,4	1473	19,9	2074	27,7	2759
	4000	90	18	1854	27,7	2466	-	-
		80	12	1534	19,9	2161	27,7	2874
TW	90	23,9	1721	-	-	-	-	

KOMBIC SURFACE 150 OPTIC

	K	CRI	2000lm		3000lm		3500lm	
			W	lm Output	W	lm Output	W	lm Output
BK	2700	90	19,8	1289	27,7	1713	-	-
		80	-	-	-	-	-	-
	3000	90	19,8	1739	27,7	1779	-	-
		80	13,4	1145	19,9	1613	27,7	2145
	4000	90	19,8	1874	27,7	1917	-	-
		80	13,4	1193	19,9	1680	27,7	2235
TW	90	23,9	1352	-	-	-	-	
MA	2700	90	19,8	1293	27,7	1718	-	-
		80	-	-	-	-	-	-
	3000	90	19,8	1667	27,7	1784	-	-
		80	13,4	1148	19,9	1618	27,7	2151
	4000	90	18	1797	27,7	1923	-	-
		80	12	1196	19,9	1685	27,7	2241
TW	90	23,9	1362	-	-	-	-	
WH	2700	90	19,8	1332	27,7	1771	-	-
		80	-	-	-	-	-	-
	3000	90	19,8	1720	27,7	1838	-	-
		80	13,4	1184	19,9	1677	27,7	2217
	4000	90	18	1854	27,7	1982	-	-
		80	12	1233	19,9	1737	27,7	2310
TW	90	23,9	1381	-	-	-	-	

Kombic Surface | Indoor

TECHNICAL CHARACTERISTICS

FAMILY PRESENTATION

Ind.



Light output and power

KOMBIC SURFACE 150 OPAL WELLBEING

	K	CRI	2000lm		2500lm	
			W	lm Output	W	lm Output
BR	3000	97	19	1368	27,4	1932
	4000	97	19	1491	27,4	2190
MA	3000	97	19	1308	27,4	1884
	4000	97	19	1429	27,4	2075
WH	3000	97	19	1361	27,4	1951
	4000	97	19	1474	27,4	2170

KOMBIC SURFACE 150 OPTIC WELLBEING

	K	CRI	2000lm		2500lm	
			W	lm Output	W	lm Output
BK	3000	97	19	1192	27,4	1543
	4000	97	19	1297	27,4	1652
MA	3000	97	19	1205	27,4	1567
	4000	97	19	1321	27,4	1713
WH	3000	97	19	1208	27,4	1596
	4000	97	19	1335	27,4	1711

ACCESSORIES

Rigid suspension for electrical connection



Ref.	Color	m
K2SUCARG0500NW	○	0,5
K2SUCARG0500DW	○	0,5
K2SUCARG0500NB	●	0,5
K2SUCARG0500DB	●	0,5
K2SUCARG1000NW	○	1
K2SUCARG1000DW	○	1
K2SUCARG1000NB	●	1
K2SUCARG1000DB	●	1

Suspension



Ref.	Color	m
K2SUCAWI2000NW	○	2
K2SUCAWI2000DW	○	2
K2SUCAWI2000NB	●	2
K2SUCAWI2000DB	●	2

Cable grommets



Ref.	Color
K21SUADLATWH	○
K21SUADLATBK	●

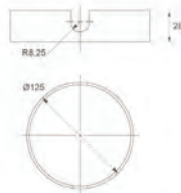

Kombic Surface 200

Opal

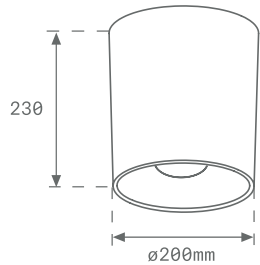

KOMBIC 200 OPAL

Family	Installation	Lm LED	IP	Optic	CRI	K	Gear	Reflector Finishes	Ext. Finishes
K32	SF Surface	30 3000lm 40 4000lm	20 IP 20	OP Opal	8 80	30 3000 K 40 4000 K	N ON/OFF	Bright	W White O2 B Black O2
K32	SF	30	20	OP	8	30	N	R	W

TECHNICAL CHARACTERISTICS

Optics

OPAL

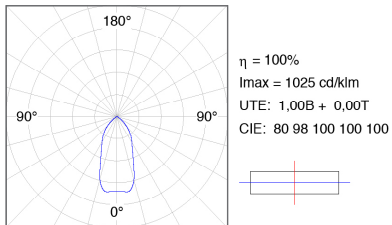

Light output and power

KOMBIC 200 SURFACE OPAL

	K	CRI	3000lm		4000lm	
			W	lm Output	W	lm Output
BR	3000	80	16,7	2181	24,1	3025
	4000	80	16,7	2304	24,1	3195
WH	3000	80	16,7	2181	24,1	3025
	4000	80	16,7	2304	24,1	3195





ACCESSORIES

Two steel cables electromechanical suspension



Ref.	Color	h(m)
SUEM2W3000NW	○	max. 3
SUEM2W3000NG	●	max. 3

Upper decorative cover for suspended model



Ref.	Color
K3SUC0W	○

Electromechanical rigid



Ref.	Color	h(mm)
SUCARG0100W	○	100
SUCARG0100G	●	100
SUCARG0250W	○	250
SUCARG0250G	●	250
SUCARG0500W	○	500
SUCARG0500G	●	500
SUCARG01000W	○	1000
SUCARG01000G	●	1000



Lamptub 60



Lamptub 60
Suspended Direct Rec



Lamptub 60
Suspended Direct Sur

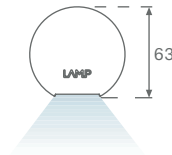

Lamptub 60
Suspended Dir/Ind

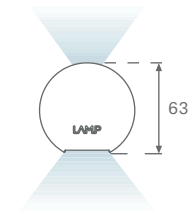

LAMPTUB 60 SUSPENDED DIRECT

Family	Installation	Rose	Format	Lm LED/m	Optic	CRI	K	Gear	Finishes			
L61	S Suspended	E Recessed	084 840mm	LO 1500lm	OP Opal	9 90	27 2700 K	N ON/OFF	W White			
		S Surface	112 1120mm	MO 3000lm	OC Opal Comfort					30 3000 K	D DALI	B Black
			168 1680mm							40 4000 K		3 Wellbeing
L61	S Suspended	E Recessed	084 840mm	MO 2600lm	TE Tech	9 90	30 3000 K	N ON/OFF	W White			
		S Surface	112 1120mm							40 4000 K	D DALI	B Black
			168 1680mm									3 Wellbeing
L61	S Suspended	E Recessed	084 840mm	LO 1500lm	OC Opal Comfort	9 90	TW Tunable White	D DALI	W White			
		S Surface	112 1120mm	MO 3000lm						30 3000 K	B Black	
			168 1680mm									40 4000 K
L61	S	E	084	LO	OP	9	27	N	W			

LAMPTUB 60 SUSPENDED DIR/IND

Family	Installation	Rose	Format	Lm LED/m	Optic	CRI	K	Gear	Finishes		
L61	S Suspended	E Recessed	084 840mm	LO 1500lm	IO Dir/Ind Opal	9 90	27 2700 K	N ON/OFF	W White		
			112 1120mm	MO 2600lm	IP Dir/Ind Opal Comfort					30 3000 K	B Black
			168 1680mm								
L61	S Suspended	E Recessed	084 840mm	LO 1500lm	IP Dir/Ind Opal Comfort	9 90	TW Tunable White	D DALI	W White		
			112 1120mm	MO 2600lm						30 3000 K	B Black
			168 1680mm								
L61	S	E	084	LO	IO	9	27	N	W		





NS

Lamptub 60
Track Surface



Lamptub 60
Track Suspended

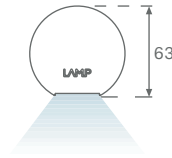

Lamptub 60
Track Dir/Ind

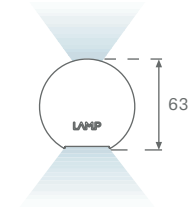

LAMPTUB 60 TRACK DIRECT

				Lm LED/m				K								
L61	TK	Track Surface	084	840mm	LO	1500lm	OP	Opal	9	90	27	2700 K	N	ON/OFF	W	White
	ST	Track Suspended	112	1120mm	MO	3000lm	OC	Opal Comfort			30	3000 K	D	DALI	B	Black
			168	1680mm							40	4000 K			3	Wellbeing
		4	Be Social													
L61	TK	Track Surface	084	840mm	MO	2600lm	TE	Tech	9	90	30	3000 K	N	ON/OFF	W	White
	ST	Track Suspended	112	1120mm							40	4000 K	D	DALI	B	Black
			168	1680mm											3	Wellbeing
		4	Be Social													
L61	TK		084		LO		OP		9		27		N		W	

LAMPTUB 60 TRACK DIR/IND

				Lm LED/m				K								
L61	ST	Track Suspended	084	840mm	LO	1500lm	IO	Dir/Ind Opal	9	90	27	2700 K	N	ON/OFF	W	White
			112	1120mm	MO	2600lm	IP	Dir/Ind Opal Comfort			30	3000 K	D	DALI	B	Black
			168	1680mm							40	4000 K			3	Wellbeing
		4	Be Social													
L61	ST		084		LO		IO		9		27		N		W	





TECHNICAL CHARACTERISTICS

Optics

OP

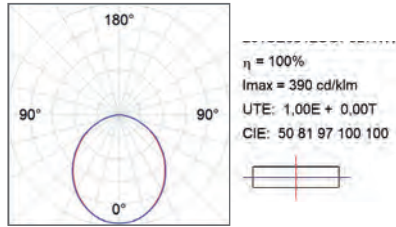

OC

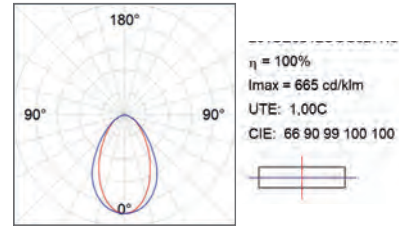

TE

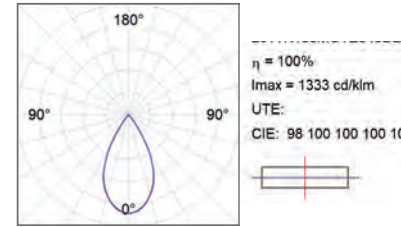

Light output and power

Light output and power

LAMPTUB 60 DIRECT

				840mm		1120mm		1680mm		
		K	CRI	W	lm Output	W	lm Output	W	lm Output	
LO	OP	2700	90	9,7	716	12,9	955	17,9	1433	
		3000	90	9,7	754	12,9	1005	17,9	1508	
		4000	90	9,7	778	12,9	1038	17,9	1556	
	OC	2700	90	9,7	663	12,9	884	17,9	1326	
		3000	90	9,7	698	12,9	931	17,9	1396	
		4000	90	9,7	720	12,9	961	17,9	1441	
MO	OP	2700	90	17,8	1468	25,4	1957	34,7	2936	
		3000	90	17,8	1544	25,4	2060	34,7	3089	
		4000	90	17,8	1594	25,4	2126	34,7	3189	
	OC	2700	90	17,8	1358	25,4	1912	34,7	2717	
		3000	90	17,8	1430	25,4	1906	34,7	2860	
		4000	90	17,8	1476	25,4	1968	34,7	2951	
	TE	2700	-	-	-	-	-	-	-	-
		3000	90	13,7	1260	17,8	1680	26,7	2520	
		4000	90	13,7	1320	17,8	1760	26,7	2640	



TECHNICAL CHARACTERISTICS

Optics

I0

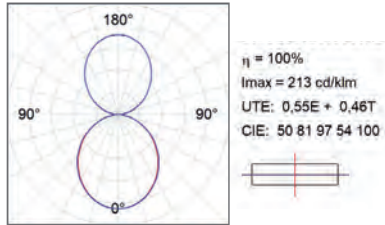

IP

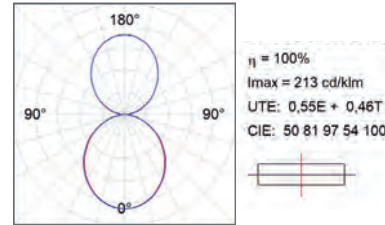

Light output and power

LAMPTUB 60 DIRECT/INDIRECT

				840mm		1120mm		1680mm		
	K	CRI	W	lm Output	W	lm Output	W	lm Output		
LO	IO	90	2700	7,9 9,5	600 717	10,6 12	840 955	18,5 17	1320 1433	
			3000	7,9 9,5	632 754	10,6 12	884 1005	17 17	1389 1508	
			4000	7,9 9,5	652 778	10,6 12	912 1038	17 17	1433 1557	
	IP	90	2700	7,9 9,5	599 662	10,6 12	840 884	17 34	1319 1327	
			3000	7,9 9,5	630 698	10,6 12	883 931	17 17	1388 1396	
			4000	7,9 9,5	651 720	10,6 12	911 961	17 17	1433 1441	
		MO	90	2700	7,9 18	600 1468	11 25	841 1957	17 34	1321 2936
				3000	7,9 18	632 1545	11 25	884 2060	17 34	1390 3089
				4000	7,9 18	652 1594	11 25	913 2126	17 34	1434 3189
IP	90	2700	7,9 18	600 1359	11 25	839 1812	17 34	1320 2717		
		3000	7,9 18	631 1430	11 25	884 1906	17 34	1388 2860		
		4000	7,9 18	651 1476	11 25	912 1968	17 34	1433 2951		



ACCESSORIES

End cover



Ref.

L6SUECB
L6SUECW
L6SUECW3
L6SUECW4

Color



Wellbeing Be Social: W4



4050-R90B



1050-B10G



7502-R



2070-Y80R



2011

Wellbeing Wellbeing: W3



4050-R90B



1505-Y10R



7024



4030-B50G



7001



Lamptub 80



Lamptub 80



LAMPTUB 80

Family	Installation	Format	Lm LED/m	Optic	CRI	K	Gear	Finishes
LA1	SF Surface	120 1162mm	LO 2320	OP Opal	8 80	30 3000 K	N ON/OFF	W White 02
		170 1743mm	MO 3928					
LA1	SF	170	LO	OP	8	30	N	W

TECHNICAL CHARACTERISTICS

Optics

OP

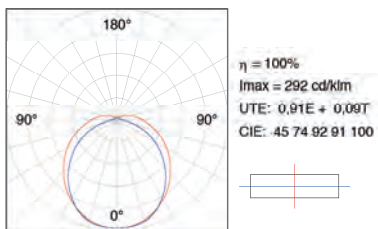

Light output and power

LAMPTUB 80

				1162lm		1743lm	
		K	CRI	W	lm Output	W	lm Output
LO	LO	3000	80	19,2	2278	29,7	3601
		4000	80	19,2	2322	29,7	3683
MO	OP	3000	80	30,7	3896	45,8	6161
		4000	80	30,7	3986	45,8	6299





ACCESSORIES

Profile and cover (max. 3m)



Ref.	Color
LAPRSUX/MMW	○
LACOSUX/MMW	○

90° corner joint



Ref.	Color
LASUHCW	○



Set of 2 fixings per joint (2 units for each reference)



Ref.
F5J0

Wall bracket joint



Ref.	Color	Lmm
F5FX75W	○	75

End cover



Ref.	Color
LASUECW	○



Opal difuser



Ref.	Color
LADIX/MMOP	○

Wall bracket with cover included (2 units for each reference)



END Ref.	Color	INTERMEDIATE Ref.	Color
LAWASFEDW	○	LAWASFIDW	○



Modular Custom



Modular Custom Air



MODULAR CUSTOM AIR

Family	Format	Lm LED	Optic	CRI	K	Gear	Finishes
MCA1	1212 1200x120	35 3400lm	PR Prismatic	8 80	30 3000 K 40 4000 K	N ON/OFF D DALI	W White 04
	1230 1200x300	45 4500lm					
	9030 900x300	35 3500lm					
MCA1	1230	45	PR	8	40	N	W

Consult available dimensions for integration in different ceiling formats and the accessories in the **family presentation**.

TECHNICAL CHARACTERISTICS

Optics

PR

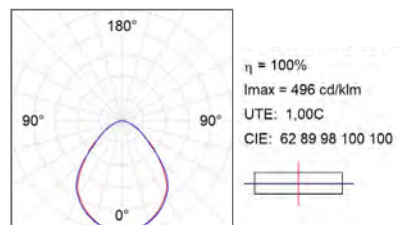



Modular Custom Efficiency



MODULAR CUSTOM EFFICIENCY

Family	Format	Lm LED	Optic	CRI	K	Gear	Finishes
MCE1	1212 1200x120	40 4000lm	PR Prismatic	8 80	30 3000 K 40 4000 K	N ON/OFF	W White 04
	1230 1200x300	50 5000lm					
MCE1	1212	40	PR	8	30	N	W

Consult available dimensions for integration in different ceiling formats and the accessories in the **family presentation**.

TECHNICAL CHARACTERISTICS

Optics

PR

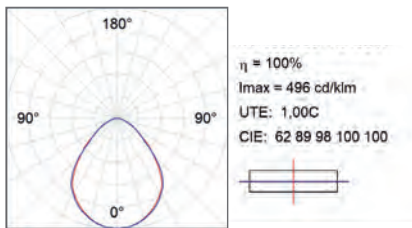



ACCESSORIES

3, 4, 5 and 6 ceiling anchoring system
(4 units per reference, not included on the luminaire)



Ref.

MLREFX

Color



Possible ceiling types for this luminaire

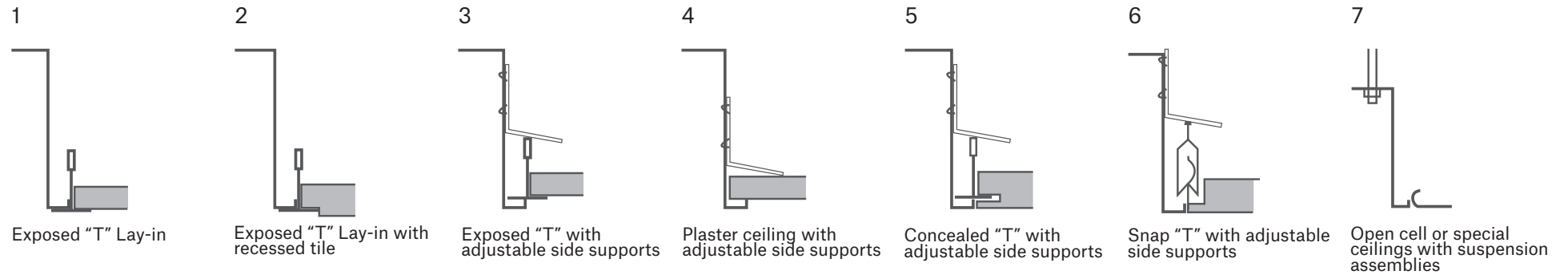



Ind.

Moody



Moody
Core 800

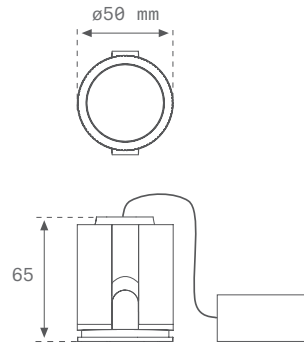

Moody
Core 1700

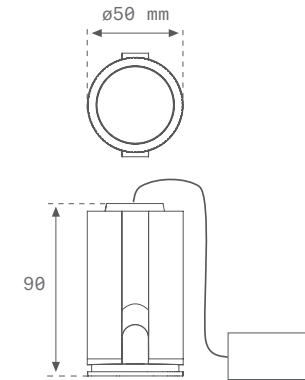

MOODY

Family	Lm LED	Optic	CRI	K	Gear	Finishes
M02	08 800lm	SP SP 17°	9 90	27 2700 K	T TRIAC D DALI	B Black 07
	15 1700lm	FL FL 36°				
		WF WFL 55°	8 80	30 3000 K 40 4000 K		
M02	08	SP	9	27	T	B





TECHNICAL CHARACTERISTICS

Optics

SP 18°

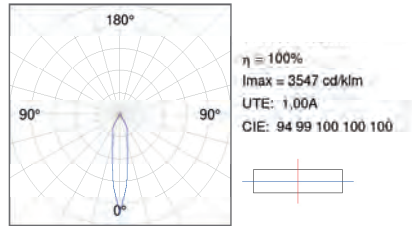

FL 36°

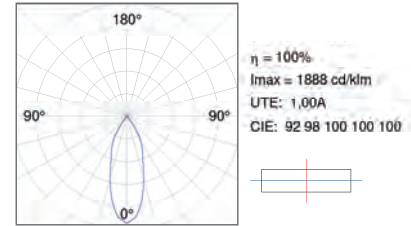

WFL 55°

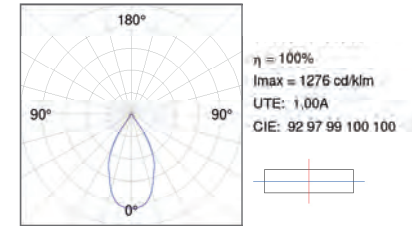

Light output and power



MOODY

	K	CRI	800lm		1500lm	
			W	lm Output	W	lm Output
SP	2700	90	6,1	435	14	927
17°	3000	80	6,1	533	14	1137
	4000	80	6,1	565	14	1204

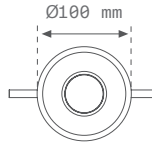

REFLECTOR

Moody fixed round reflector

	Ref.	Color	Pict.	
	MORFRD100FXB MORFRD100FXC MORFRD100FXM MORFRD100FXW	● ● ● ○	  ø 95	

Moody adjustable round reflector

	Ref.	Color	Pict.	
	MORFRD100ADB MORFRD100ADC MORFRD100ADM MORFRD100ADW	● ● ● ○	  ø 95	



Moody asymmetrical round reflector

	Ref.	Color	Pict.	
	MORFRD100ASB MORFRD100ASC MORFRD100ASM MORFRD100ASW	● ● ● ○	  ø 95	

Moody fixed square reflector

	Ref.	Color	Pict.	
	MORFSQ100FXB MORFSQ100FXC MORFSQ100FXM MORFSQ100FXW	● ● ● ○	  95 x 95	

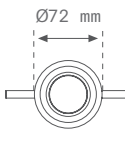
Moody mini reflector

	Ref.	Color	Pict.	
	MORFRD072FXB MORFRD072FXC MORFRD072FXM MORFRD072FXW	● ● ● ○	  ø 68	

Moody IP55 reflector

	Ref.	Color
	MORFRD100FX55B MORFRD100FX55W	● ○



ACCESSORIES

Transparent diffuser



Ref.
MOTRIP44

Pict.
IP
44

Refractor for elliptical distribution of luminous flu



Ref.
MOEL

Pict.
IP
44

Anti-glare honeycomb grille

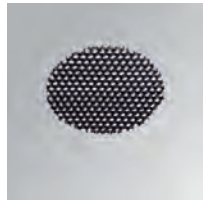

Ref.
MOHOB

Buffer



Ref.
MOCUFL
MOCUMF
MOCUVWF

Pict.
IP
44
-

Bulb socket adapter



Ref.
MOADGU10
MOADGU53

Pict.
GU10
PAR51 LED
GU 5,3
MR16 LED



Moody Core 800 with recessed reflector

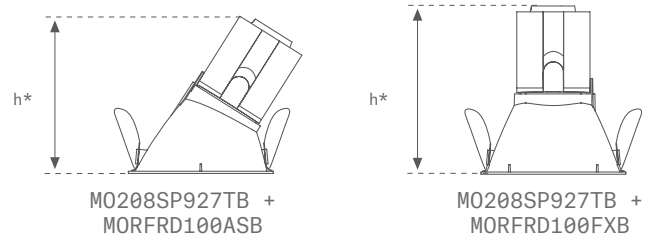

* See height (h) in the instruction sheet.

Moody Core 1700 with recessed reflector

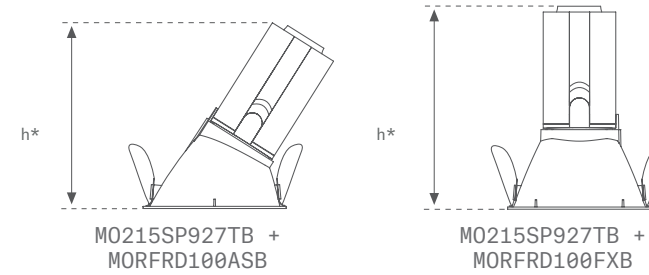

* See height (h) in the instruction sheet.

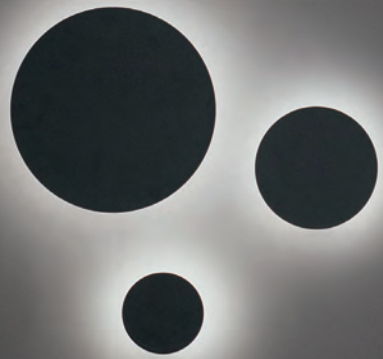
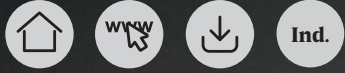

Mun Dark



Mun Dark
120



Mun Dark
180

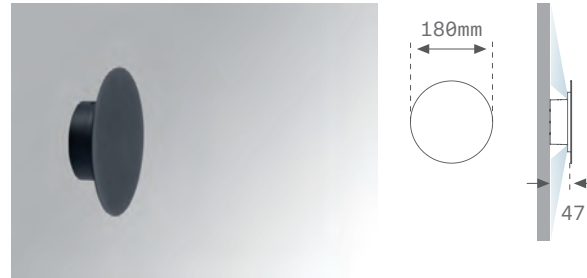

Mun Dark
300

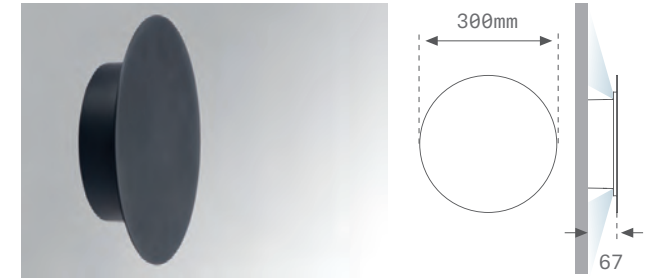

MUN DARK 120

Family	Format	Installation	Lm LED	IP	CRI	K	Gear	Finishes
MD1	120 120mm	SF Surface	01 100lm	20 20	8 80	30 3000 K 40 4000 K	N ON/OFF	W White 05 B Black 05
MD1	120	SF	01	20	8	30	N	W

MUN DARK 180

Family	Format	Installation	Lm LED	IP	CRI	K	Gear	Finishes
MD1	180 180mm	SF Surface	01 150lm	20 20	8 80	30 3000 K 40 4000 K	N ON/OFF	W White 05 B Black 05
MD1	180	SF	01	20	8	30	N	W

MUN DARK 300

Family	Format	Installation	Lm LED	IP	CRI	K	Gear	Finishes
MD1	300 300mm	SF Surface	01 300lm	20 20	8 80	30 3000 K 40 4000 K	N ON/OFF	W White 05 B Black 05
MD1	300	SF	01	20	8	30	N	W





TECHNICAL CHARACTERISTICS

Optics

MUN DARK 120

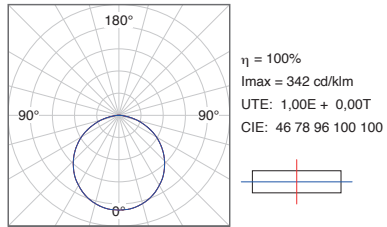

MUN DARK 180

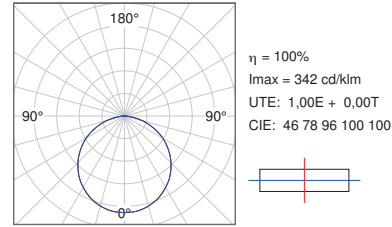

MUN DARK 300

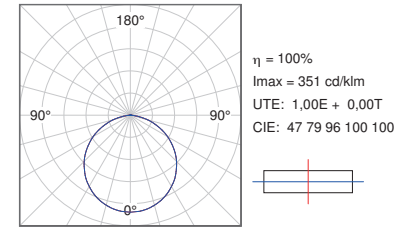

Light output and power

MUN DARK 120

		100lm			
Color	K	CRI	W	Im Output	
W	3000	80	1	30	
B	4000	80	1	30	

MUN DARK 180

		150lm			
Color	K	CRI	W	Im Output	
W	3000	80	1	45	
B	4000	80	1	45	

MUN DARK 300

		300lm			
Color	K	CRI	W	Im Output	
W	3000	80	3	90	
B	4000	80	3	90	



Mun Light



Mun Light
350

Mun Light
450

Mun Light
600

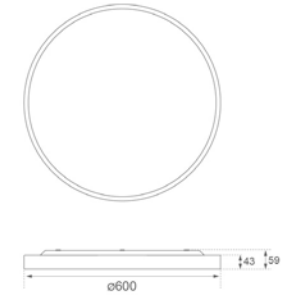
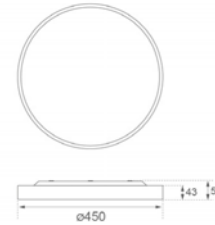
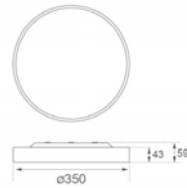

MUN LIGHT

Family	Installation	Format	Lm LED	Optics	CRI	K	Gear	Finishes
ML2	SF Surface	35 350mm	LO 1800 MO 2800	PR Prismatic	9 90	30 3000 K 40 4000 K	N ON/OFF D DALI	W White 05 B Black 05
		45 450mm	LO 2600 MO 4500					
		60 600mm	LO 4800 MO 7100					
ML2	SF	35	MO	PR	9	30	N	W



TECHNICAL CHARACTERISTICS

Optics

MUN LIGHT 350

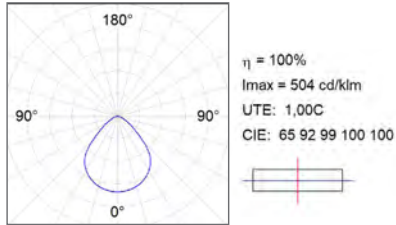

MUN LIGHT 450

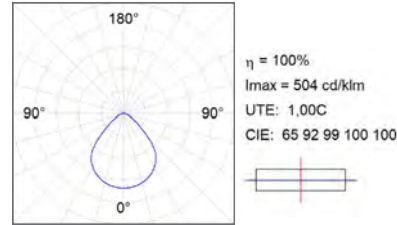

MUN LIGHT 600

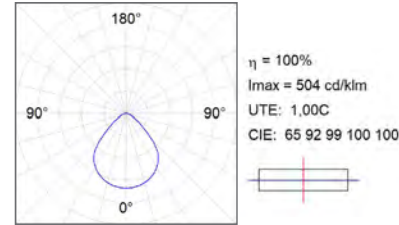

Light output and power

MUN LIGHT

	K	CRI	350mm		450mm		600mm	
			W	lm Output	W	lm Output	W	lm Output
LO B/W	3000	90	12	1254	16,5	1820	26,8	3285
	4000	90	12	1392	16,5	2020	26,8	3646
MO B/W	3000	90	16,6	1881	26,8	3046	39,9	4819
	4000	90	16,6	2113	26,8	3381	39,9	5349

ACCESSORIES

Suspension



Ref.	Color	mm
ML2SUEMSF1500NW	○	1500
ML2SUEMSF1500NB	●	1500
ML2SUEMSF3000NW	○	3000
ML2SUEMSF3000NB	●	3000
ML2SUEMSF1500DW	○	1500
ML2SUEMSF1500DB	●	1500
ML2SUEMSF3000DW	○	3000
ML2SUEMSF3000DB	●	3000



Ocult Downlight



Ocult Downlight
Recessed 2 Modules

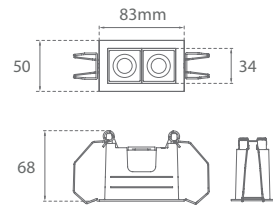

Ocult Downlight
Recessed 3 Modules

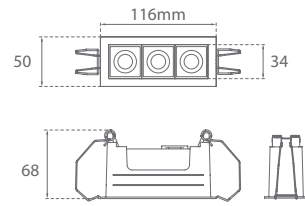

Ocult Downlight
Recessed 6 Modules

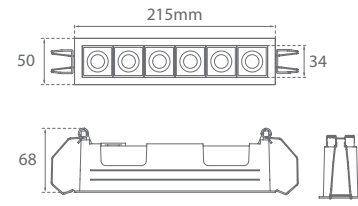

Ocult Downlight
Recessed 9 Modules

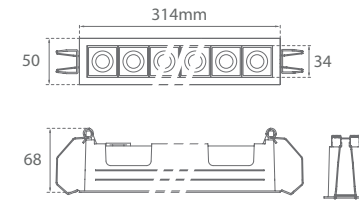

Ocult Downlight
Recessed 12 Modules

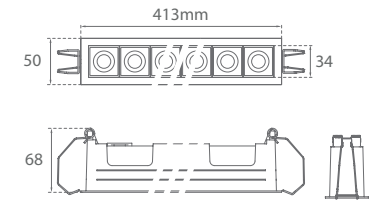

OCULT RECESSED

Family	Installation	Modules	Lm LED	Optic	CRI	K	Gear	Finishes Int.	Finishes Ext.
OD1	RE Recessed	2	04 400lm	MF MFL 24°	8 80	30 3000 K	N ON/OFF	B Black 03	B Black 03
		3	06 600lm	WF WFL 48°			D DALI		W White 03
		6	12 1200lm						
		9	18 1800lm						
		12	22 2400lm						
OD1	RE	2	04	MF	8	30	N	B	B





TECHNICAL CHARACTERISTICS

Optics

MFL 24°

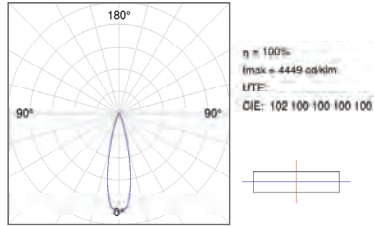

UGR <10
For 4H, 8H 70/ 50 /20

WFL 48°

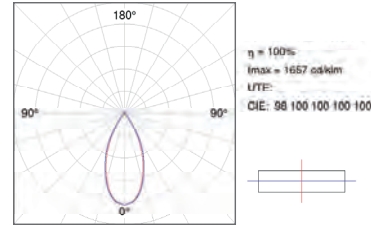

UGR <19
For 4H, 8H 70/ 50 /20

Dimensional data

	2 Modules	3 Modules	6 Modules	9 Modules	12 Modules
XxY	43x74	43x107	43x207	43x307	43x407

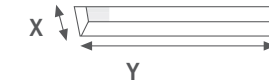

Light output and power

OCULT DOWNLIGHT

	K	CRI	2 Modules		3 Modules		6 Modules		9 Modules		12 Modules	
			W	lm Output	W	lm Output	W	lm Output	W	lm Output	W	lm Output
MFL 24°	3000	80	5	360	8	540	14	1080	20	1620	26,7	2160
	4000	80	5	360	8	540	14	1080	20	1620	26,7	2160
WFL 48°	3000	80	5	366	8	549	14	1098	20	1647	26,7	2196
	4000	80	5	366	8	549	14	1098	20	1647	26,7	2196

ACCESSORIES

Refl ctor (2 modules)



Ref.

ODRF2C
ODRF2M
ODRF2W

Color



Refl ctor (3,6,9,12 modules)



Ref.

ODRF3C
ODRF3M
ODRF3W

Color





Ocult Downlight
Trimless 2 Modules

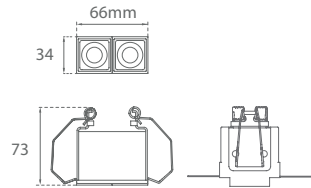

Ocult Downlight
Trimless 3 Modules

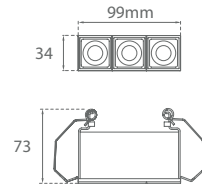

Ocult Downlight
Trimless 6 Modules

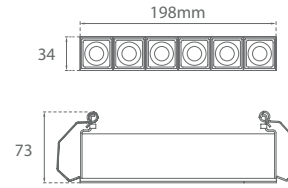

Ocult Downlight
Trimless 9 Modules

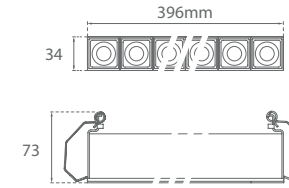

Ocult Downlight
Trimless 12 Modules

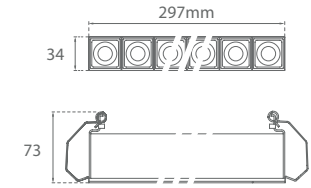

OCULT TRIMLESS

Family	Installation	Modules	Lm LED	Optic	CRI	K	Gear	Finishes Int.
OD1	TR Trimless	2	04 400lm	MF MFL 24°	8 80	30 3000 K	N ON/OFF	B Black 03
		3	06 600lm	WF WFL 48°		40 4000 K	D DALI	
		6	12 1200lm					
		9	18 1800lm					
		12	22 2400lm					
OD1	TR	2	04	MF	8	30	N	B





TECHNICAL CHARACTERISTICS

Optics

MFL 24°

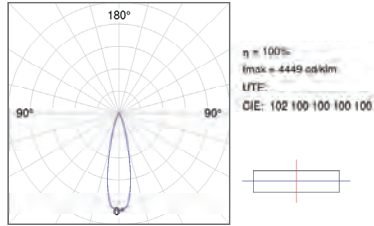

UGR <10
For 4H, 8H 70/ 50 /20

WFL 48°

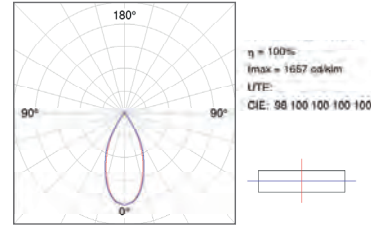

UGR <19
For 4H, 8H 70/ 50 /20

Dimensional data

	2 Modules	3 Modules	6 Modules	9 Modules	12 Modules
XxY	55x74	55x107	55x207	55x307	55x407

Light output and power

OCULT DOWNLIGHT

	K	CRI	2 Modules		3 Modules		6 Modules		9 Modules		12 Modules	
			W	Im Output	W	Im Output	W	Im Output	W	Im Output	W	Im Output
MFL 24°	3000	80	5	360	8	540	14	1080	20	1620	26,7	2160
	4000	80	5	360	8	540	14	1080	20	1620	26,7	2160
WFL 48°	3000	80	5	366	8	549	14	1098	20	1647	26,7	2196
	4000	80	5	366	8	549	14	1098	20	1647	26,7	2196

ACCESSORIES

Refl ctor (2 modules)



Ref.

ODRF2C
ODRF2M
ODRF2W

Color



Refl ctor (3,6,9,12 modules)



Ref.

ODRF3C
ODRF3M
ODRF3W

Color



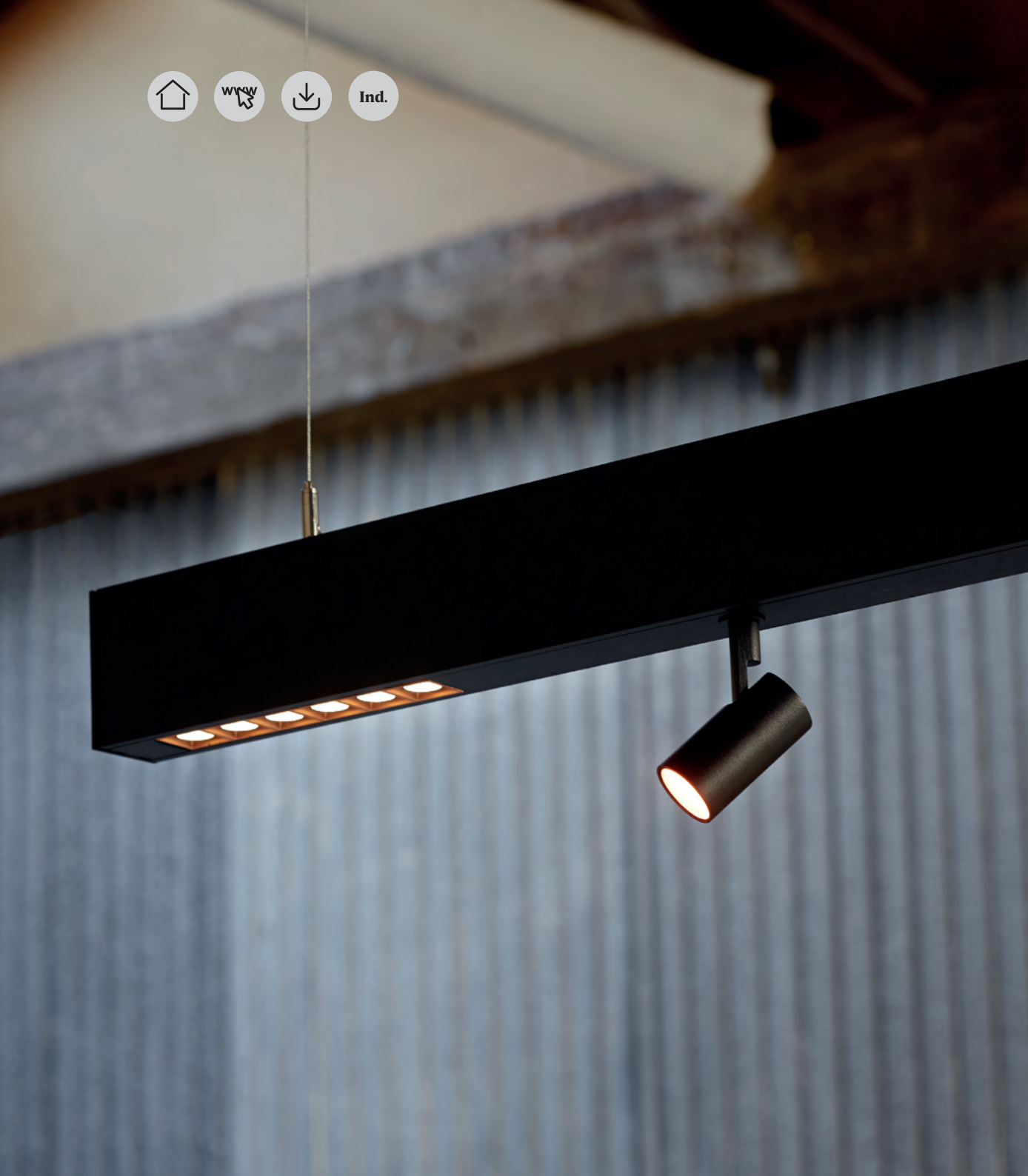

Ocult System



Configuration



Web configurator

1. Installation

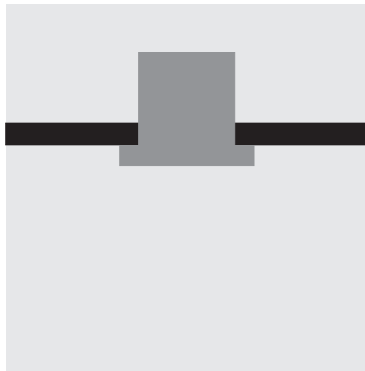

Recessed

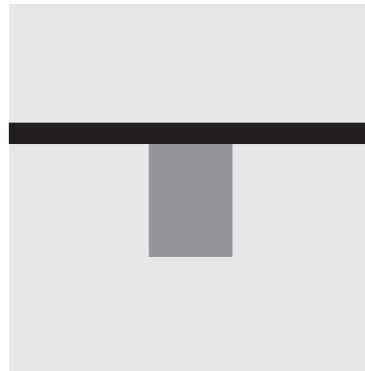

Surface

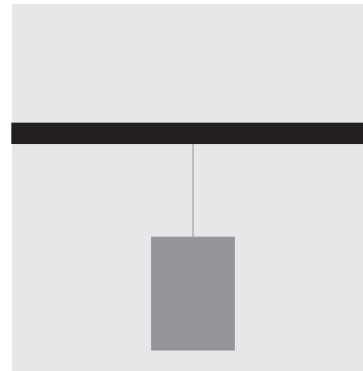

Suspended

2. Format



Linear



Corner

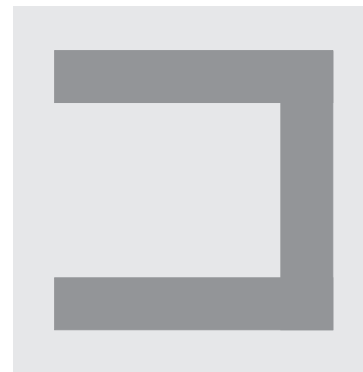

U Format

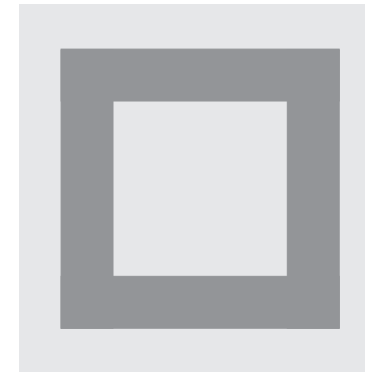

Square



Customizable



3. Light Modules



Downlight



Spotlight

4. Accessories

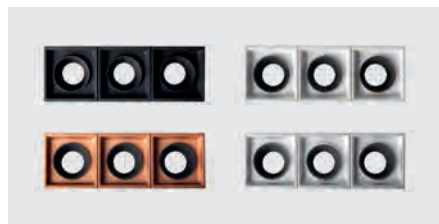

Downlight

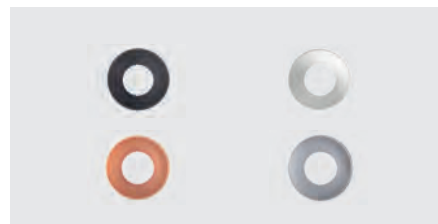

Spotlight

5. Solution

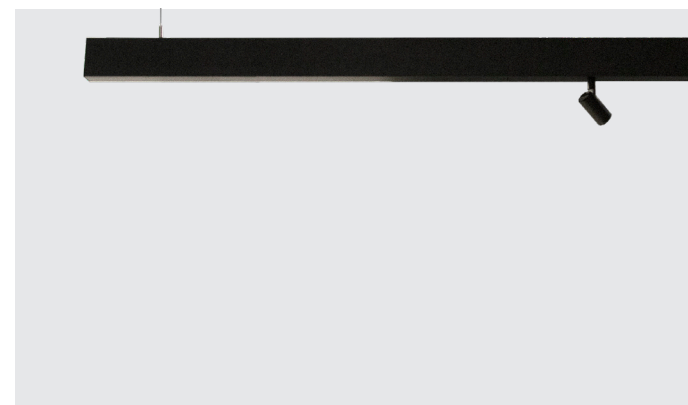



Ocult System Surface Profile

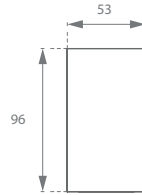

Ocult System Recessed Profile

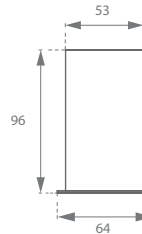

Ocult System Corner

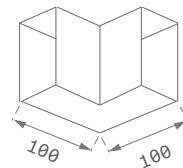

OCULT SYSTEM PROFILE

Family	Installation	Typology	Lengths		Finishes		
OS	SU Surface	PR Profile	500	500mm	B	Black 02	
			600	600mm		W	White 02
	RE Recessed	700	700mm				
		800	800mm				
		900	900mm				
		1000	1000mm				
		1100	1100mm				
		1200	1200mm				
		1300	1300mm				
		1400	1400mm				
	1500	1500mm					
	1600	1600mm					
1700	1700mm						
1800	1800mm						
1900	1900mm						
2000	2000mm						
OS		CO Cover	200	200mm	B	Black 02	
			300	300mm		W	White 02
			400	400mm			
			500	500mm			
			600	600mm			
			700	700mm			
			800	800mm			
900	900mm						
1000	1000mm						
OS	SU Surface	CR Corner ●	100	100x100mm	B	Black 02	
	RE Recessed					W	White 02
OS	SU Surface	EC End Cover			B	Black 02	
	RE Recessed					W	White 02
OS		JO Junction					
OS	SU	PR	500		B		

● Cover and junction accessories included





Ocult System Connectors



OCULT SYSTEM CONNECTORS

Family	Typology	Lengths		Gear	
OS	CTAI Connector	100	100mm	N	ON/OFF
		200	200mm	D	DALI
		300	300mm		
		400	400mm		
		500	500mm		
		600	600mm		
		700	700mm		
		800	800mm		
		900	900mm		
		1000	1000mm		
		1100	1100mm		
		1200	1200mm		
1300	1300mm				
1400	1400mm				
1500	1500mm				
OS	CTAI	100		N	

Height-adjustable steel cable



Ref.	Color	h (mm)
SUWIDE1000G	●	1000
SUWIDE4000G	●	4000

Direct fixing

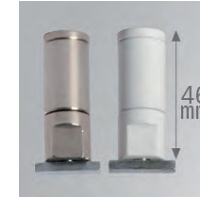

Ref.	Color
SFRG41G	●
SFRG41W	○

Decorative ceiling rose for electrical connection



Ref.	Color	
SUCA4000NW	○	Transparent cable 4m (3x1,5mm) included.
SUCA4000DW	○	Transparent cable 4m (5x1,5mm) included. For regulation.



Ocult System Downlight
3 Modules 600lm

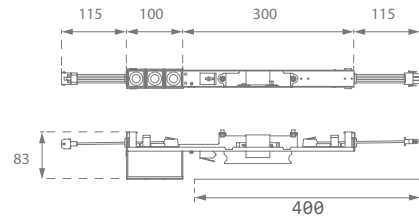

Min. 400mm cover
* Cover not included

Ocult System Downlight
6 Modules 600lm

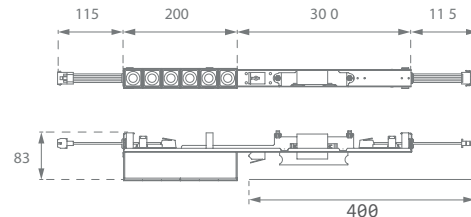

Min. 400mm cover
* Cover not included

Ocult System Downlight
9 Modules 600lm

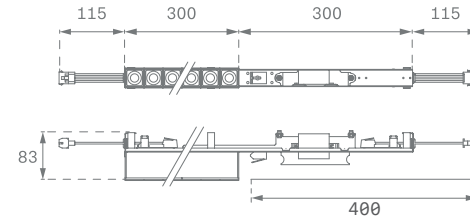

Min. 400mm cover
* Cover not included

Ocult System Downlight
12 Modules 600lm

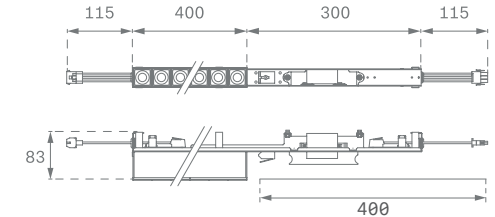

Min. 400mm cover
* Cover not included

OCULT SYSTEM DOWNLIGHT

Family	Typology	Modules	Lm LED	Optic	CRI	K	Gear	Finishes
OS1	DO Downlight	3	06 600lm	MF MFL 24°	8 80	30 3000 K	N ON/OFF	B Black 02
		6	12 1200lm	WF WFL 48°				
		9	18 1800lm					
		12	22 2400lm					
OS1	DO	3	06	MF	8	30	N	B





TECHNICAL CHARACTERISTICS

Optics

MFL 24°

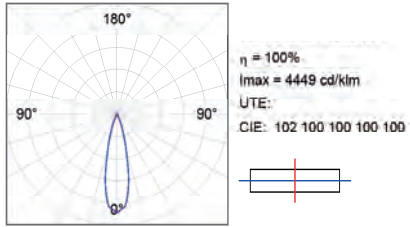

UGR <19
For 4H, 8H 70/ 50 /20

WFL 48°

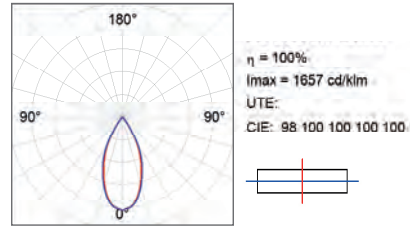

UGR <19
For 4H, 8H 70/ 50 /20

Light output and power

OCULT SYSTEM DOWNLIGHT

			3 MODULES		6 MODULES		9 MODULES		12 MODULES	
	K	CRI	600lm		1200lm		1800lm		2400lm	
			W	lm Output	W	lm Output	W	lm Output	W	lm Output
MFL 24°	3000	80	7,4	540	13,1	1080	20,8	1620	26,9	2160
	4000	80	7,4	540	13,1	1080	20,8	1620	26,9	2160
WFL 48°	3000	80	7,4	549	13,1	1098	20,8	1647	26,9	2196
	4000	80	7,4	549	13,1	1098	20,8	1647	26,9	2196

ACCESSORIES

Reflector (3, 6, 9, 12 modules)



Ref.

- ODRF3W
- ODRF3C
- ODRF3M

Color

-
-
-



Ocult System Spotlight 500lm

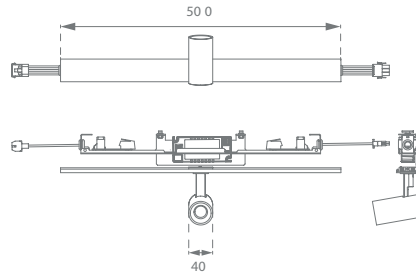

Ocult System Spotlight 1000lm

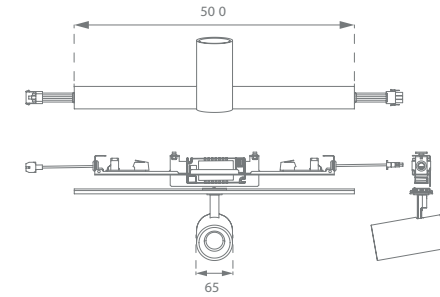

OCULT SYSTEM SPOTLIGHT

Family	Typology	Lm LED	Optic	CRI	K	Gear	Acc. Finishes	Finishes
OS1	SP Spotlight	05 500lm	SP SP 13°	8 80	30 3000 K 40 4000 K	N ON/OFF D DALI	B Black	B Black 02
			MF MFL 19°					W White 05
			FL FL 26°					
OS1	SP Spotlight	10 1000lm	SS SSP 10°	8 80	30 3000 K 40 4000 K	N ON/OFF D DALI	B Black	B Black 02
								W White 05
OS1	SP Spotlight	10 1000lm	SP SP 17°	8 80	30 3000 K 40 4000 K	N ON/OFF D DALI	B Black	B Black 02
			MF MFL 23°					W White 05
			FL FL 37°					
OS1	SP	05	SP	8	30	N	B	B





TECHNICAL CHARACTERISTICS

Optics

SSP 10°

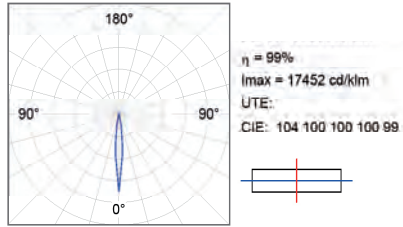

SP 13°-17°

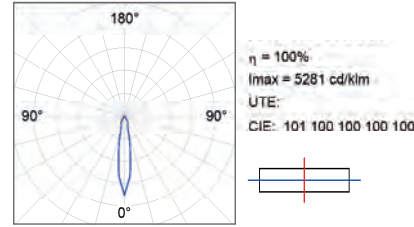

MFL 19-23°

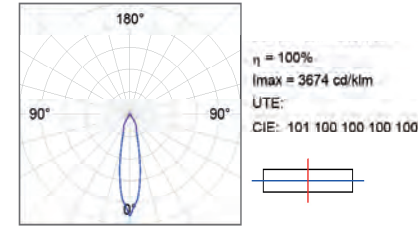

FL 26-37°

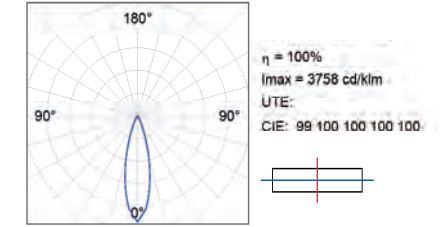

Light output and power

OCULT SYSTEM SPOTLIGHT

	500lm			
	K	CRI	W	lm Output
SP	3000	80	6	314
13°	4000	80	6	339
MFL	3000	80	6	330
19°	4000	80	6	356
FL	3000	80	6	324
26°	4000	80	6	349

	1000lm			
	K	CRI	W	lm Output
SS	3000	80	7,7	498
10°	4000	80	7,7	537
SP	3000	80	7,7	773
17°	4000	80	7,7	819
MFL	3000	80	7,7	806
23°	4000	80	7,7	804
FL	3000	80	7,7	637
37°	4000	80	7,7	738



ACCESSORIES

Transparent diffuser



Lm LED

500
1000/2000

Ref.

[HSTR25](#)
[HSTR50](#)

Refractor for elliptical distribution of luminous flux



Lm LED

500
1000/2000

Ref.

[HSEL25](#)
[HSEL50](#)

Decorative Ring



Lm LED

500
500
500
1000/2000
1000/2000
1000/2000

Ref.

[HSRI40W](#)
[HSRI40C](#)
[HSRI40M](#)
[HSRI65W](#)
[HSRI65C](#)
[HSRI65M](#)

Color





ACCESSORIES

Soft Lens



Lm LED

500
1000/2000

Ref.

[HSSL25](#)
[HSSL50](#)

Anti-glare honeycomb grille



Lm LED

500
1000/2000

Ref.

[HSH025](#)
[HSH050](#)

Buffer



Lm LED

500
1000/2000

Ref.

[HSCU25](#)
[HSCU50](#)



Plat



Plat

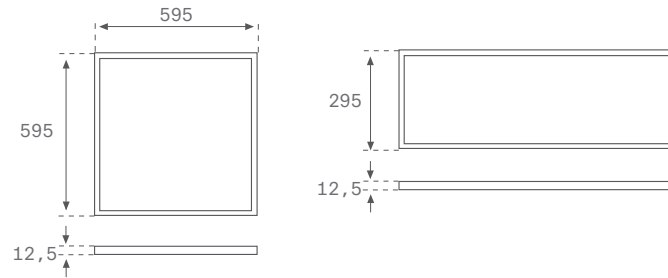

PLAT IP40

Family	Format	Lm LED	Optic	IP	CRI	K	Gear	Finishes
PL3	060 600x600 120 1200x300	35 4100lm	OP Opal	40 IP40	8 80	30 3000 K	N ON/OFF D DALI	W White 06
				54 IP54		40 4000 K		
				PR Prismatic		65 IP65		
					9 90	30 3000 K 40 4000 K		
PL3	060	30	OP	40		30	N	W

PLAT TUNABLE WHITE

Family	Format	Lm	Optic	IP	CRI	K	Gear	Finishes
PL3	060 600x600	35 3500lm	OP Opal	40 IP40	8 80	TW Tunable White	D DALI	W White 06
PL3	060	35	OP	40	8	TW	D	W

PLAT TECH

Family	Format	Lm	Optic	IP	CRI	K	Gear	Finishes
PT1	060 600x600	40 4000lm	TE Tech	40 IP40	9 90	30 3000 K 40 4000 K	N ON/OFF D DALI	W White 06
PL3	060	40	TE	40	9	TW	D	W





TECHNICAL CHARACTERISTICS

Optics

OP

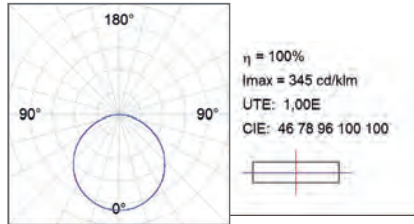

○ Texturised white

PR

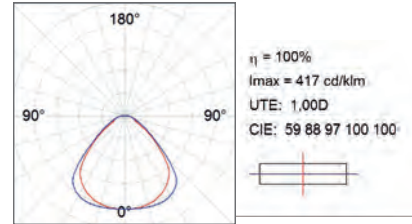

UGR <19
For 4H, 8H 70/ 50 /20

TE

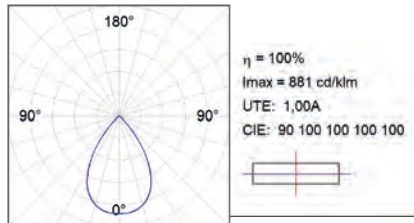

ACCESSORIES

Suspension kit



Ref.	h(m)
PLSUWI1500	max. 1,5m

Frame for PLAT recessed installations



Ref.	Color	mm
PLREFR060	○	600x600x59
PLREFR120	○	1200x300x59

Light output and power

PLAT

	K	CRI	600x600		1200x300	
			W	lm Output	W	lm Output
OP	3000	80	31	3607	31	3607
	4000	80	31	3819	31	3819
	TW	80	36	4495		
PR	3000	80	31	3395	31	3395
		90	31	2900	30	2800
	3500	80	30	3500	30	3500
		90	-	-	-	-
	4000	80	31	3607	31	3607
		90	30	3100	30	3000
TE	3000	90	31	3262		
	4000	90	31	3413		

Frame for PLAT ceiling mounting installations



Ref.	Color	mm
PLSFFR060	○	600x600x59
PLSFFR120	○	1200x300x59



Puzzle

Puzzle
Individual

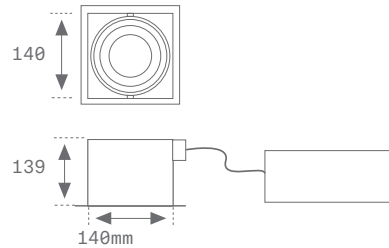

PUZZLE INDIVIDUAL

Family	Installation	Format	Lm LED	Optic	CRI	K	Gear	Finishes
PU2	RE Recessed	1 Individual	15 1400lm 25 2500lm 35 3500lm	MF MFL 26° FL FL 37°	8 80	30 3000 K 40 4000 K	N ON/OFF	W White 02 B Black 02
PU2	RE	1	15	MF	8	30	N	W

TECHNICAL CHARACTERISTICS

Optics

MFL 26°

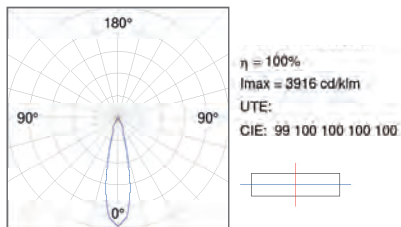

FL 37°

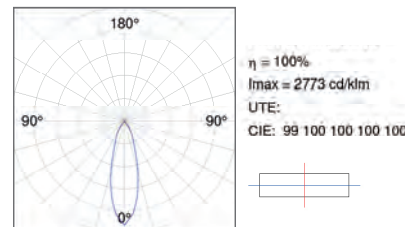

Light output and power

PUZZLE INDIVIDUAL

	K	CRI	1x1400lm		1x2500lm		1x3500lm	
			W	lm Output	W	lm Output	W	lm Output
MFL 26°	3000	80	9,9	1207	19,2	2263	31,4	3103
	4000	80	9,9	1257	19,2	2357	31,4	3232
FL 37°	3000	80	9,9	1168	19,2	2190	31,4	3004
	4000	80	9,9	1217	19,2	2281	31,4	3129



Puzzle
Double

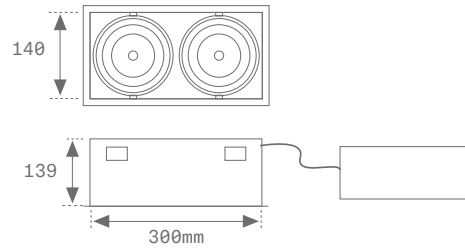

PUZZLE DOUBLE

Family	Installation	Format	Lm LED	Optic	CRI	K	Gear	Finishes
PU2	RE Recessed	2 Double	25 2500lm	MF MFL 26°	8 80	30 3000 K	N ON/OFF	W White 02
			35 3500lm	FL FL 37°		40 4000 K		B Black 02
PU2	RE	2	25	MF	8	30	N	W

TECHNICAL CHARACTERISTICS

Optics

MFL 28°

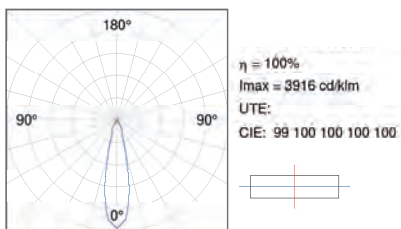

FL 38°

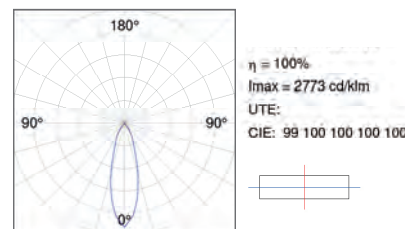

Light output and power

PUZZLE DOUBLE

	K	CRI	2x2500lm		2x3500lm	
			W	lm Output	W	lm Output
MFL 26°	3000	80	38,1	4525	66,6	6205
	4000	80	38,1	4714	66,6	6464
FL 37°	3000	80	38,1	4380	66,6	6008
	4000	80	38,1	4562	66,6	6258



Puzzle
Triple

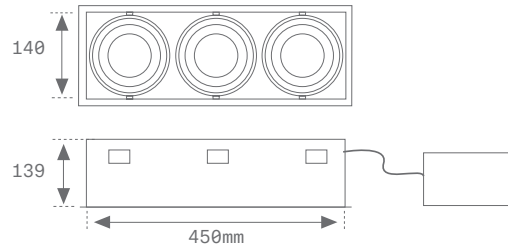

PUZZLE TRIPLE

Family	Installation	Format	Lm LED	Optic	CRI	K	Gear	Finishes
PU2	RE Recessed	3 Triple	25 2500lm 35 3500lm	MF MFL 26° FL FL 37°	8 80	30 3000 K 40 4000 K	N ON/OFF	W White 02 B Black 02
PU2	RE	3	25	MF	8	30	N	W

TECHNICAL CHARACTERISTICS

Optics

MFL 28°

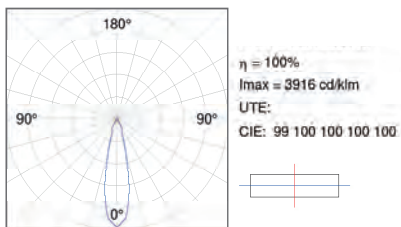

FL 38°

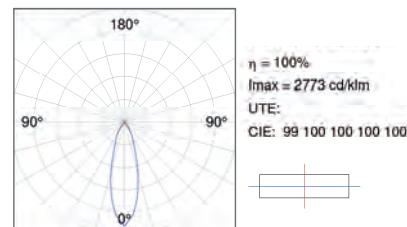

Light output and power

PUZZLE TRIPLE

			3x2500lm		3x3500lm	
	K	CRI	W	lm Output	W	lm Output
MFL	3000	80	57	6788	99,7	9308
	4000	80	57	7071	99,7	9696
FL	3000	80	57	6570	99,7	9012
	4000	80	57	6843	99,7	9387







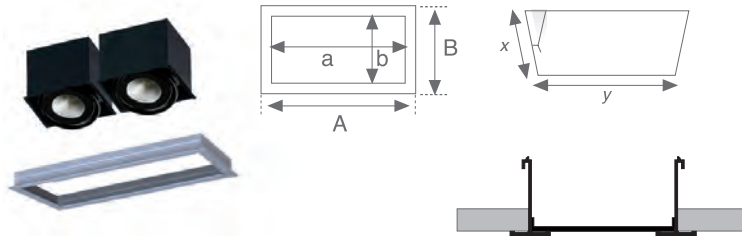

Puzzle Recessed 

Recessed trim frames for Puzzle modules (RE)



PUZZLE FRAMES RECESSED





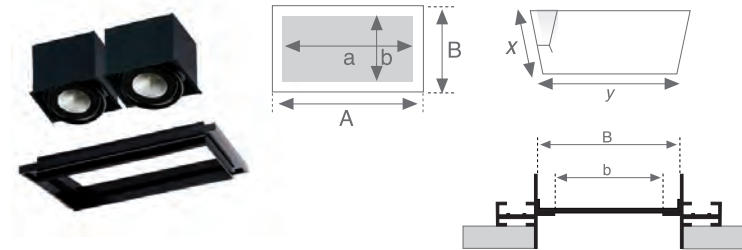

Family	Installation	Typo	Finishes
PU	RE Recessed	FR Frame	W White 04
		1 	
		2 	
		3 	
		4 	
		5 	
		6 	
		9 	
PU	RE	FR	1 W

Puzzle Trimless 







Concealed recessed trim frames for Puzzle modules (TR)



PUZZLE FRAMES TRIMLESS

Family	Installation	Typo	Finishes
PU	TR Recessed	FR Frame	W White 04 B Black 04
		1 	
		2 	
		3 	
		4 	
		5 	
		6 	
		9 	
PU	TR	FR	1 W

Dimensional Data

Kind	A x B	a x b	x x y	Module	Combination
1	186x186	142x142	174x174	A	 1A
2	344x190	300x146	332x178	B	 2A/B
3	494x190	450x146	482x178	C	 3A/A+B/C
4	654x190	610x146	642x178		 A+C/B+B/2A+B/4A
5	959x190	915x146	974x178		 3B/2C
6	1264x190	1220x146	1252x178		 2C+1B
9	344x344	300x300	332x332		 2B

ACCESSORIES

A blind module

	Ref.	Color	Lmm	Kg
	PUCOAB	●	160	0,1
	PUCOAW	○	160	0,1

B blind module

	Ref.	Color	Lmm	Kg
	PUCOBB	●	320	0,2
	PUCOBW	○	320	0,2

90° corner joint (Joints included)

	Ref.	Color
	PUTRFRCB	●
	PUTRFRCW	○

"U" hidden end frame (1 unit for each reference, joints included)

	Ref.	Color
	PUTRFRENB	●
	PUTRFRENW	○

Intermediate joint for hidden frames (2 units for each reference)

	Ref.
	PUTRFRJ0

Hidden frame profile 1 unit for each reference

	Ref.	Color
	PUTRFRPR1000B	●
	PUTRFRPR1000W	○
	PUTRFRPR3000B	●
	PUTRFRPR3000W	○



Ind.

Quiet

Quiet
Baffle Fil 4

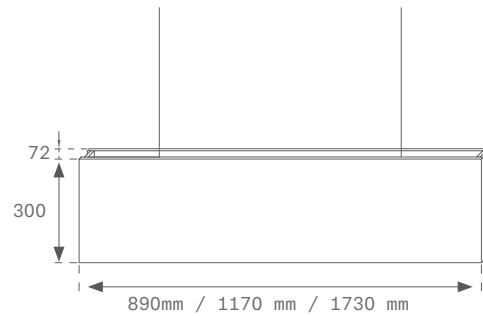

QUIET BAFFLE FIL 45

Family	Format	Lm LED/m	Optic	CRI	K	Gear
QBF41	084 890mm	M0 2320lm	PR Opal Comfort	8 80	30 3000 K	N ON/OFF
	112 1170mm					D DALI
	168 1730mm					
QBF41	084	M0	PR	8	30	N

TECHNICAL CHARACTERISTICS

Optics

PR

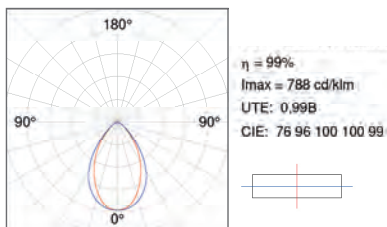

Light output and power

QUIET BAFFLE FIL 45

	K	CRI	840mm		1120mm		1680mm	
			W	lm Output	W	lm Output	W	lm Output
PR	3000	80	15,5	1441	20,9	1922	30,8	2881
	4000	80	15,5	1512	20,9	2017	30,8	3026



Quiet
Round Kombic 100

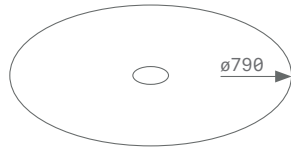

Quiet
Round Kombic 150

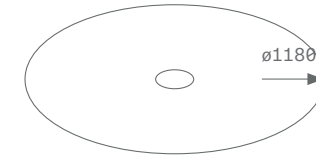

QUIET ROUND S KOMBIC 100

Family	Lm LED	Optic	CRI	K	Gear
QRK11	20 2000lm	OP Opal WF WFL 50°	8 80	30 3000 K 40 4000 K	N ON/OFF D DALI

QRK11	20	OP	8	30	N
--------------	-----------	-----------	----------	-----------	----------

QUIET ROUND L KOMBIC 150

Family	Lm LED	Optic	CRI	K	Gear
QRK21	30 3000lm	OP Opal WF WFL 50°	8 80	30 3000 K 40 4000 K	N ON/OFF D DALI

QRK21	30	OP	8	30	N
--------------	-----------	-----------	----------	-----------	----------





TECHNICAL CHARACTERISTICS

Optics

OP

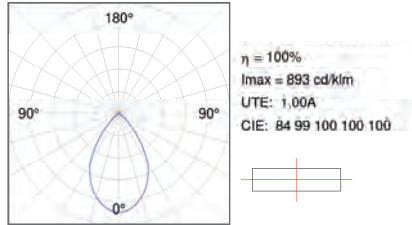

WFL 50°

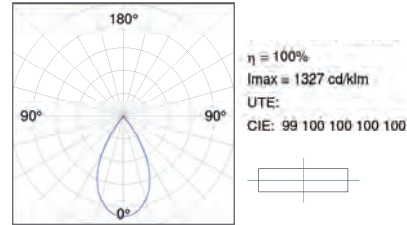

OP

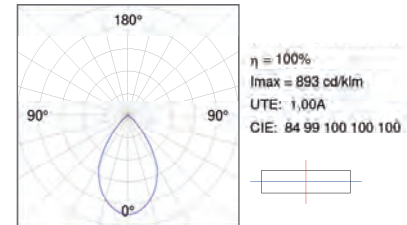

WFL 50°

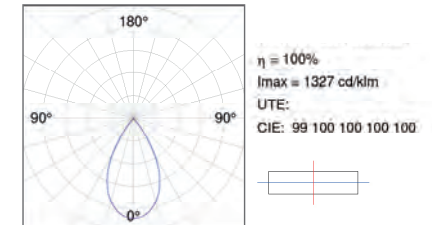

Light output and power

KOMBIC DOWNLIGHT 100 OPAL

2000lm

	K	CRI	W	lm Output
BK	3000	80	13	1460
	4000	80	13	1547
MA	3000	80	13	1392
	4000	80	13	1474
WH	3000	80	13	1454
	4000	80	13	1541

KOMBIC DOWNLIGHT 100 OPTIC

2000lm

	K	CRI	W	lm Output
BK	3000	80	14	1205
	4000	80	14	1277
MA	3000	80	14	1268
	4000	80	14	1343
WH	3000	80	14	1275
	4000	80	14	1351

KOMBIC DOWNLIGHT 150 OPAL

3000lm

	K	CRI	W	lm Output
BR	3000	80	19	2096
	4000	80	19	2184
MA	3000	80	19	2010
	4000	80	19	2094
WH	3000	80	19	2074
	4000	80	19	2161

KOMBIC DOWNLIGHT 150 OPTIC

3000lm

	K	CRI	W	lm Output
BK	3000	80	19	1613
	4000	80	19	1680
MA	3000	80	19	1618
	4000	80	19	1685
WH	3000	80	19	1677
	4000	80	19	1737

Cuts dimensions

	Kombic 100	Kombic 150
∅	D95mm	D145mm



Quiet
Square Ocult

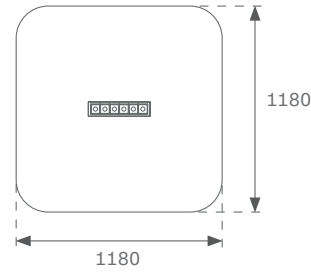

Quiet
Rectangle Ocult

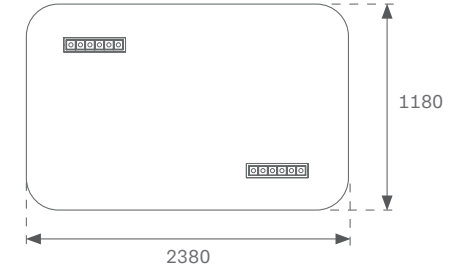

QUIET SQUARE OCULT

Family	Modules	Lm LED	Optic	CRI	K	Gear
QSOD1	06	12 1200lm	MF MFL 24°	8 80	30 3000 K	N ON/OFF
	09	18 1800lm	WF WFL 48°			D DALI
QSOD1	06	12	MF	8	30	N

QUIET RECTANGLE OCULT

Family	Modules	Lm LED	Optic	CRI	K	Gear
QR0D1	26 2x6	24 2400lm	MF MFL 24°	8 80	30 3000 K	N ON/OFF
	29 2x9	36 3600lm	WF WFL 48°			D DALI
QR0D1	26	24	MF	8	30	N





TECHNICAL CHARACTERISTICS

Optics

MFL 24°

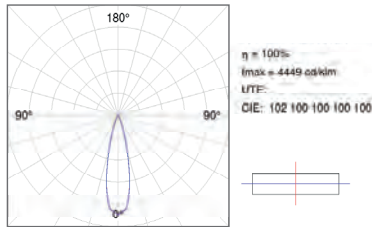

UGR <10
For 4H, 8H 70/ 50 /20

WFL 48°

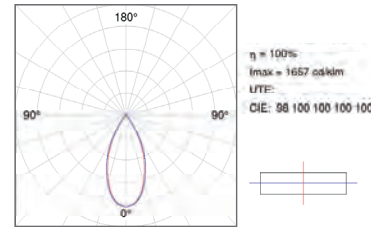

UGR <19
For 4H, 8H 70/ 50 /20

Dimensional data

	6 Modules	9 Modules
XxY	43x207	43x307



Light output and power

QUIET SQUARE OCULT

	K	CRI	6 Modules		9 Modules	
			W	Im Output	W	Im Output
MFL 24°	3000	80	12	1080	18	1620
	4000	80	12	1080	18	1620
WFL 48°	3000	80	12	1098	18	1647
	4000	80	12	1098	18	1647

QUIET RECTANGLE OCULT

	K	CRI	6 Modules		9 Modules	
			W	Im Output	W	Im Output
MFL 24°	3000	80	12	2160	18	3240
	4000	80	12	2160	18	3240
WFL 48°	3000	80	12	2196	18	3294
	4000	80	12	2196	18	3294

ACCESSORIES

Refl ctor (3,6,9,12 modules)



Ref.

- ODRF3C
- ODRF3M
- ODRF3W

Color

-
-
-



Quiet Hexagonal Ocult

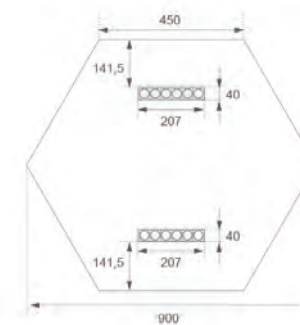
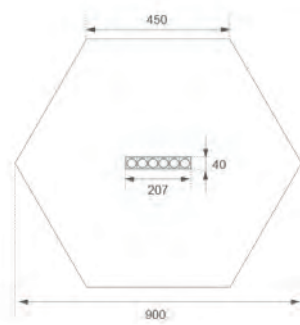

QUIET HEXAGONAL OCULT

Family	Format	Lm LED	Optic	CRI	K	Gear
QHOD1	06 1x6	12 1200lm	MF MFL 24°	8 80	30 3000 K	N ON/OFF
	12 2x6	24 2400lm	WF WFL 48°			D DALI

QHOD1	06	12	PR	8	30	N
--------------	-----------	-----------	-----------	----------	-----------	----------

TECHNICAL CHARACTERISTICS

Optics

MFL 24°

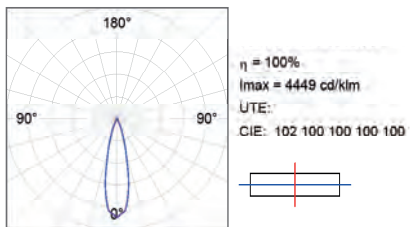

UGR <19
Para 4H, 8H 70/ 50 /20

WFL 48°

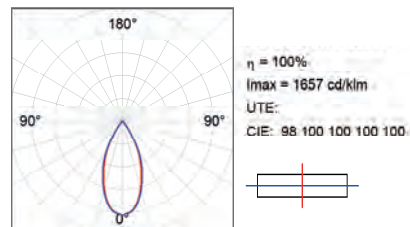

UGR <19
Para 4H, 8H 70/ 50 /20

Light output and power

QUIET HEXAGONAL

	K	CRI	1XOCULT6		2XOCULT6	
			W	lm Output	W	lm Output
MFL	3000	80	14	1080	28	2160
	4000	80	14	1080	28	2160
WFL	3000	80	14	1098	28	2196
	4000	80	14	1098	28	2196



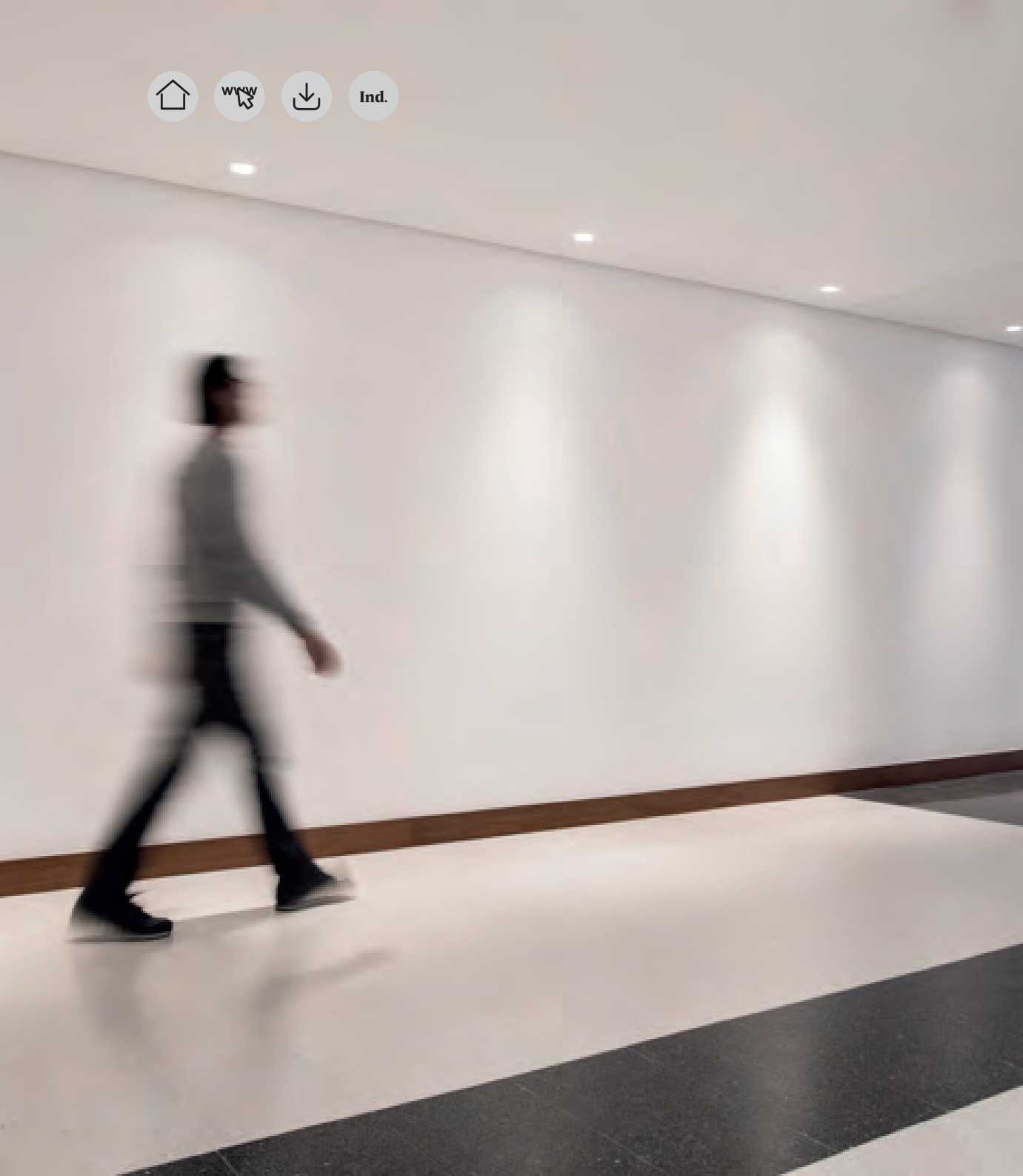

Ring

Ring 90
Round

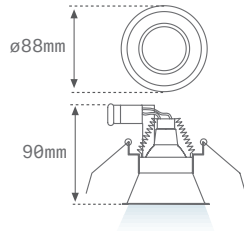

Ring 90
Square

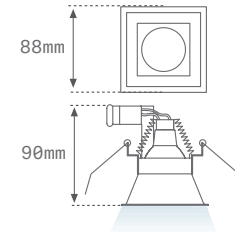

Ring 40
Round

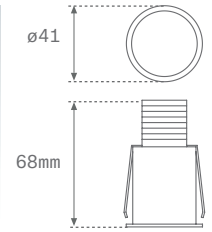

RING

Family	Format	Installation	Lm LED	Optic	CRI	K	Gear	Finishes
RI1	90 88mm	RD Round SQ Square	10 1300	MF MFL 28°	8 80	30 3000 K	T TRIAC	W White 02
	40 40mm	RD Round	02 150	SP SP 10°	9 90	27 2700 K 30 3000 K	N ON/OFF	W White 02 B Black 02
RI1	90	RD	10	MF	8	30	T	W

TECHNICAL CHARACTERISTICS

Optics

ROUND

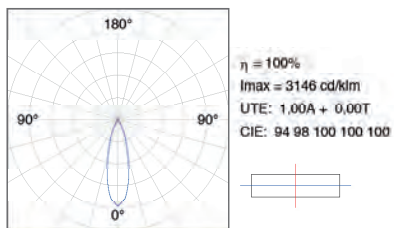

SQUARE

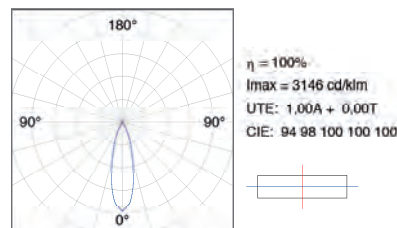

Light output and power

RING 90

	1300lm			
	K	CRI	W	lm Output
MF 28°	3000	80	11,8	971

RING 40

	150lm			
	K	CRI	W	lm Output
WH	2700	90	3,1	114
	3000	90	3,1	131
BK	2700	90	3,1	105
	3000	90	3,1	121



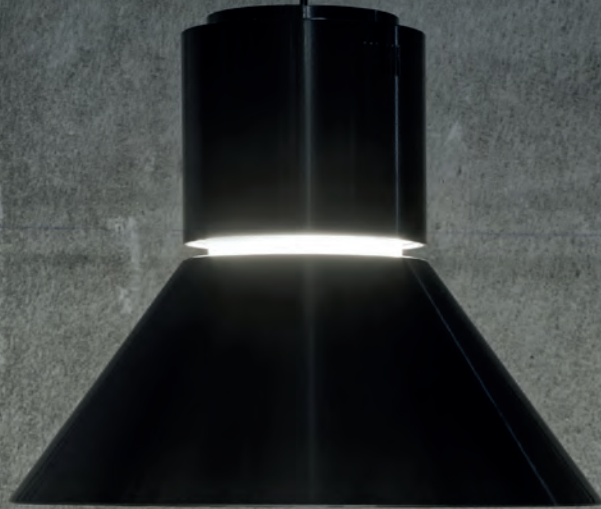

Stormbell



Stormbell

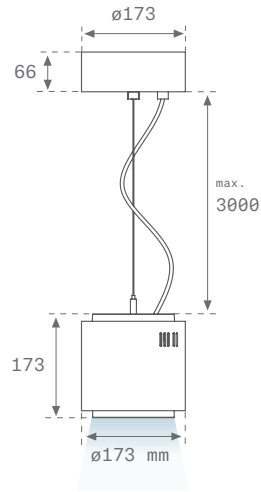

Stormbell Deco

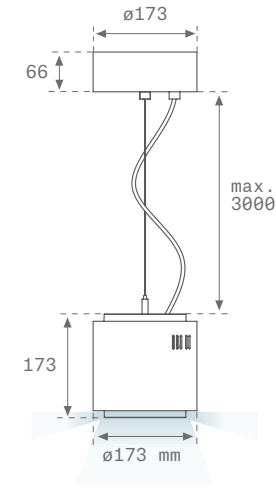

STORMBELL

Family	Format	Lm LED	Optic	CRI	K	Gear	Finishes Int.	Finishes
ST1	170 ø173mm	30 3000lm	FL FL 39°	8 80	30 3000 K	N ON/OFF	B Black 04	W White 04
		50 5000lm	WF WFL 57°					
		80 8000lm						
ST1	170	30	FL	8	30	N	B	W

● Mandatory reflector to use accessories





TECHNICAL CHARACTERISTICS

Optics

FL 39°

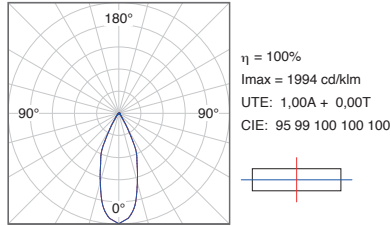

WFL 57°

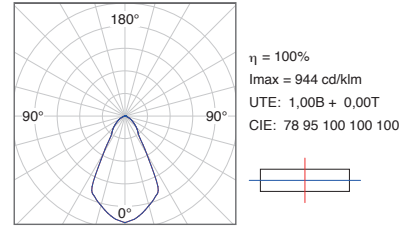

DECO FL 39°

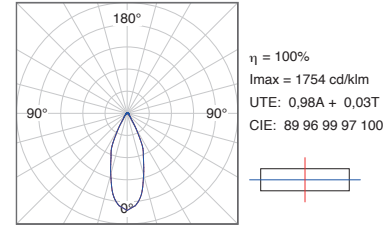

DECO WFL 57°

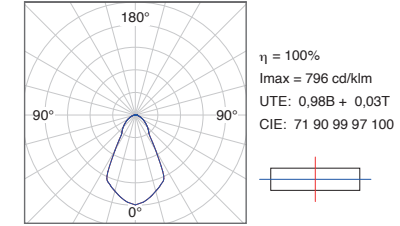

Light output and power

STORMBELL

	K	CRI	3000lm		5000lm		8000lm	
			W	lm Output	W	lm Output	W	lm Output
FL	3000	80	26,3	2402	47,4	3690	68	4884
39°	4000	80	26,3	2468	47,4	3793	68	5000
WFL	3000	80	26,3	2492	47,4	3795	68	5147
57°	4000	80	26,3	2561	47,4	3900	68	5271

STORMBELL DECO

	K	CRI	3000lm		5000lm		8000lm	
			W	lm Output	W	lm Output	W	lm Output
FL	3000	80	26,3	2648	47,4	4152	68	5517
39°	4000	80	26,3	2722	47,4	4267	68	5649
WFL	3000	80	26,3	2985	47,4	4707	68	6371
57°	4000	80	26,3	3068	47,4	4837	68	6524



REFLECTOR

White reflector



Ref.
STBE420W

hmm 173
ø4mm 420

Pict.
850° PC

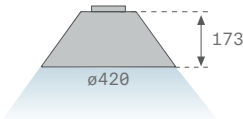

Translucent reflector



Ref.
STBE420P

hmm 173
ø4mm 420

Pict.
850° PC

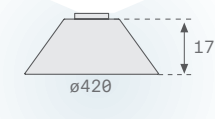

Black reflector



Ref.
STBE420B

hmm 173
ø4mm 420

Pict.
850° PC

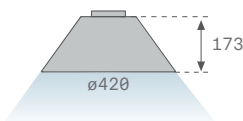

ACCESSORIES

Anti-glare honeycomb grille

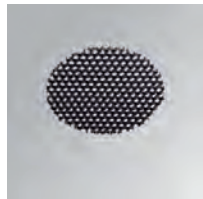

Ref.
STH0102B

ømm 102

Opal glass protector



Ref.
ST1020P

ømm 102

Transparent glass protector



Ref.
ST102TR

ømm 102



Stormbell 80



Stormbell 80
Suspended Recessed

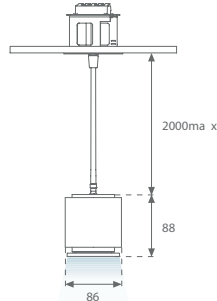

Stormbell 80
Suspended Surface

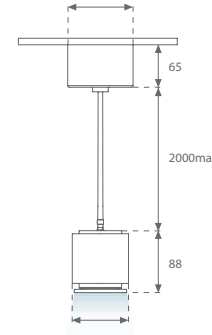

NS Stormbell 80
Suspended Track

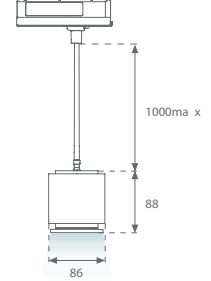

STORMBELL 80 WB

Family	Installation	Lm LED	Optic	CRI	K	Gear	Finishes Ring	Finishes
ST18	SE Sus. Rec.	LO 1500lm	SP SP 15°	9 90	27 2700 K	N ON/OFF	OP Opal	W White
	SS Sus. Sur.		MF MFL 23°		30 3000 K			B Black
	ST Sus. Track		WF WFL 57°		40 4000 K			1 Materiality
					WB3 WB 3000 K			
					WB4 WB 4000 K			
ST18	SE	LO	SP	9	27	N	OP	W

STORMBELL 80 TW

Family	Installation	Lm LED	Optic	CRI	K	Gear	Finishes Ring	Finishes
ST18	SE Sus. Rec.	LO 1500lm	SP SP 25°	9 90	TW Tunable White	D DALI	OP Opal	W White
	SS Sus. Sur.		MF MFL 23°					B Black
	ST Sus. Track		WF WFL 57°					1 Materiality
ST18	SE	LO	SP	9	TW	D	OP	W

● **Mandatory reflector accessory**





TECHNICAL CHARACTERISTICS

Optics

SP

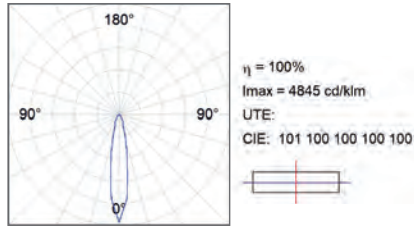

MFL

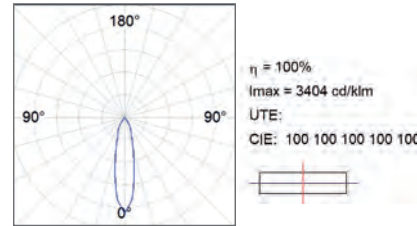

WFL

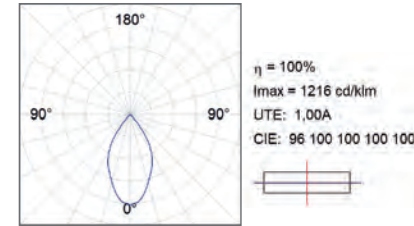

Light output and power

STORMBELL 80

	K	CRI	SU RE		SU SF		SUT	
			W	lm Output	W	lm Output	W	lm Output
SP	2700	90	14,4	1286	14,4	1286	14,4	1286
	3000	90	14,4	1342	14,4	1342	14,4	1342
	4000	90	14,4	1426	14,4	1426	14,4	1426
	3000 WB	98	14,4	1060	14,4	1060	14,4	1060
	4000 WB	98	14,4	1130	14,4	1130	14,4	1130
MFL	2700	90	14,4	1312	14,4	1312	14,4	1312
	3000	90	14,4	1369	14,4	1369	14,4	1369
	4000	90	14,4	1460	14,4	1460	14,4	1460
	3000 WB	98	14,4	1085	14,4	1085	14,4	1085
	4000 WB	98	14,4	1156	14,4	1156	14,4	1156
WFL	2700	90	14,4	1326	14,4	1326	14,4	1326
	3000	90	14,4	1384	14,4	1384	14,4	1384
	4000	90	14,4	1474	14,4	1474	14,4	1474
	3000 WB	98	14,4	1097	14,4	1097	14,4	1097
	4000 WB	98	14,4	1160	14,4	1160	14,4	1160



ACCESSORIES

80x50 reflector



Ref.

S8BE86W
S8BE86B
S8BE86B1

Color

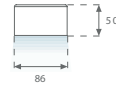

161x150 reflector



Ref.

S8BE161W
S8BE161B
S8BE161B1

Color

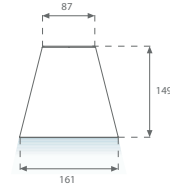

227x89 reflector



Ref.

S8BE227W
S8BE227B
S8BE227B1

Color

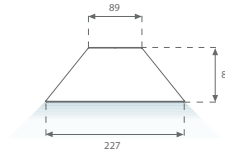

363x60 reflector



Ref.

S8BE363W
S8BE363B
S8BE363B1
S8BE363PT
S8BE363CK

Color

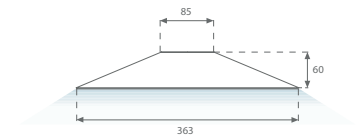

Wellbeing Materiality: 1



1505-Y10R



7024



3010-G



2010-Y20R



3013



Track

Track 48V

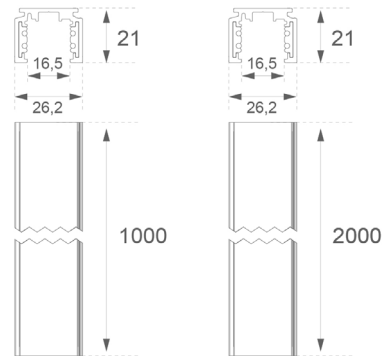

TRACK 48V

Family	Installation	Typology	Length	Gear	Finishes
TL	SU Surface	PR Profile	1000 1000mm 2000 2000mm	DN DALI-ON/OFF	W White 06 B Black 01
TL	SU	PR	1000	D	W

ACCESSORIES













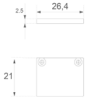

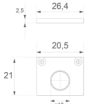
DRIVER

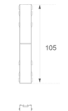
Family	Typology	IP	W	Voltage	Gear
TL	DRV Driver	20 IP 20	70 70W 150 150W	48 48V	N ON/OFF
TL	DRV	20	70	48	N

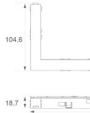

● It is recommended not to exceed 85% of the capacity of the driver.

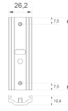
TRACK 48V ACCESORIES

Family	Installation	Typology		Length	Gear	Finishes
TLA	SU Surface	A	Alimentation	 	DN DALI ON-OFF	W White 06 B Black 01
		EC	End cover	 		
		ECC	End cover cable	 		
		UI	Unión	 		
		UL	Connector "L"	 		
		UXJ	Connector "X"	 		
		MJ	Mechanical connection	 	1500 1500mm 3000 3000mm	
		WI1500 WI3000	Suspension wire	 		
TLA	SU	A		1500	D	W

Track 230V







THREE PHASE TRACK

Family	Installation	Typology	Length	Gear	Finishes
TK	RE Recessed	PR Profile	1000 1000mm	DN DALI-ON/OFF	W White
			2000 2000mm		
			3000 3000mm		
	SU Suspended	PR Profile	1000 1000mm	DN DALI-ON/OFF	W White 06
			2000 2000mm		B Black 01
			3000 3000mm		G Grey
TK	RE	PR	1000	DN	W

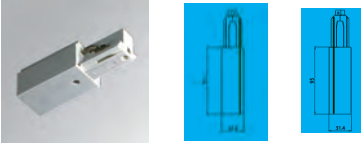
ACCESSORIES

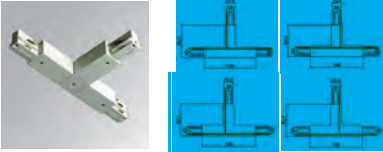
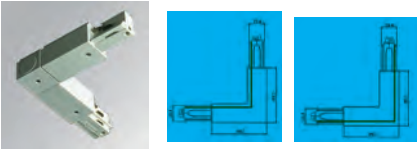
THREE PHASE TRACK ACCESSORIES

Family	Installation	Typology	Defini ion	Gear	Finishes	
TKA		AR Mains Supply Right AL Mains Supply Left			DN DALI-ON/OFF	W White B Black G Grey
		AI Intermediate Joint			DN DALI-ON/OFF	W White B Black G Grey
		TR T Junction Right TL T Junction Left		O Outside I Inner	DN DALI-ON/OFF	W White B Black G Grey
		LI Inner corner LO Outside corner				
		XJ X Joint JU Junction JF Flexible Junction				

TKA







AR

DN

W

ACCESSORIES

THREE PHASE TRACK ACCESSORIES

Family	Installation	Typology	Definition	Gear	Finishes
TKA		EC End Cover			W White B Black G Grey
		CX X Cover			
		CO Decorative Cover (Recessed)			W White B Black G Grey
		SUSSU Suspension Support SRSU Surface Support			W White B Black G Grey
		WI Suspesion Wire		3000 3000mm	
		RG Rigid		1000 1000mm	W White
TKA		EC			W

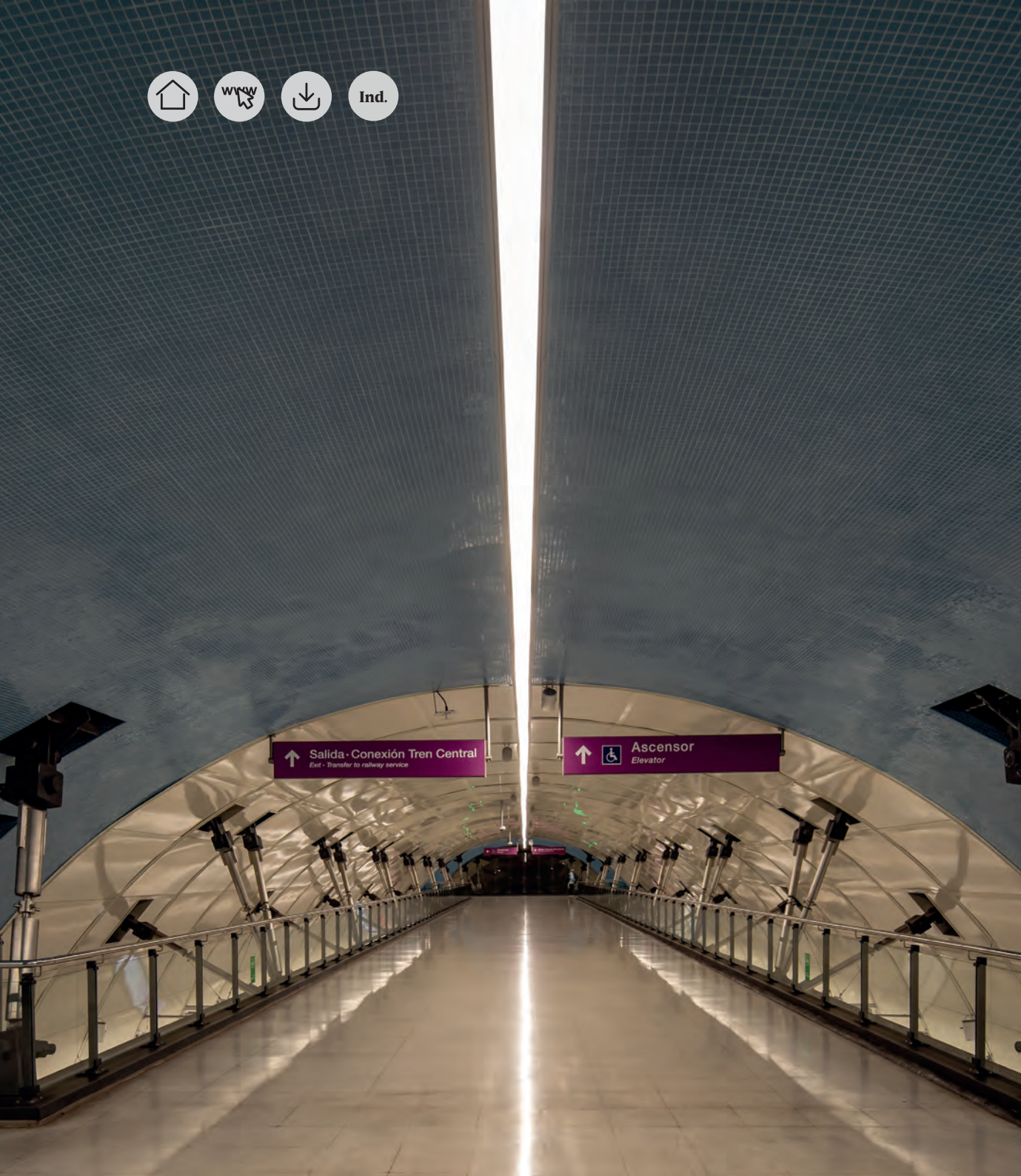

Transit



STGO

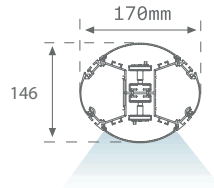

STGO

Family	Format	Lm LED	IP	Optic	CRI	K	Gear	Finishes
ST1	SU Suspended	M0 Medium Output	42 42	OP Opal	8 80	40 4000 K	N ON/OFF	G Grey 01
ST1	SU	M0	42	OP	8	40	N	G

TECHNICAL CHARACTERISTICS

Optics

STGO

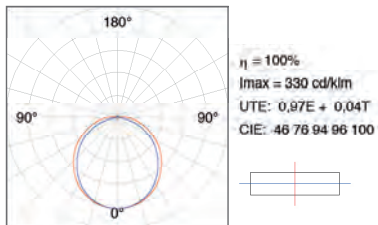

ACCESSORIES

Set of 2 fixings per joint (2 units for each reference)



Ref.

F7J0





TLSE

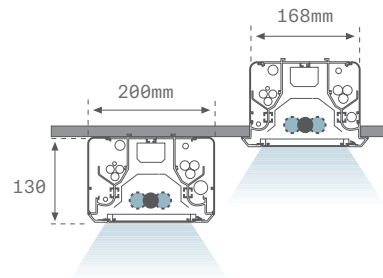

BCN

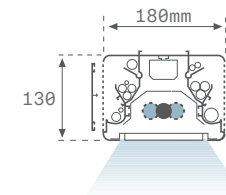

TLSE

Family	Format	Lamps	W	IP	Gear	Finishes
TL1	SF Surface	1 Unit	36 W	20 20	N ON/OFF	W White
TL1	SF	1	36	20	N	W

BCN

Family	Format	Lamps	W	IP	Gear	Finishes
BC1	SU Suspended	1 Unit	36 W	20 20	N ON/OFF	W White
BC1	SU	1	36	20	N	W





TECHNICAL CHARACTERISTICS

Optics

TLSE

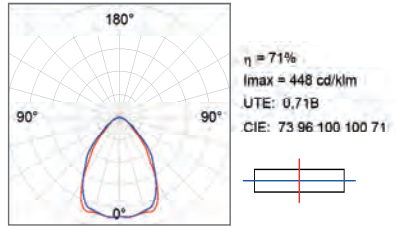

BCN

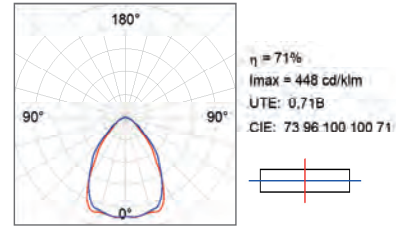

Light output and power

BCN

					6501m
Format	K	CRI	W	lm	Output
OP	4000	80	6	610	

ACCESSORIES

Set of 2 fixings per joint



Ref.

F5J0



Ind.

General Acc. Indoor



SUSPENSIONS: Fil 50, Fil 70, Fil 120, Lamptub (1unit/ref.)

Decorative direct fixing or electrical connection



Ref.	Color
SUCAEMDEW SUCAEMDEG	○ ●

Coupler for 2 rigid suspensions

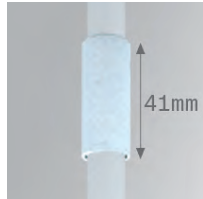

Ref.	Color
SURGJ041W	○

SUSPENSIONS: Fil 35, Fil 45

Height-adjustable steel cable



Ref.	Color	h(mm)
F42SUWIDE1500G F42SUWIDE3000G	● ●	1500 3000

Quick anchorage

Direct fixing

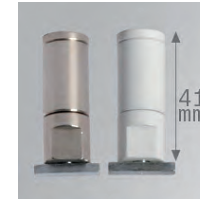

Ref.	Color
SFRG41W SFRG41G	○ ●

Height-adjustable steel cable for electromechanical connection (3 or 5xØ1,5)



Ref.	Color	h(mm)
F42SUCAEMF1500NB F42SUCAEMF1500NW F42SUCAEMF3000NB F42SUCAEMF3000NW	● ○ ● ○	1500 1500 3000 3000
DALI		
F42SUCAEMF1500DB F42SUCAEMF1500DW F42SUCAEMF3000DB F42SUCAEMF3000DW	● ○ ● ○	1500 1500 3000 3000

Quick anchorage



SUSPENSIONS: Fil 35, Fil 45, Fil 50, Fil 70, Fil 120, Lamptub (1unit/ref.)

Recessed Basic Ceiling rose

	Ref.	Color	h(mm)
	SUCAREBA1500NB	●	1500
	SUCAREBA1500NW	○	1500
	SUCAREBA3000NB	●	3000
	SUCAREBA3000NW	○	3000
	DALI		
	SUCAREBA1500DB	●	1500
	SUCAREBA1500DW	○	1500
	SUCAREBA3000DB	●	3000
SUCAREBA3000DW	○	3000	

Surface Basic Ceiling rose

	Ref.	Color	h(mm)
	SUCASFBA1500NB	●	1500
	SUCASFBA1500NW	○	1500
	SUCASFBA3000NB	●	3000
	SUCASFBA3000NW	○	3000
	DALI		
	SUCASFBA1500DB	●	1500
	SUCASFBA1500DW	○	1500
	SUCASFBA3000DB	●	3000
SUCASFBA3000DW	○	3000	

Recessed Deco Ceiling rose

	Ref.	Color	h(mm)
	SUCAREDE1500NB	●	1500
	SUCAREDE1500NW	○	1500
	SUCAREDE3000NB	●	3000
	SUCAREDE3000NW	○	3000
	DALI		
	SUCAREDE1500DB	●	1500
	SUCAREDE1500DW	○	1500
	SUCAREDE3000DB	●	3000
SUCAREDE3000DW	○	3000	

Surface Deco Ceiling rose

	Ref.	Color	h(mm)
	SUCASFDE1500NB	●	1500
	SUCASFDE1500NW	○	1500
	SUCASFDE3000NB	●	3000
	SUCASFDE3000NW	○	3000
	DALI		
	SUCASFDE1500DB	●	1500
	SUCASFDE1500DW	○	1500
	SUCASFDE3000DB	●	3000
SUCASFDE3000DW	○	3000	

SUSPENSIONS: Fil 50, Fil 70

Height-adjustable steel cable

	Ref.	Color	h(mm)
	F52SUWIDE1500G	●	1500
	F52SUWIDE3000G	●	3000
Quick anchorage			

SUSPENSIONS: Fil 120, BCN, STGO (1unit/ref.)

Two steel cables electromechanical suspension

	Ref.	Color	h(m)
	SUEM2W3000NW	○	max. 3
	SUEM2W3000NG	●	max. 3



Height-adjustable steel cable for electromechanical connection (3 or 5xØ1,5)



Ref.	Color	h(mm)
F42SUCAEMF1500NB	●	1500
F42SUCAEMF1500NW	○	1500
F42SUCAEMF3000NB	●	3000
F42SUCAEMF3000NW	○	3000
DALI		
F42SUCAEMF1500DB	●	1500
F42SUCAEMF1500DW	○	1500
F42SUCAEMF3000DB	●	3000
F42SUCAEMF3000DW	○	3000

Anclaje desde el extremo

WALL: Fil 50, Fil 70, Fil 120, Lamptub (1unit/ref.) Unión soporte

Short wall bracket 2 unit/ref.



Ref.	Color
F5FX75W	○
F5FX75G	●

Adjustable and extensible wall bracket 2 unit/ref.



Ref.	Color
ARROEX40W	○
ARROEX40G	●

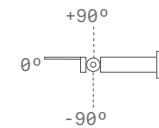

Adjustable wall bracket 2 unit/ref.

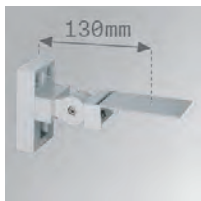

Ref.	Color
ARRO13W	○

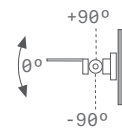



B-Side



B-Side
135

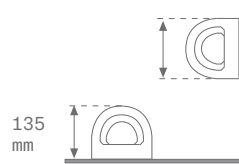

B-Side
450

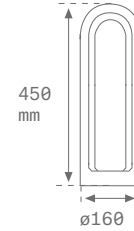

B-Side
850

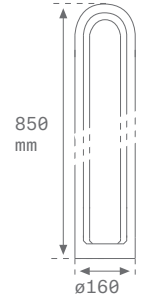

B-SIDE

Family	Format	Dimension	Lm LED	CRI	K	Gear	Finishes
BS1	DB Double	13 135mm	03 250lm	8 80	40 4000 K	N ON/OFF	G Grey 03 A Anthracite 01
		45 450mm	03 250lm				
		85 850mm	05 500lm				
BS1	DB	13	03	8	40	N	G

TECHNICAL CHARACTERISTICS

Optics

135

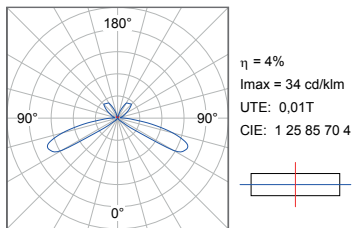

450

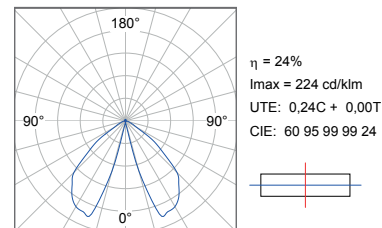

850

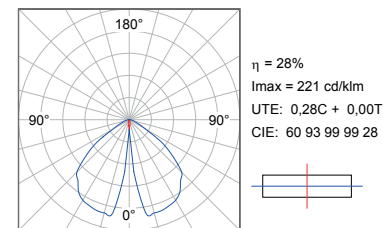

Light output and power

B-SIDE

Model	K	CRI	250lm		500lm	
			W	lm Output	W	lm Output
135	4000	80	3,5	138	-	-
450	4000	80	4,5	112	6,4	130
850	4000	80	4,5	112	6,4	171



B-Side 360°
250

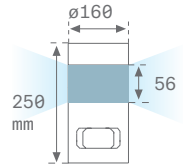

B-Side 360°
450

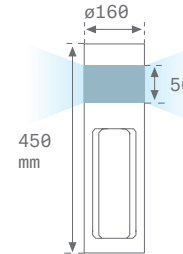
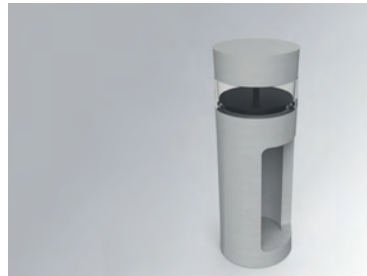

B-Side 360°
850

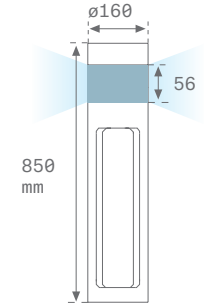
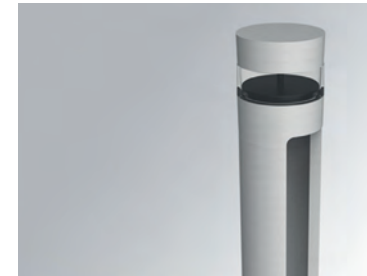

B-SIDE 360°

Family	Format	Dimension	Lm LED	CRI	K	Gear	Finishes
BS2	36 360°	25 250mm	10 1200lm	8 80	30 3000 K 40 4000 K	N ON/OFF	G Grey 03
		45 450mm					A Anthracite 01
		85 850mm					
		85 850mm	15 1500lm				
BS2	36	25	10	8	40	N	G

TECHNICAL CHARACTERISTICS

Optics

250

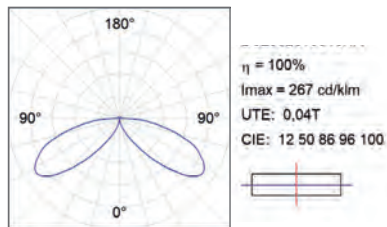

450

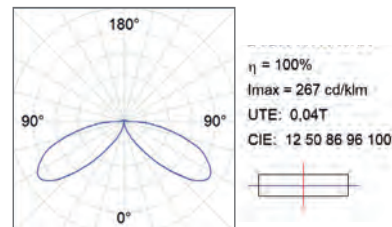

850

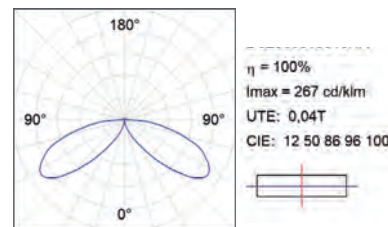

Light output and power

B-SIDE 360°

Model	K	CRI	1200lm		1500lm	
			W	lm Output	W	lm Output
235	3000	80	8,7	530	9,9	608
450	4000	80	8,7	560	9,9	644
850						



B-Side 180°
250

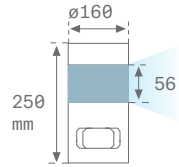

B-Side 180°
450

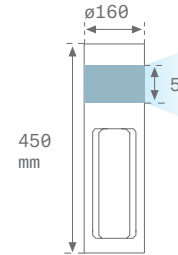
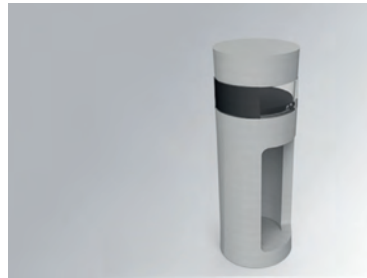

B-Side 180°
850

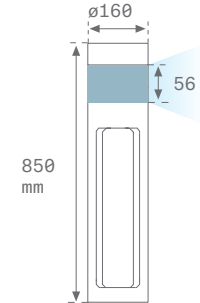
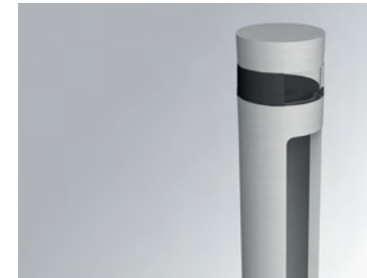

B-SIDE 360°

Family	Format	Format (L)	Lm LED	CRI	K	Gear	Finishes
BS2	18 180°	25 250mm	10 1200lm	8 80	30 3000 K 40 4000 K	N ON/OFF	G Grey 03 A Anthracite 01
		45 450mm					
		85 850mm					
		85 850mm	15 1500lm				
BS2	18	25	10	8	40	N	G

TECHNICAL CHARACTERISTICS

Optics

Light output and power

250

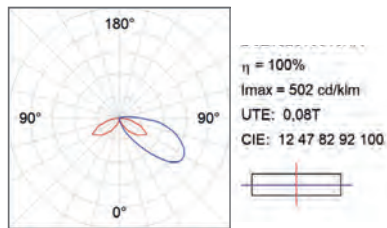

450

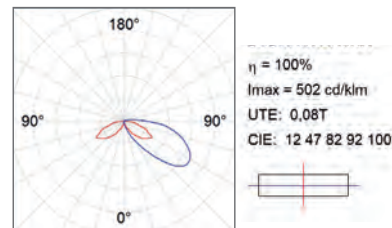

850

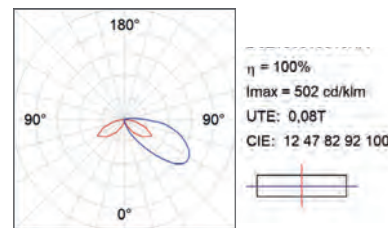

B-SIDE 180°

Model	K	CRI	1200lm		1500lm	
			W	lm Output	W	lm Output
250	3000	80	8,7	350	9,9	405
450	4000	80	8,7	370	9,9	429
850						





Bauline



Bauline
Recessed

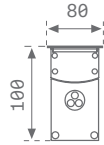

Bauline
Surface

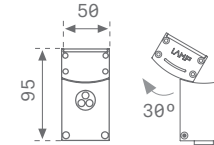

BAULINE

Family	Installation	Length	Lm LED/m	Optic	CRI	K	Gear	Finishes
BA3	RE Recessed	068 680mm	MO 3900lm/m	SP SP 13° MF MFL 21° EL Elliptic	8 80	30 3000 40 4000	N ON/OFF	G Grey 02
		127 1270mm						
	SF Surface	065 650mm 124 1240mm						
BA3	RE	068	MO	SP	8	30	N	G





TECHNICAL CHARACTERISTICS

Optics

SP 13°

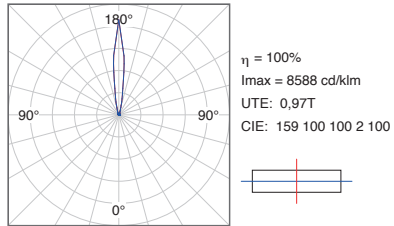

MFL 21°

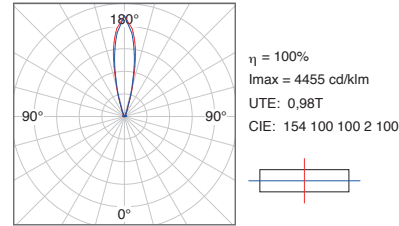

EL

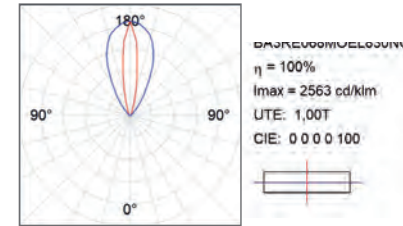

Light output and power

BAULINE RECESSED

	K	CRI	680mm		1270mm	
			W	lm Output	W	lm Output
SP 13°	3000	80	16,2	1916	32,3	3921
	4000	80	16,2	1916	32,3	3921
MFL 21°	3000	80	16,2	1996	32,3	3994
	4000	80	16,2	1996	32,3	3994
EL	3000	80	16,2	1916	32,3	3832
	4000	80	16,2	1916	32,3	3832

BAULINE SURFACE

	K	CRI	650mm		1240mm	
			W	lm Output	W	lm Output
SP 13°	3000	80	16,2	1937	32,3	3873
	4000	80	16,2	1937	32,3	3873
MFL 21°	3000	80	16,2	1972	32,3	3945
	4000	80	16,2	1972	32,3	3945
EL	3000	80	16,2	1916	32,3	3832
	4000	80	16,2	1916	32,3	3832



ACCESSORIES

BAULINE recessing box with gear



Ref.

BUREB00683
BUREB01272

Lmm

683
1272

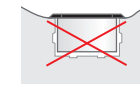
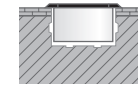
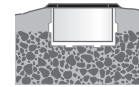
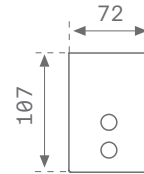

Avoid its placing in ground depression
Mandatory drainage

ACCESSORIES surface

Adjustable wall bracket (2 units for each reference)



Ref.

WAAR120G

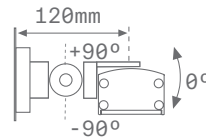

Adjustable and extensibe wall bracket (2 units for each reference)



Ref.

WAAR380G

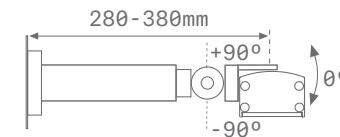

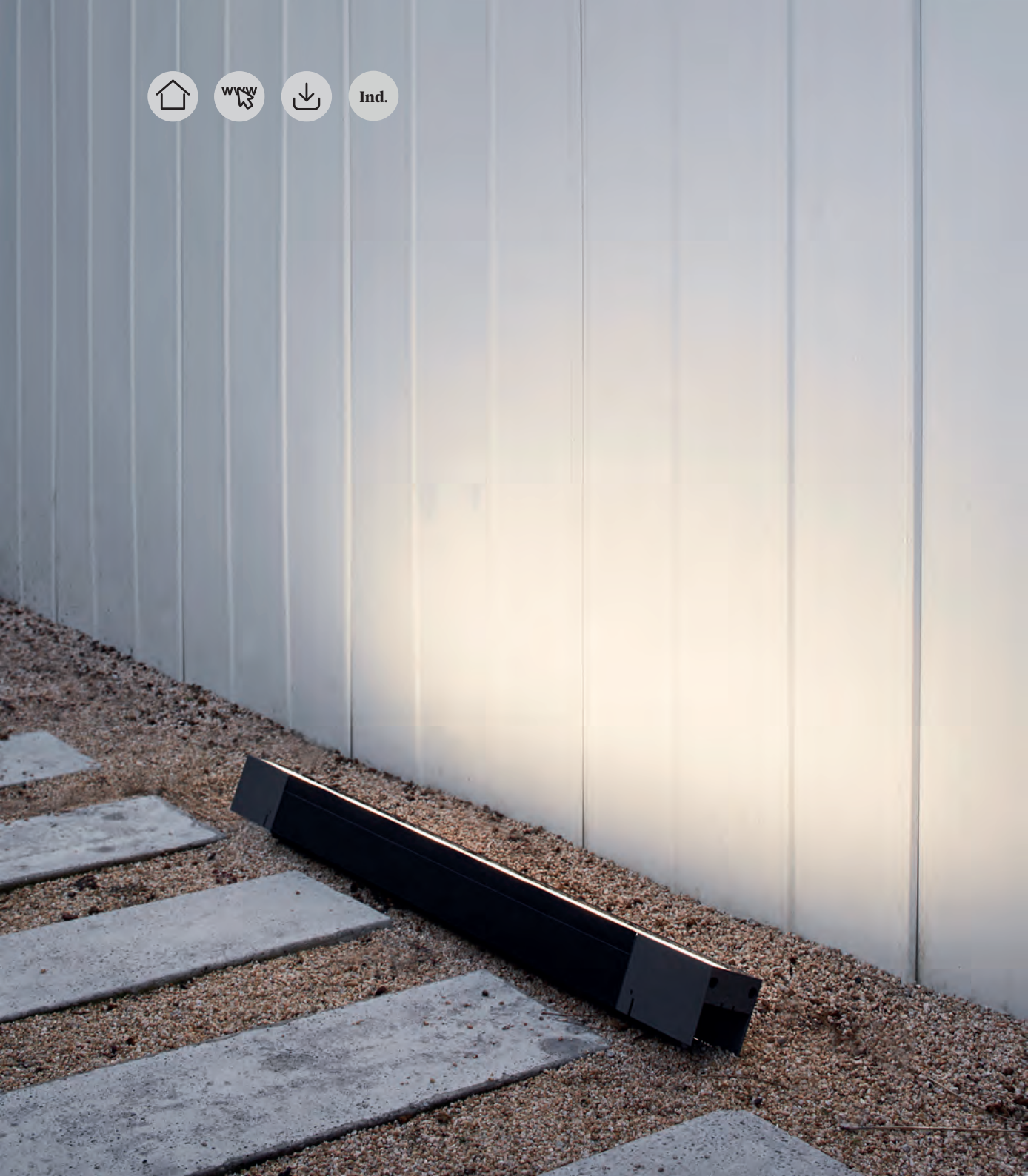

Bazz



Bazz
Symmetric

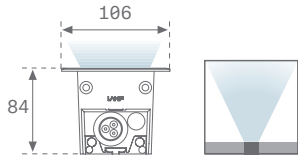

Bazz
Asymmetric

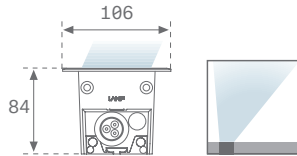

Bazz
Wall Washer

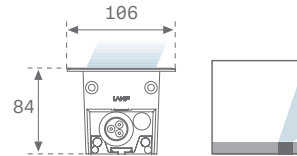

Bazz
Opal

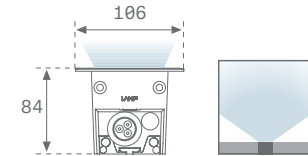
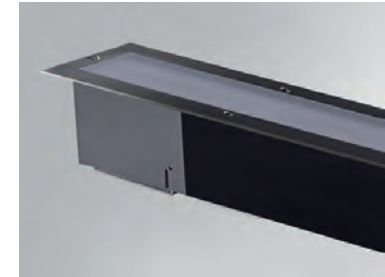

BAZZ SYMMETRIC ASYMMETRIC

Family	Installation	Format	Lm LED	Optic	CRI	K	Gear	Finishes
BZ1	RE Recessed	100 1043mm	LO 2800lm	SY Symmetric	8 80	30 3000 K	N ON/OFF	B Black 06
		200 2036mm	MO 5600lm	AS Asymmetric				
BZ1	RE	100	LO	SY	8	30	N	B

BAZZ WALL WASHER

Family	Installation	Format	Lm LED	Optic	CRI	K	Gear	Finishes
BZ1	RE Recessed	100 1043mm	MO 4200lm	WW Wall Washer	8 80	30 3000 K	N ON/OFF	B Black 06
		200 2036mm						
BZ1	RE	100	MO	WW	8	30	N	B

BAZZ OPAL

Family	Installation	Format	Lm LED	Optic	CRI	K	Gear	Finishes
BZ1	RE Recessed	100 1043mm	MO 4200lm	OP Opal	8 80	30 3000 K	N ON/OFF	B Black 06
		200 2036mm						
BZ1	RE	100	MO	OP	8	30	N	B





TECHNICAL CHARACTERISTICS

Optics

SYMMETRIC

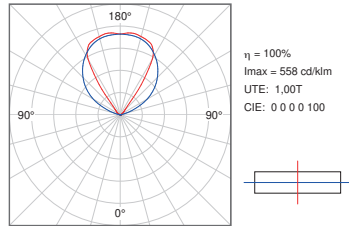

ASYMMETRIC

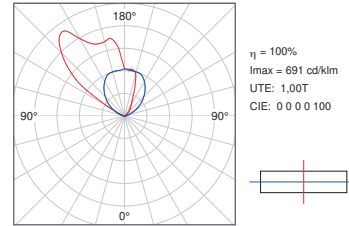

WALL WASHER

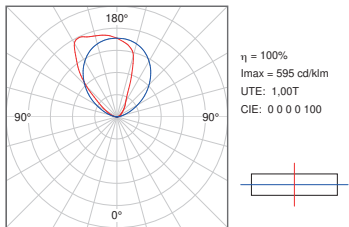

OPAL

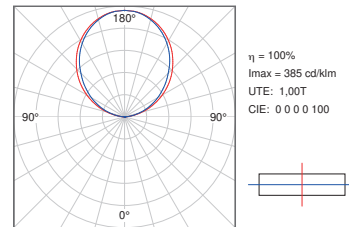

Light output and power

BAZZ RECESSED

				1000mm		2000mm	
		K	CRI	W	lm Output	W	lm Output
LO	SY	3000	80	20,6	2047	40	4094
		4000	80	20,6	2149	40	4299
	AS	3000	80	20,6	1981	40	3962
		4000	80	20,6	2080	40	4160
MO	SY	3000	80	40	4024	77	8048
		4000	80	40	4225	77	8450
	AS	3000	80	40	3883	77	7766
		4000	80	40	4077	77	8158
	WW	3000	80	40	2572	77	5144
		4000	80	40	2701	77	5401
	OP	3000	80	34,8	1528	66	3056
		4000	80	34,8	1604	66	3209

ACCESSORIES

BAZZ recessing box



Ref.

BZREB01000
BZREB02000

Lmm

1035
 2028

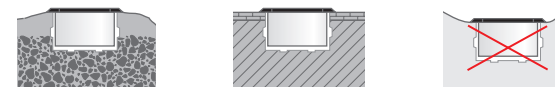
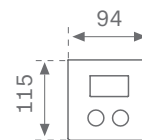

Avoid its placing in ground depression
 Mandatory drainage

IP68 3 poles connector



Ref.

CT3P680
CT3P68G

Color



ømm

8-10
 6,5-12



Bazz Air
Symmetric

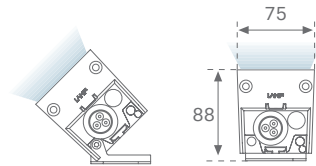

Bazz Air
Asymmetric

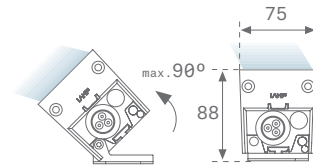
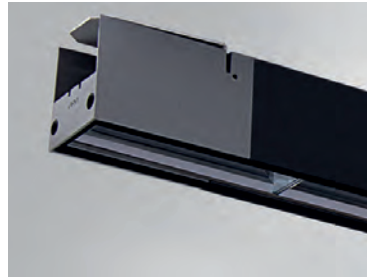

Bazz Air
Wall Washer

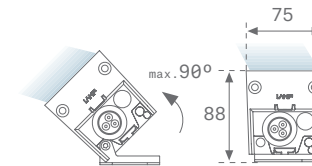
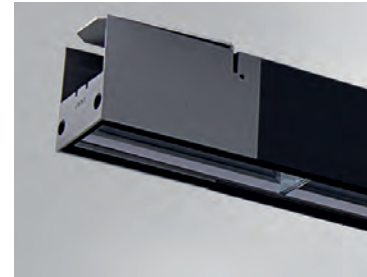

Bazz Air
Opal

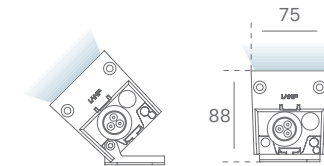

BAZZ AIR SYMMETRIC ASYMMETRIC

Family	Installation	Format	Lm LED	Optic	CRI	K	Gear	Finishes
BZ1	SF Surface	100 1008mm	LO 2800lm	SY Symmetric	8 80	30 3000 K	N ON/OFF	B Black 06
		200 2001mm	MO 5600lm	AS Asymmetric				
BZ1	SF	100	LO	SY	8	30	N	B

BAZZ AIR WALL WASHER

Family	Installation	Format	Lm LED	Optic	CRI	K	Gear	Finishes
BZ1	SF Surface	100 1008mm	MO 4200lm	WW Wall Washer	8 80	30 3000 K	N ON/OFF	B Black 06
		200 2001mm						
BZ1	SF	100	MO	WW	8	30	N	B

BAZZ AIR OPAL

Family	Installation	Format	Lm LED	Optic	CRI	K	Gear	Finishes
BZ1	SF Surface	100 1008mm	MO 4200lm	OP Opal	8 80	30 3000 K	N ON/OFF	B Black 06
		200 2001mm						
BZ1	SF	100	MO	OP	8	30	N	B





TECHNICAL CHARACTERISTICS

Optics

SYMMETRIC

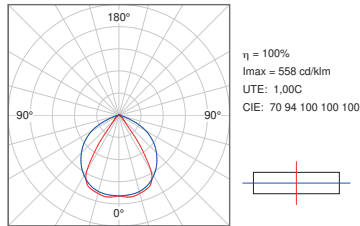

ASYMMETRIC

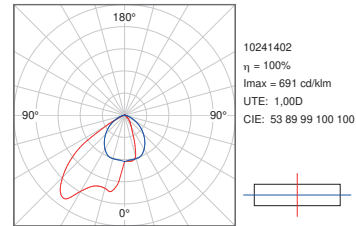

WALL WASHER

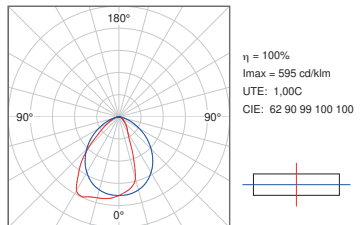

OPAL

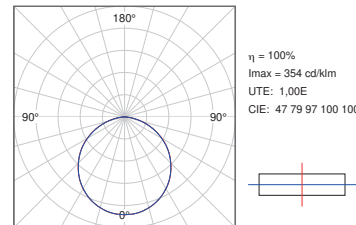

Light output and power

BAZZ AIR

				1000mm		2000mm	
		K	CRI	W	lm Output	W	lm Output
LO	SY	3000	80	20,6	2010	40	4020
		4000	80	20,6	2111	40	4221
	AS	3000	80	20,6	1945	40	3891
		4000	80	20,6	2043	40	4089
MO	SY	3000	80	40	4020	77	7903
		4000	80	40	4221	77	8289
	AS	3000	80	40	2891	77	7626
		4000	80	40	4089	77	8008
	WW	3000	80	40	2526	77	5051
		4000	80	40	2652	77	5304
	OP	3000	80	35	1490	66	2980
		4000	80	35	1565	66	3129

ACCESSORIES

Continous line joint



Ref.

BZJ0

BAZZ aluminium clamps for Ø 120-130mm pole



Ref.

BZSFCL1
BZSFCL2

Color



Kg

1,65 1 Bazz
2,20 2 Bazz

Height-adjustable steel cable 1 unit. / ref. Are needed 2 unit. / lum.

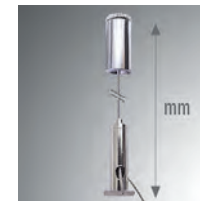

Ref.

SUWIDE1000G
SUWIDE4000G

mm

1000
4000

Adjustable and extensibe wall bracket 2 unit. / ref.



Ref.

ARR0EX40G

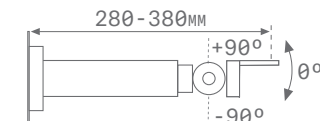



Duit

Configuration









1. Light Engine

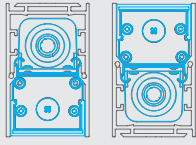

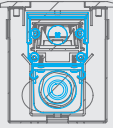
Driver

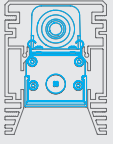

2. Installation accessories

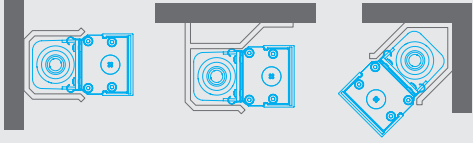
Basic	Surface		
	Recessed		
	Recessed Asymmetric		
Integration	Trimless		
	Surface		



3. Optic Accessories

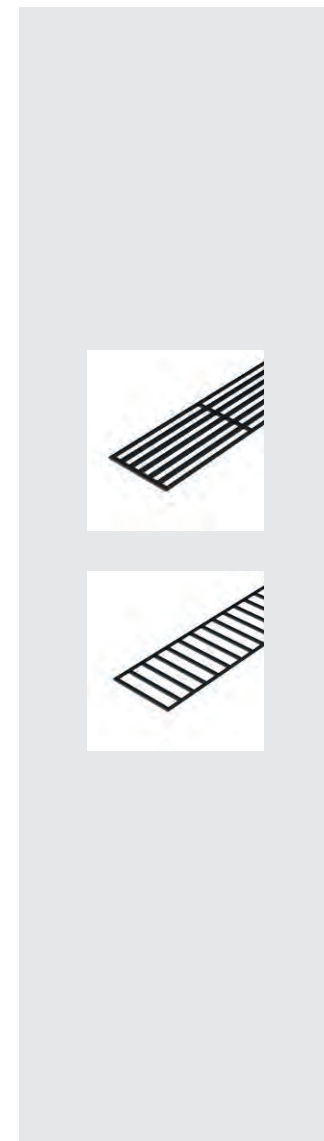

Duit Light Engine Ambient

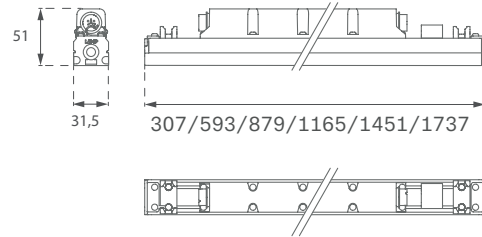

Duit Light Engine

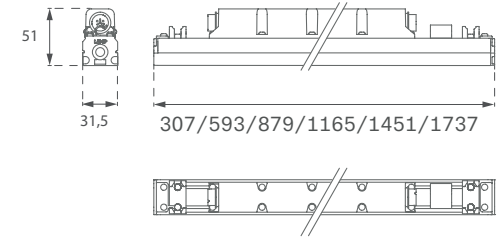

DUIT LIGHT ENGINE AMBIENT

Family	Installation	Format	Lm LED/m	Optic	CRI	K	Gear	Finishes	
DT1	SF Surface	300 300mm	A0 1000lm	WF Wide Flood	8 80	27 2700 K	0 0	B Black 06	
		600 600mm		WW Wall Washer		30 3000 K			
		900 900mm		GZ Grazer		40 4000 K			
		120 1200mm		OP Opal					
		150 1500mm		GZ Grazer		8 80			A Amber
		180 1800mm		WW Wall Washer					

DT1	SF	300	A0	WF	8	27	0	B
------------	-----------	------------	-----------	-----------	----------	-----------	----------	----------

DUIT LIGHT ENGINE

Family	Installation	Format	Lm LED/m	Optic	CRI	K	Gear	Finishes	
DT1	SF Surface	300 300mm	L0 2160lm	WF Wide Flood	8 80	27 2700 K	0 0	B Black 06	
		600 600mm		WW Wall Washer		30 3000 K			
		900 900mm		GZ Grazer		40 4000 K			
		120 1200mm		GZ Grazer		8 80			A Amber
		150 1500mm		WW Wall Washer					
		180 1800mm							

DT1	SF	300	L0	WF	8	27	0	B
------------	-----------	------------	-----------	-----------	----------	-----------	----------	----------





TECHNICAL CHARACTERISTICS

Light output and power

DUIT

				300mm		600mm		900mm		1200mm		1500mm		1800mm	
	K	CRI	W	lm Output	W	lm Output	W	lm Output	W	lm Output	W	lm Output	W	lm Output	
AO	WF	2700	80	1,3	102	2,6	204	3,9	306	5,2	408	6,5	510	7,8	612
		3000	80	1,3	105	2,6	209	3,9	314	5,2	418	6,5	523	7,8	627
		4000	80	1,3	111	2,6	221	3,9	332	5,2	442	6,5	553	7,8	663
		Amber	80	-	-	-	-	-	-	-	-	-	-	-	-
	WW	2700	80	1,3	96	2,6	193	3,9	289	5,2	386	6,5	482	7,8	578
		3000	80	1,3	100	2,6	199	3,9	299	5,2	398	6,5	498	7,8	597
		4000	80	1,3	105	2,6	210	3,9	315	5,2	420	6,5	525	7,8	630
		Amber	80	1,3	113	2,6	226	3,9	339	5,2	452	6,5	565	7,8	678
	OP	2700	80	1,3	95	2,6	191	3,9	286	5,2	382	6,5	477	7,8	573
		3000	80	1,3	97	2,6	195	3,9	292	5,2	390	6,5	487	7,8	585
		4000	80	1,3	103	2,6	206	3,9	309	5,2	412	6,5	515	7,8	619
		Amber	80	-	-	-	-	-	-	-	-	-	-	-	-
	GZ	2700	80	1,3	120	2,6	240	3,9	360	5,2	480	6,5	600	7,8	720
		3000	80	1,3	123	2,6	246	3,9	369	5,2	492	6,5	615	7,8	738
		4000	80	1,3	130	2,6	260	3,9	390	5,2	520	6,5	650	7,8	780
		Amber	80	1,3	139	2,6	278	3,9	417	5,2	556	6,5	695	7,8	834
LO	WF	2700	80	3,3	291	6,6	581	9,9	872	13,2	1163	16,5	1454	19,8	1744
		3000	80	3,3	299	6,6	598	9,9	898	13,2	1197	16,5	1496	19,8	1795
		4000	80	3,3	316	6,6	632	9,9	949	13,2	1265	16,5	1581	19,8	1897
		TW	-	-	-	-	-	-	-	-	-	-	-	-	-
	WW	2700	80	3,3	279	6,6	558	9,9	837	13,2	1115	16,5	1394	19,8	1673
		3000	80	3,3	287	6,6	574	9,9	860	13,2	1147	16,5	1434	19,8	1721
		4000	80	3,3	316	6,6	632	9,9	949	13,2	1265	16,5	1581	19,8	1897
		Amber	80	3,3	317	6,6	634	9,9	950	13,5	1267	16,5	1584	19,8	1901
	GZ	2700	80	3,3	342	6,6	684	9,9	1026	13,2	1368	16,5	1710	19,8	2052
		3000	80	3,3	353	6,6	704	9,9	1056	13,2	1408	16,5	1760	19,8	2112
		4000	80	3,3	372	6,6	744	9,9	1116	13,2	1488	16,5	1860	19,8	2232
		Amber	80	3,3	390	6,6	780	9,9	1170	13,2	1560	19,5	1950	19,8	2340



TECHNICAL CHARACTERISTICS

Optics

WF

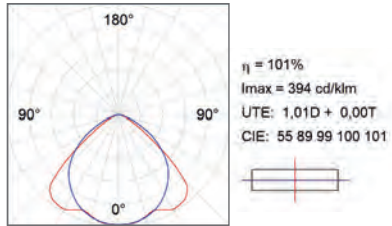

WW

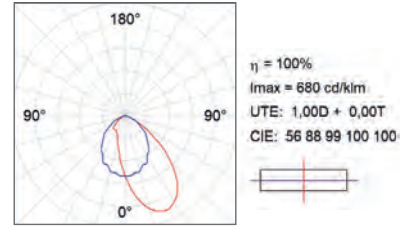

GZ

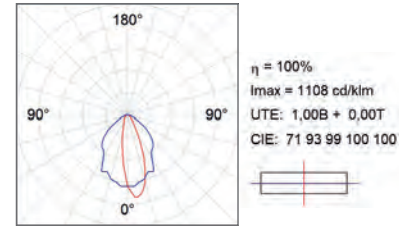

OP

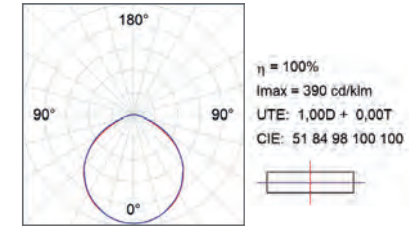

BASIC INSTALLATION ACCESSORIES

Surface basic profile



Ref.	Color
DTBASFPR600B	●
DTBASFPR900B	●
DTBASFPR1200B	●
DTBASFPR1500B	●
DTBASFPR1800B	●

Indirect basic profile



Ref.	Color
DTBAIDPR900B	●
DTBAIDPR1200B	●
DTBAIDPR1500B	●
DTBAIDPR1800B	●

Recessed basic profile



Ref.	Color
DTBAREB0300I	●
DTBAREB0600I	●
DTBAREB01200I	●
DTBAREB01500I	●
DTBAREB01800I	●
	●
	●
	●
	●
	●
	●
	●
	●
	●
	●
	●
	●
	●

Surface end cover



Ref.
DTBASFCB

Rigid suspension



Ref.
DTBASUG0100I

Height-adjustable steel cable



Ref.
Direct:
F3SUWIDE1000G
F3SUWIDE4000G
Indirect:
DTBAIDSUWIDE1000G
DTBAIDSUWIDE4000G

Intermediate joint



Ref.
DTBAJO

Wall bracket union 2 unit. / ref.



Ref.
DTBAFX45

Adjustable wall bracket 2 unit. / ref.



Ref.
DTBASUAJ50



INTEGRATION PROFILE ACCESSORIES

Trimless integration profile



Ref.	Color
DTBATRPR600B	●
DTBATRPR900B	●
DTBATRPR1200B	●
DTBATRPR1500B	●
DTBATRPR1800B	●

Asymmetric recessed integration profile

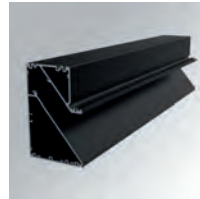

Ref.	Color
DTBAASPR300B	●
DTBAASPR600B	●
DTBAASPR900B	●
DTBAASPR1200B	●
DTBAASPR1500B	●
DTBAASPR1800B	●

Trimless end cover



Ref.
DTBATRCB

Recessed asymmetric end cover 2 unit. / ref.



Ref.
DTBAASRCB

Trimless intermediate joint



Ref.
DTBATRJO

Recessed asymmetric intermediate joint



Ref.
DTBAASJO



MINIMUM PROFILE ACCESSORIES

Corner anchor



Ref.
DTFCRI

Horizontal anchor



Ref.
DTFXVI

Lateral anchor



Ref.
DTFSII

OPTIC ACCESSORIES

Horizontal anti-glare louvre

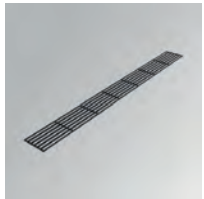

Ref.
DTLOH300BK
DTLOH600BK
DTLOH900BK
DTLOH1200BK
DTLOH1500BK
DTLOH1800BK

Vertical anti-glare louvre

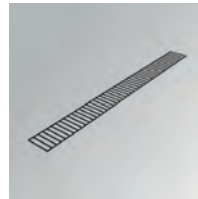

Ref.
DTLOV300BK
DTLOV600BK
DTLOV900BK
DTLOV1200BK
DTLOV1500BK
DTLOV1800BK

ACCESSORIES

Hose



Ref.
WI2X1NG

Tunable White:
WI3X1NG

Connector



Ref.
CT3P67N
CTY6P67N

INSTALLATION POSSIBILITIES

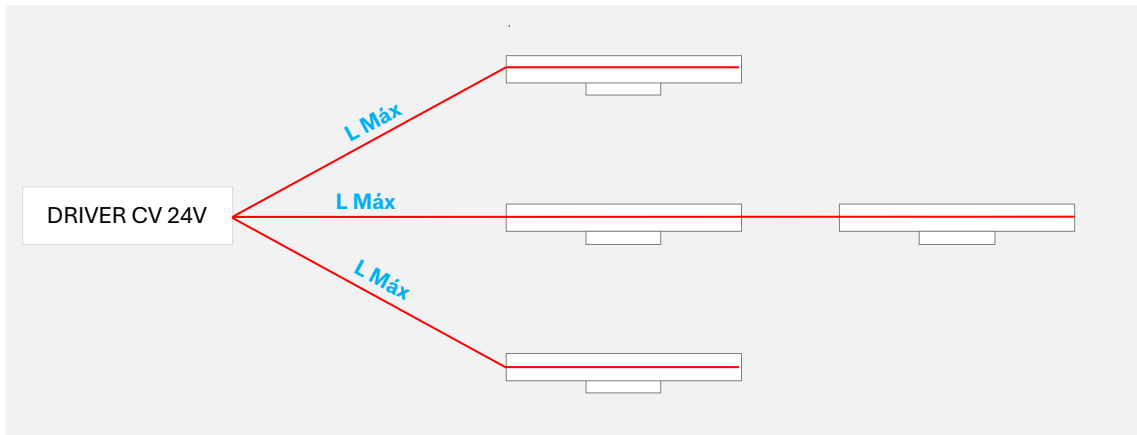
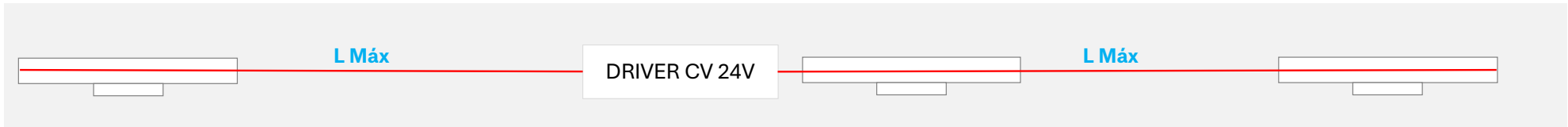
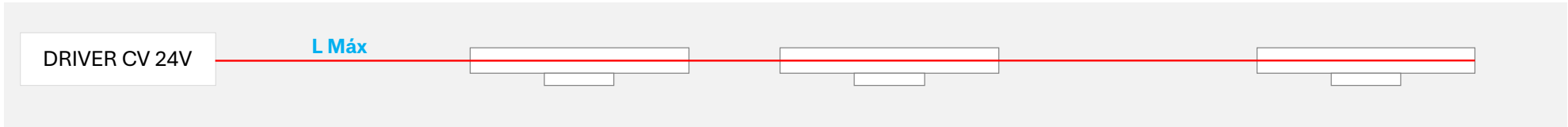

L Máx ≤ Maximum distance between driver and last luminaire.

MAXIMUM ALLOWED DISTANCE		
	MAXIMUM CONSUMPTION (W)	MAXIMUM LENGTH (M)
ON/OFF	DRV673024N	28 W
	DRV677524N	71 W
	DRV6710024N	95 W
DALI	DRV676024D	57 W
	DRV679024D	85 W
	DRV6712024D	114 W
		5 M

- Always choose the most restrictive value for the choice of power supply equipment per line of luminaires, either maximum consumption, or maximum distance between driver and last luminaire.



DRIVERS ON/OFF CV 24V

Power Supply ON/OFF



Ref.
DRV673024N

Power Supply ON/OFF



Ref.
DRV677524N

Power Supply ON/OFF



Ref.
DRV6710024N

DRIVERS DALI

Power Supply DALI



Ref.
DRV679024D

Power Supply DALI



Ref.
DRV6712024D

Power Supply DALI



Ref.
DRV676024D



Flut



Flut 180
Symmetric

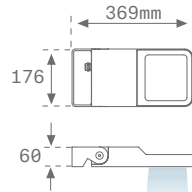

Flut 180
Asymmetric

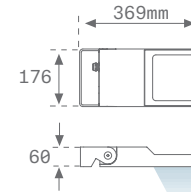

Flut 180
Street

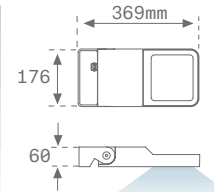

FLUT 180

Family	Lm LED	Optic	CRI	K	Gear	Finishes
MF2	35 3500lm	AS Asymmetric	8 80	30 3000 K	N ON/OFF	G Grey 03
	65 6500lm	SY Symmetric		40 4000 K		A Anthracite 01
		ST Street				
MF2	35	AS	8	30	N	G

TECHNICAL CHARACTERISTICS

Optics

SYMMETRIC

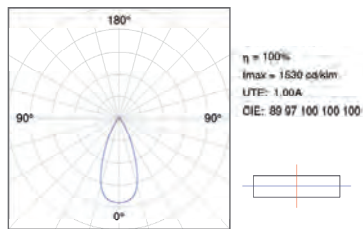

ASYMMETRIC

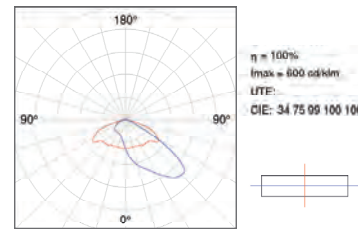

STREET

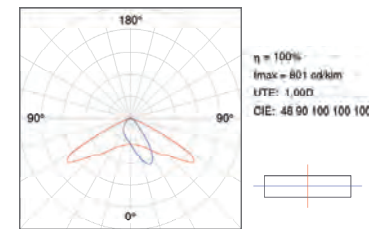

Light output and power

FLUT 180

	K	CRI	3500lm		6500lm	
			W	lm Output	W	lm Output
SY	3000	80	25,7	2937	49,1	4768
	4000	80	25,7	3092	49,1	5019
AS	3000	80	25,7	2460	49,1	4491
	4000	80	25,7	2589	49,1	4728
ST	3000	80	25,7	2672	49,1	4741
	4000	80	25,7	2813	49,1	4991

STREET





ACCESSORIES

Anti-glare louvres Street



Ref.	Color
MFLOSTB	● Street

Anti-glare louvres Asymmetric



Ref.	Color
MFLOASB	● Asymmetric

Shot/Flut/Mini Flut aluminium clamps for ø120-130 mm pole



	Ref.	Color
1 lum.	COARIN120G COARIN120A	● ●
2 lum.	COARDB120G COARDB120A	● ●

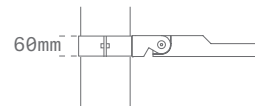

Shot/Flut/Mini Flut aluminium fixing bracket for ø60-135 mm pole



	Ref.	Color
1 lum.	COARIN060G COARIN060A	● ●

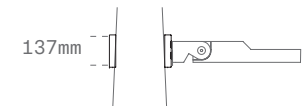



Flut 280
Symmetric

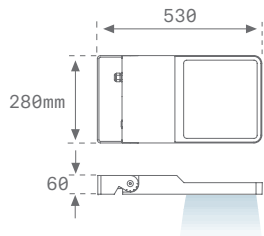

Flut 280
Asymmetric

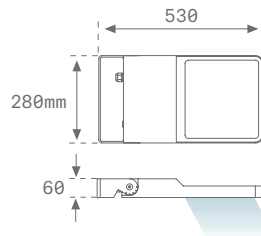

Flut 280
Street

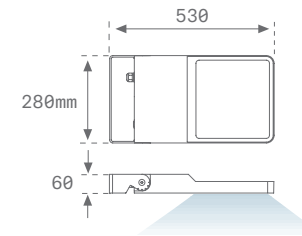

FLUT 280

Family	Lm LED	Optic	CRI	K	Gear	Finishes
FL2	09 9300lm	AS Asymmetric	8 80	30 3000 K	N ON/OFF	G Grey 03
	14 14000lm	SY Symmetric		40 4000 K		A Anthracite 01
	19 18700lm	ST Street				
FL2	09	AS	8	30	N	G

STREET





TECHNICAL CHARACTERISTICS

Optics

SYMMETRIC

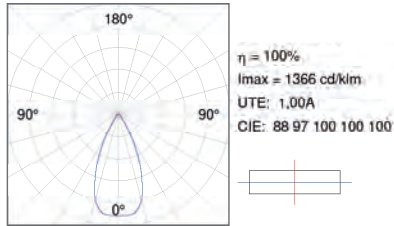

ASYMMETRIC

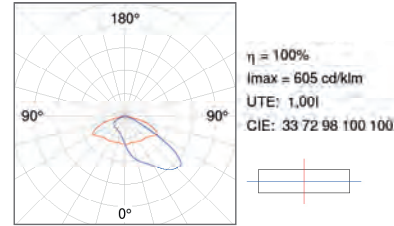

STREET

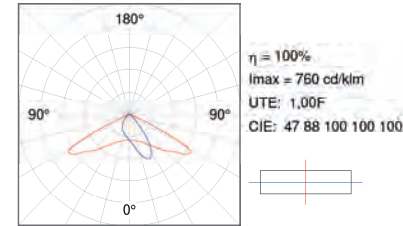

Light output and power

FLUT 280

	K	CRI	9300lm		14000lm		18700lm	
			W	lm Output	W	lm Output	W	lm Output
SY	3000	80	64,9	8161	97,7	11833	125,6	15430
	4000	80	64,9	8591	97,7	12455	125,6	16242
AS	3000	80	64,9	7687	97,7	11608	125,6	15256
	4000	80	64,9	8092	97,7	12219	125,6	16060
ST	3000	80	64,9	8117	97,7	12039	125,6	16058
	4000	80	64,9	8543	97,7	12673	125,6	16903



ACCESSORIES

Anti-glare louvres Street



Ref.
FLL0STB

Color
● Street

Anti-glare louvres Asymmetric



Ref.
FLL0AS1B
FLL0AS1B

Color
● Asymmetric 32/64 LED
● Asymmetric 18 LED

Shot/Flut/Mini Flut aluminium clamps for ø120-130 mm pole



Ref.
COARIN120G
COARIN120A

Color
●
●

1 lum.
2 lum.

Ref.
COARDB120G
COARDB120A

Color
●
●

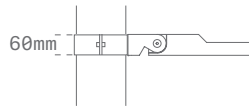

Shot/Flut/Mini Flut aluminium fixing bracket for ø60-135 mm pole



Ref.
COARIN060G
COARIN060A

Color
●
●

1 lum.

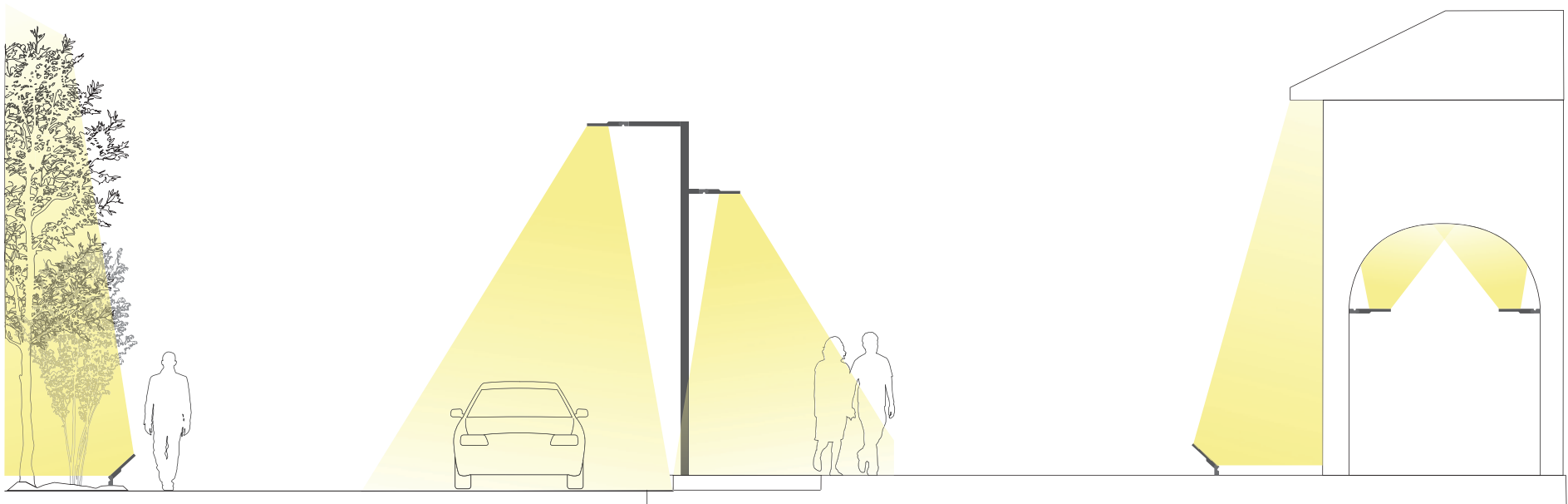
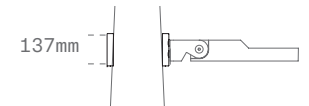



Gap



Gap

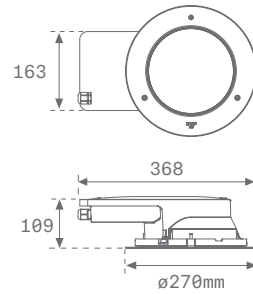

GAP

Family	Lm LED	Optic	CRI	K	Gear	Finishes
GA2	15 1400lm	SP SP 11°	8 80	30 3000 K	N ON/OFF	I Inox 02
	30 2800lm	MF MFL 23°				
	35 3600lm	WF WFL 46°				
GA2	15	SP	8	30	N	I





TECHNICAL CHARACTERISTICS

Optics

SP 11°

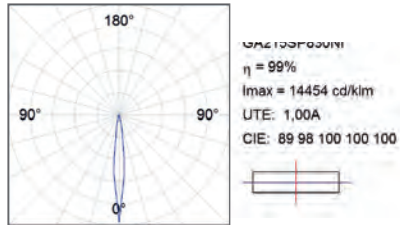

MFL 23°

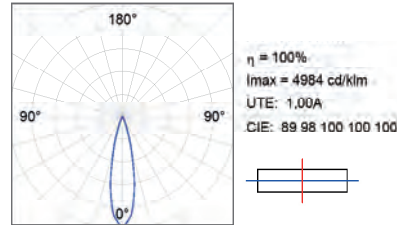

WFL 46°

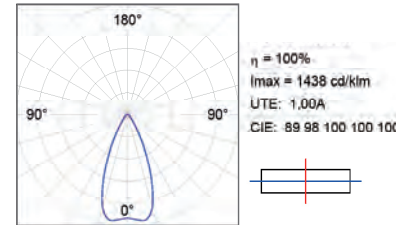

Light output and power

GAP

	K	CRI	1400lm		2800lm		3600lm	
			W	lm Output	W	lm Output	W	lm Output
SP 11°	3000	80	13	1130	23	2171	33,5	2944
	4000	80	13	1130	23	2171	33,5	2944
MFL 23°	3000	80	13	1081	23	2113	33,5	2851
	4000	80	13	1081	23	2113	33,5	2851
WFL 46°	3000	80	13	1092	23	2124	33,5	2877
	4000	80	13	1092	23	2124	33,5	2877

ACCESSORIES

Recessed ceiling ring and decorative frame



Ref.
GARERIRDM

Pict.



Concrete recessing box



Ref.
GAREBOB

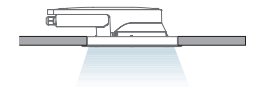
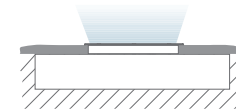
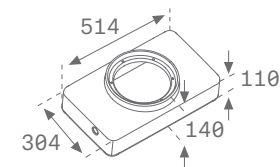



Lup



Lup Ø70
1300lm

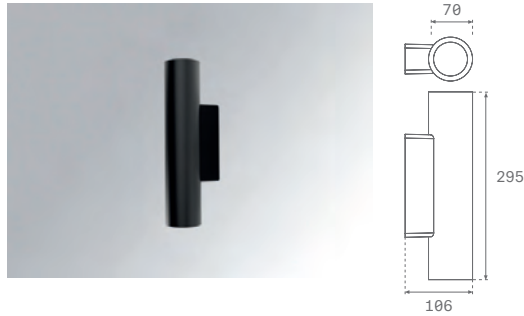

Lup Ø110
3000lm

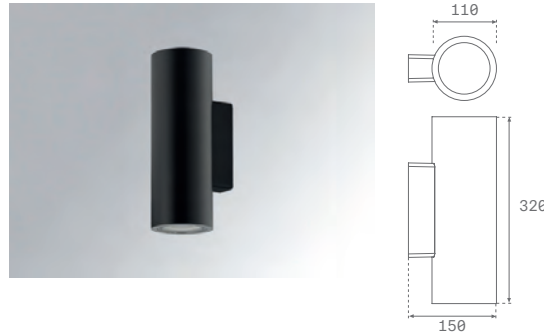

LUP DIRECT

Family	Diameter	Optic	Lm LED	Optic	K	Gear	Finishes
LW1	70 ø70mm	DR Direct	10 1300lm	AS Asymmetric	30 3000 K 40 4000 K	N ON/OFF	B Black 03
	110 ø100mm	DR Direct	30 3000lm	AS Asymmetric	40 4000 K	N ON/OFF	B Black 03
LW1	70	DR	10	AS	30	N	B

LUP DIRECT-INDIRECT

Family	Diameter	Optic	Lm LED	Optic	K	Gear	Finishes
LW1	70 ø70mm	DI Direct-Indirect	10 650+650lm	SP SP 10° MF MFL 38° WF WFL 60°	30 3000 K 40 4000 K	N ON/OFF	B Black 03
	110 ø100mm	DI Direct-Indirect	40 2000+2000lm	SP SP 16° FL FL 32° WF WFL 53°	40 4000 K	N ON/OFF	B Black 03
LW1	70	DI	10	SP	30	N	B





TECHNICAL CHARACTERISTICS

Optics

AS

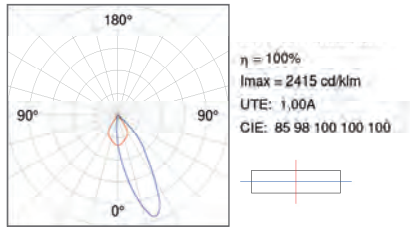

SP 10°-16°

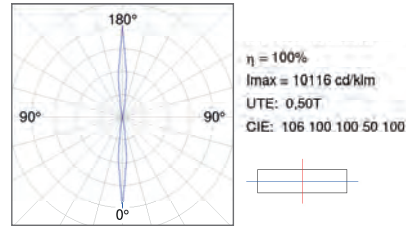

MFL 38°

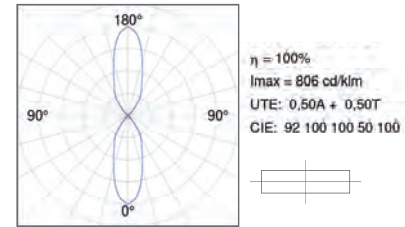

WFL 53°-60°

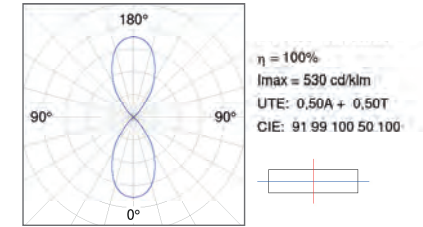

Light output and power

LUP Ø70

		1300lm			
		K	CRI	W	lm Output
DIR	ASYM	3000	80	10,6	665
		4000	80	10,6	705
		650+650lm			
		K	CRI	W	lm Output
DIR-IND	SP	3000	80	12,4	863
	10°	4000	80	12,4	928
	MFL	3000	80	10,1	1011
	38°	4000	80	10,1	1072
	WFL	3000	80	10,1	1031
	60°	4000	80	10,1	1093

LUP Ø110

		3000lm			
		K	CRI	W	lm Output
DIR	ASYM	4000	80	25,8	1295
		2000+2000lm			
		K	CRI	W	lm Output
DIR-IND	SP	4000	80	37,2	2510
	16°				
	MFL	4000	80	30,8	2706
	32°				
	WFL	4000	80	30,8	2748
	53°				



Lup Downlight Ø110



Lup Downlight Ø162

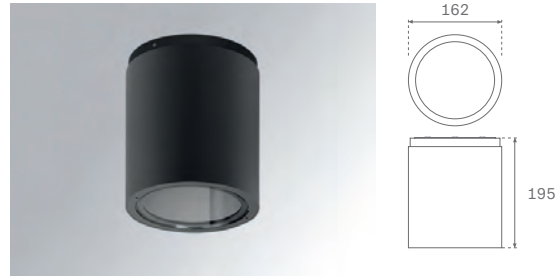

LUP DOWNLIGHT

Family	Diameter	Lm LED	Optic	K	Gear	Finishes
LS1	110 ø110mm	05 900lm	FL FL 34°	30 3000 K	N ON/OFF	B Black 03
		10 1300lm	WF WFL 54°	40 4000 K		
	162 ø162mm	30 3000lm	FL FL 30°	40 4000 K	N ON/OFF	B Black 03
		40 4000lm	WF WFL 71°			
LS1	110	05	FL	30	N	B

TECHNICAL CHARACTERISTICS

Light output and power

LUP Ø110

	K	CRI	900lm		1300lm	
			W	lm Output	W	lm Output
FL 34°	3000	80	6,3	600	9,7	963
	4000	80	6,3	626	9,7	1003
WFL 54°	3000	80	6,3	624	9,7	1008
	4000	80	6,3	650	9,7	1080

LUP Ø162

	K	CRI	3000lm		4000lm	
			W	lm Output	W	lm Output
FL 30°	4000	80	25,9	2162	33,9	2850
	4000	80	25,9	2392	33,9	3114





Mun Dark IP65

Mun Dark IP65
140

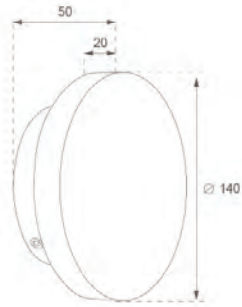

Mun Dark IP65
200

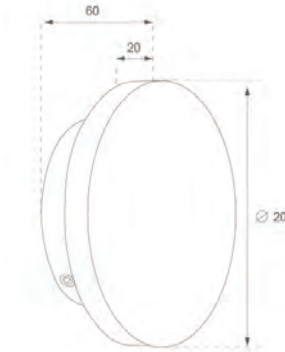

MUN DARK IP65		Class	Optic		CRI		Gear		Finishes	
Familia	Instalación	Formato	Lm	LED	IP	IRC	K	Equipo	Acabados	
MD1	SF Surface	140 140mm 200 200mm	01	100lm	65 IP65	8 80	30 3000 K	N ON/OF	B Black 05 W White	
MD1	SF	140	01		65	8	30	N	B	

CARACTERÍSTICAS TÉCNICAS

MUN DARK IP65

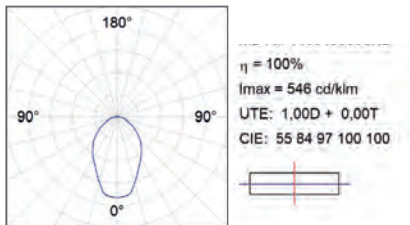

MUN DARK IP65

	K	CRI	W	140lm		200lm	
				W	lm Output	W	lm Output
WH	3000	80	6,8	440	9,1	630	
BK				370		540	



Niu

Niu Symmetric

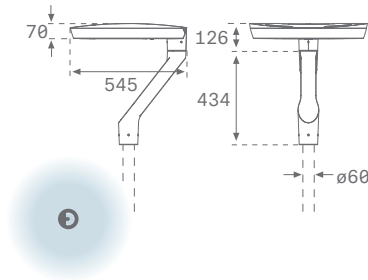

Niu Street

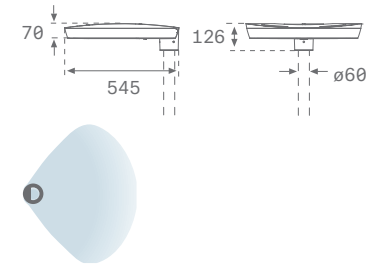

NIU

Family	Lm LED	Class	Optic	CRI	K	Gear	Finishes
NI1	45 4500lm	1 I	SY Symmetric	7 70	40 4000 K	N ON/OF	G Grey 03
	90 9000lm	2 II	ST Street				
NI1	45	1	SY	7	40	N	G

TECHNICAL CHARACTERISTICS

Optics

SY

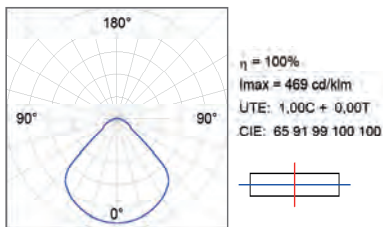

ST

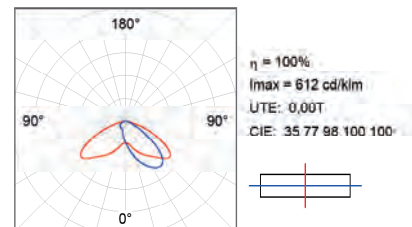

Light output and power

NIU

	K	CRI	4500lm		9000lm	
			W	lm Output	W	lm Output
SY	4000	70	52	4068	104	8013
ST	4000	70	52	3439	104	6737

STREET



Final arm ø60mm



Ref.
NIARED60G

Wall arm



Ref.
NIAR650G

Pole clamp 60-135mm



Ref.
NIPOBR135G

Pole adapter ø76mm



Ref.
NIPOAD76G

Semicurved pole bracket



Ref.
NIPOBR48G ø48mm
NIPOBR60G ø60mm



Owl

Owl
Street

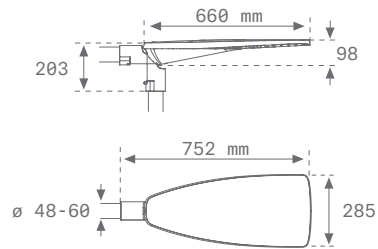

OWL

Family	Lm LED	Class	Optic	CRI	K	Gear	Finishes
OW1	05 4800lm	1 I	ST Street	8 80	40 4000 K 30 3000 K	N ON/OF	G Grey 03
	09 8500lm	1 I 2 II					
	13 12500lm	1 I 2 II					
	18 17500lm	1 I 2 II					
OW1	05	1	ST	8	40	N	G



TECHNICAL CHARACTERISTICS

Optics

ST

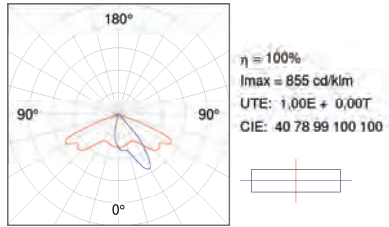

Light output and power

OWL

	K	CRI	4800lm		8500lm		12500lm		17500lm	
			W	lm Output	W	lm Output	W	lm Output	W	lm Output
ST	3000	80	37,6	3871	68	7789	103	11228	135	14762
	4000	80	37,6	3871	68	7789	103	11228	135	14762

ACCESSORIES

OWL wall arm

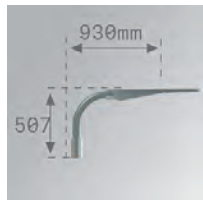

Ref.
OWAR1000G

Other optics possibility



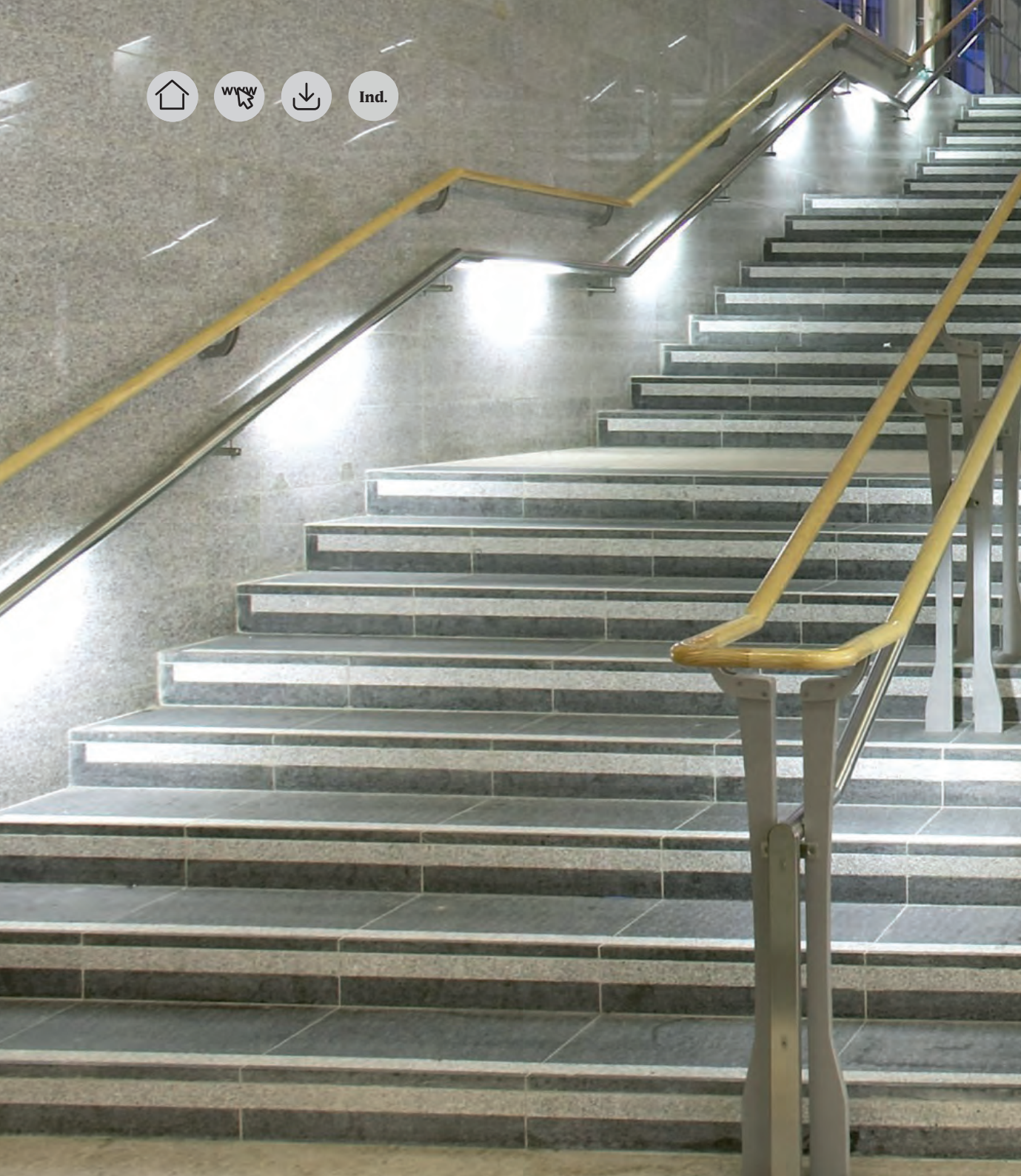

Puck

Puck

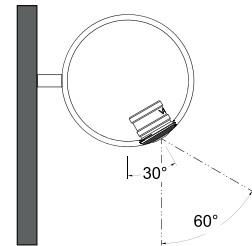
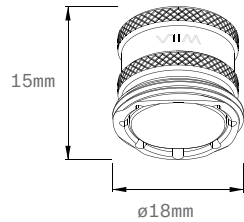

Symmetric Distribution (ONE SIDED)



MP1201501

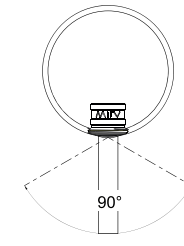

Double Symmetric Distribution (DBL SIDED)



MP1201503

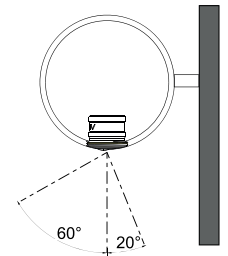

Asymmetric Distribution (ASYM)



MP1201505

Ref.	Description
MP1201501-70-30	PUCK XT 3000K ONE SIDED 1.5W
MP1201501-70-40	PUCK XT 4000K ONE SIDED 1.5W
MP1201503-70-30	PUCK XT 3000K DBL SIDED 1.5W
MP1201503-70-40	PUCK XT 4000K DBL SIDED 1.5W
MP1201505-70-30	PUCK XT ASYM 3000K 1.5W
MP1201505-70-40	PUCK XT ASYM 4000K 1.5W

ACCESSORIES

Ref.	Description
MP-002	Puck crimp pliers/tool
MP-003	Gel connectors (2 required per puck)
MP-004	Loctite 243 10ml bottle
MP-011	Puck xt insertion tool



MP-011

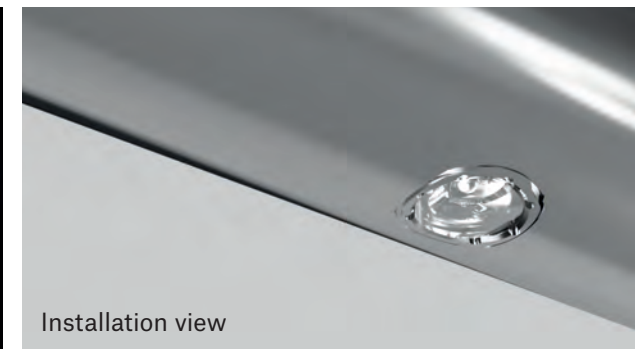

Installation view





TECHNICAL CHARACTERISTICS

Optics

Symmetric-Double Symmetric

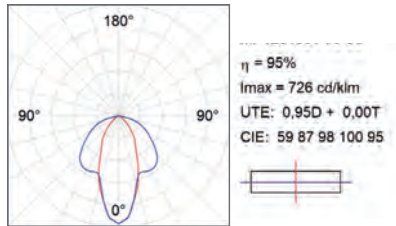

Asymmetric

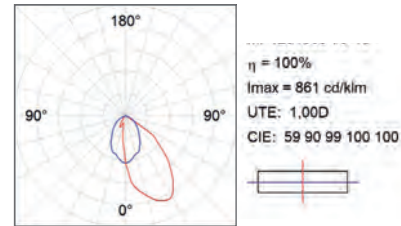

Light output and power

	K	CRI	W	lm Output
One-sided Beam	3000	80	1,5	169
	4000	80	1,5	177
Double-sided Beam	3000	80	1,5	170
	4000	80	1,5	185
Asymmetric	3000	80	1,5	159
	4000	80	1,5	169



Seti

Seti
Soft 500

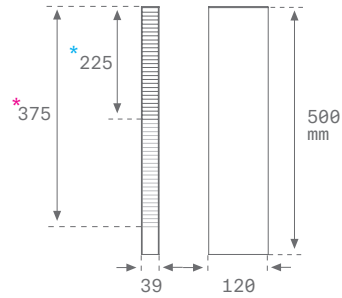

SETI SOFT 500

Family	Dimension	Format	Lm LED	Optic	CRI	K	Gear	Finishes Ext.	Finishes
SE1	050 500mm	I Individual*	02 200lm	S0 Soft	8 80	30 3000 K	N ON/OFF	B Black 03	W White
		D Double*	03 300lm					A Anthracite 01	B Black
SE1	050	I	02	S0	8	30	N	B	W

TECHNICAL CHARACTERISTICS

Optics

SOFT 500 INDIVIDUAL

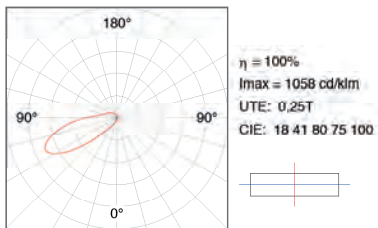

SOFT 500 DOUBLE

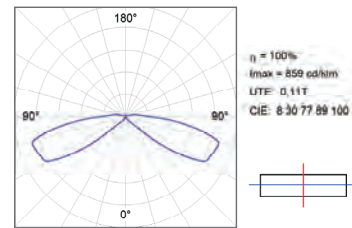

Light output and power

SOFT 500

		200lm			
Format	Color	K	CRI	W	lm Output
IN	B/W	3000	80	3,4	41
	A/B	3000	80	3,4	20
		300lm			
Format	Color	K	CRI	W	lm Output
DB	B/W	3000	80	3,9	49
	A/B	3000	80	3,9	28



Seti
Soft 900

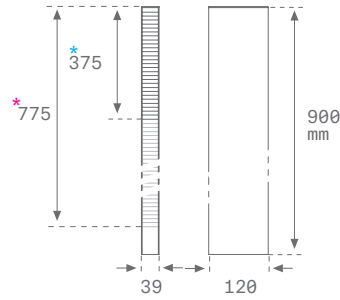

SETI SOFT 900

Family	Dimension	Format	Lm LED	Optic	CRI	K	Gear	Finishes Ext.	Finishes
SE1	090 900mm	I Individual*	05 500lm	S0 Soft	8 80	30 3000 K	N ON/OFF	B Black 03	W White
		D Double*						A Anthracite 01	B Black
SE1	090	I	05	S0	8	30	N	B	W

TECHNICAL CHARACTERISTICS

Optics

SOFT 900 INDIVIDUAL

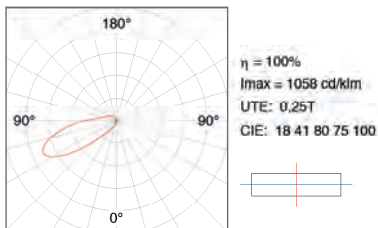

SOFT 900 DOUBLE

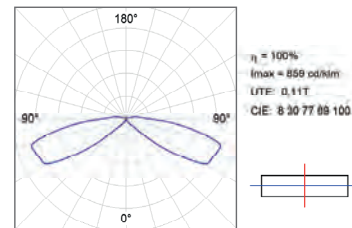

Light output and power

SOFT 900

Format	Color	K	CRI	500lm	
				W	lm Output
IN	B/W	3000	80	6,8	87
	A/B	3000	80	6,8	43
DB	B/W	3000	80	6,4	86
	A/B	3000	80	6,4	49



Seti
Soft 1200

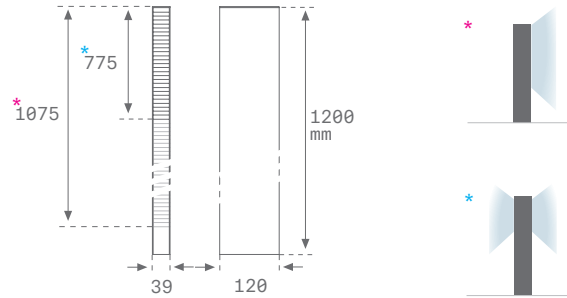

SETI SOFT 1200

Family	Dimension	Format	Lm LED	Optic	CRI	K	Gear	Finishes Ext.	Finishes
SE1	120 1200mm	I Individual*	07 700lm	S0 Soft	8 80	30 3000 K	N ON/OFF	B Black 03	W White
		D Double*	10 1000lm	A Anthracite 01				B Black	
SE1	120	I	07	S0	8	30	N	B	W

TECHNICAL CHARACTERISTICS

Optics

SOFT 1200 INDIVIDUAL

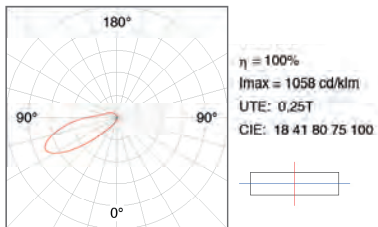

SOFT 1200 DOUBLE

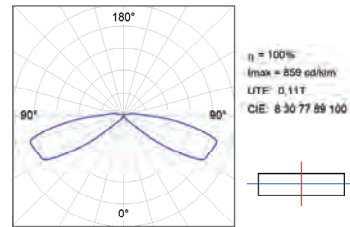

Light output and power

SOFT 1200

		700lm			
Format	Color	K	CRI	W	lm Output
IN	B/W	3000	80	9,4	116
	A/B	3000	80	9,4	92
		1000lm			
Format	Color	K	CRI	W	lm Output
DB	B/W	3000	80	13	185
	A/B	3000	80	13	106



Seti
Spot 500

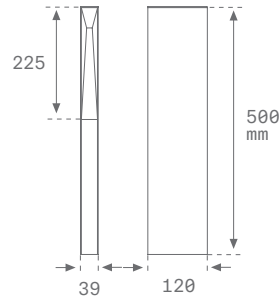

SETI SPOT 500

Family	Dimension	Format	Lm LED	Optic	CRI	K	Gear	Finishes Ext.	Finishes
SE1	050 500mm	I Individual*	02 200lm	SP Spot	8 80	30 3000 K	N ON/OFF	B Black 03	W White
		D Double*	03 300lm	A Anthracite 01				B Black	
SE1	050	I	02	SP	8	30	N	B	W

TECHNICAL CHARACTERISTICS

Optics

SPOT 500 INDIVIDUAL

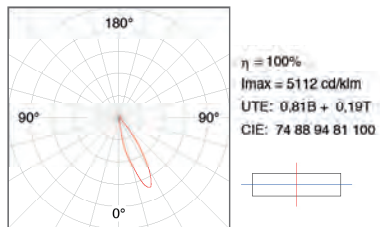

SPOT 500 DOUBLE

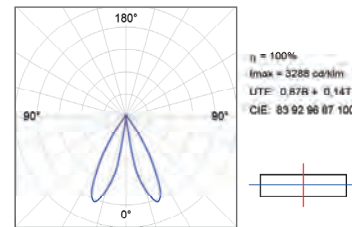

Light output and power

SPOT 500

Format	Color	K	CRI	200lm	
				W	lm Output
IN	B/W	3000	80	4,7	107
	A/B	3000	80	4,7	80
				300lm	
DB	Color	K	CRI	W	lm Output
				B/W	3000
	A/B	3000	80	9,2	195



Seti
Spot 900

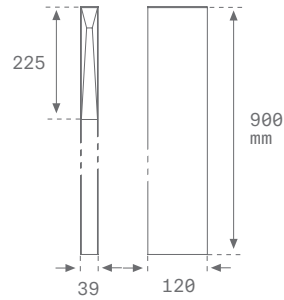

SETI SPOT 900

Family	Dimension	Format	Lm LED	Optic	CRI	K	Gear	Finishes Ext.	Finishes
SE1	090 900mm	I Individual*	05 500lm	SP Spot	8 80	30 3000 K	N ON/OFF	B Black 03	W White
		D Double*	05 500lm					A Anthracite 01	B Black
SE1	090	I	05	SP	8	30	N	B	W

TECHNICAL CHARACTERISTICS

Optics

SPOT 900 INDIVIDUAL

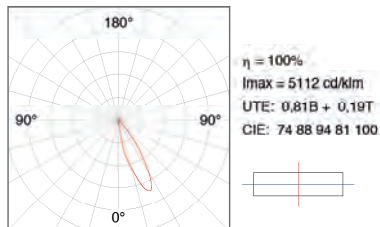

SPOT 900 DOUBLE

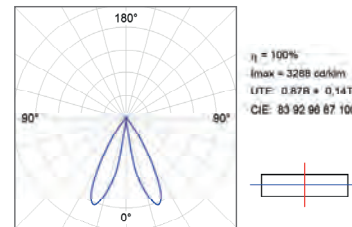

Light output and power

SPOT 900

				200lm	
Format	Color	K	CRI	W	lm Output
IN	B/W	3000	80	4,7	130
	A/B	3000	80	4,7	97
				300lm	
Format	Color	K	CRI	W	lm Output
DB	B/W	3000	80	9,2	261
	A/B	3000	80	9,2	195



Seti
Spot 1200

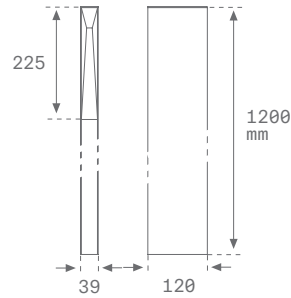

SETI SPOT 1200

Family	Dimension	Format	Lm LED	Optic	CRI	K	Gear	Finishes Ext.	Finishes
SE1	120 1200mm	I Individual*	07 700lm	SP Spot	8 80	30 3000 K	N ON/OFF	B Black	W White
		D Double*	10 1000lm					A Anthracite	B Black
SE1	120	I	07	SP	8	30	N	B	W

TECHNICAL CHARACTERISTICS

Optics

SPOT 1200 INDIVIDUAL

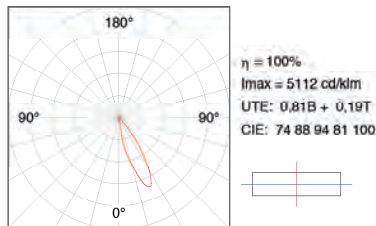

SPOT 1200 DOUBLE

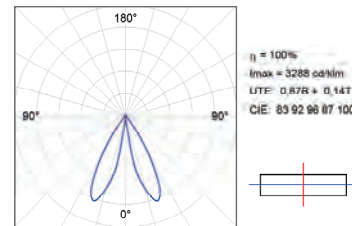

Light output and power

SPOT 1200

Format	Color	K	CRI	200lm	
				W	lm Output
IN	B/W	3000	80	4,7	130
	A/B	3000	80	4,7	97
Format	Color	K	CRI	300lm	
				W	lm Output
DB	B/W	3000	80	9,2	261
	A/B	3000	80	9,2	195





Shot



Shot 80 ON/OFF

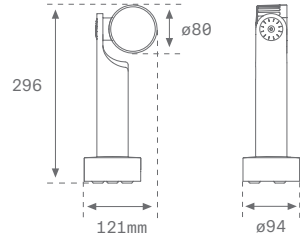

Shot 80 NO GEAR

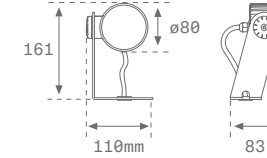
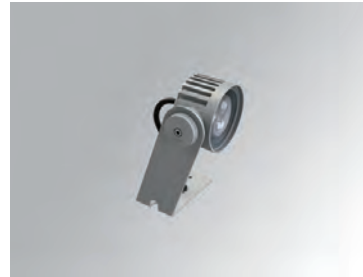

Ref: DRV6721700N

SHOT 80

Family	Lm LED	Optic	CRI	K	Gear	Finishes
MC2	09 900lm	SP SP 19° MF MFL 28°	8 80	30 3000 K 40 4000 K	N ON/OFF O NO GEAR	G Grey 03 A Anthracite 01
MC2	09	SP	8	30	N	G

TECHNICAL CHARACTERISTICS

Optics

SP 19°

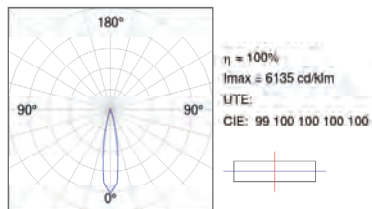

MF 28°

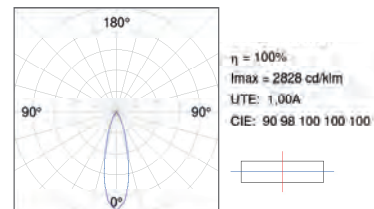

Light output and power

SHOT 80

	K	CRI	900lm	
			W	lm Output
SP	3000	80	9,4	720
19°	4000	80	9,4	720
MFL	3000	80	9,4	609
28°	4000	80	9,4	609





ACCESSORIES

Anti-glare screen



Ref.

MCSC82B

Color



Spike

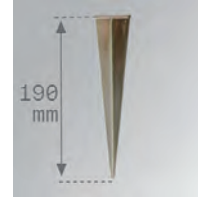

Ref.

MCSPM ●

Color



- Bichromatized anticorrosive treatment

Shot 120

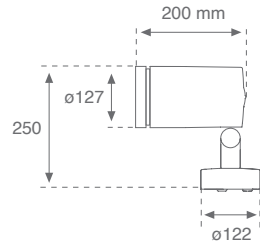

Shot 120 Bracket

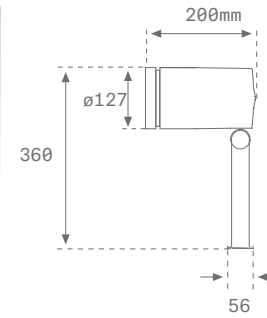

Shot 120 Pole

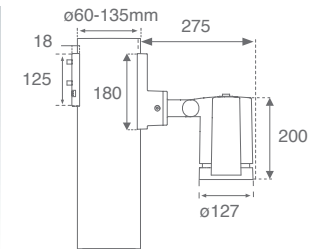

SHOT 120

Family	Lm LED	Optic	CRI	K	Gear	Finishes
MN2	15 1500lm	SP SP 11°	8 80	30 3000 K	N ON/OFF	G Grey 03
	30 2900lm	MF MFL 24°				A Anthracite 01
	40 3800lm					
MN2	15	SP	8	30	N	G

SHOT 120 BRACKET

Family	Installation	Lm LED	Optic	CRI	K	Gear	Finishes
MN2	BR Bracket	15 1500lm	SP SP 11°	8 80	30 3000 K	N ON/OFF	G Grey 03
		30 2900lm	MF MFL 24°				A Anthracite 01
		40 3800lm					
MN2	BR	15	SP	8	30	N	G

SHOT 120 POLE

Family	Installation	Lm LED	Optic	CRI	K	Gear	Finishes
MN2	BJ Pole	15 1500lm	SP SP 11°	8 80	30 3000 K	N ON/OFF	G Grey 03
		30 2900lm	MF MFL 24°				A Anthracite 01
		40 3800lm					
MN2	BJ	15	SP	8	30	N	G





TECHNICAL CHARACTERISTICS

Optics

SP 11°

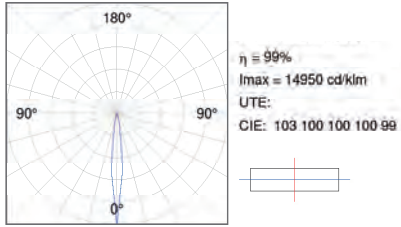

MFL 24°

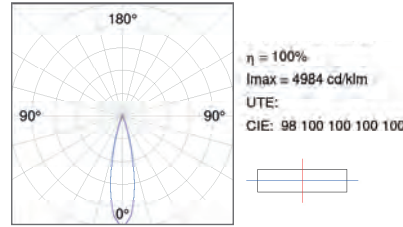

Light output and power

SHOT 120

	K	CRI	1500lm		2900lm		3800lm	
			W	lm Output	W	lm Output	W	lm Output
SP	3000	80	13,2	1146	23	2215	33,5	3032
11°	4000	80	13,2	1146	23	2215	33,5	3032
MFL	3000	80	13,2	1097	23	2155	33,5	2937
24°	4000	80	13,2	1097	23	2155	33,5	2937



ACCESSORIES

Aluminium pole (60x60 mm)

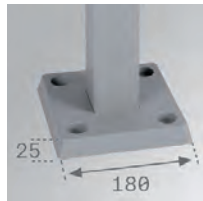

Lm	Ref.	Color	Fig.	Minishot	Pict.
1	MSP01000G	●	1/2	1 o 2	
1	MSP01000A	●	1/2	1 o 2	
2,5	MSP02500G	●	3/4	1 o 2	
2,5	MSP02500A	●	3/4	1 o 2	

Fixation pattern for anchoring pole

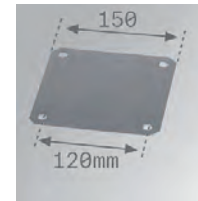

Ref.	Color
MSFTSQG	●

M8 concrete anchorage



Ref.	Color
MSFIC	●

1m wall bracket

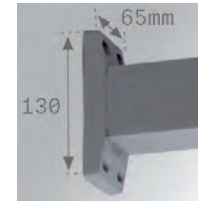

Ref.	Color	Fig.
MSAR1000G	●	5
MSAR1000A	●	5

● Bichromatized anticorrosive treatment

Spike

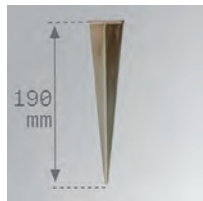

Ref.	Color	Fig.
MSSPM ●	●	6

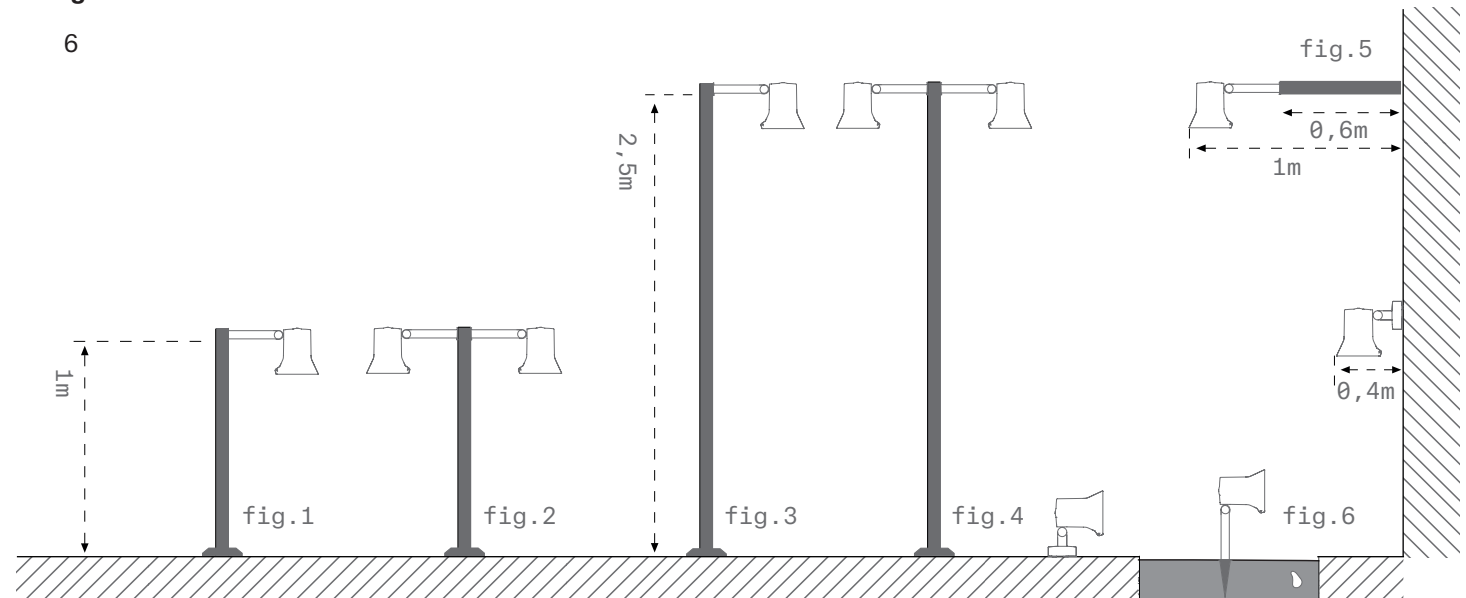

Shot 180
SP/MFL



Shot 180
Street

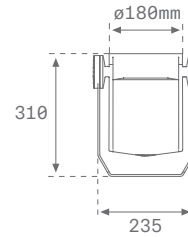

SHOT 180

Family	Lm LED	Optic	CRI	K	Gear	Finishes
SH2	50 5000lm	SP SP 11°	8 80	30 3000 K	N ON/OFF	G Grey 03 A Anthracite 01
	70 7200lm	MF MFL 23°-24°				
	50 5000lm	ST STREET	8 80	40 4000 K	N ON/OFF	G Grey 03 A Anthracite 01
	70 7200lm					
SH2	50	SP	8	30	N	G

TECHNICAL CHARACTERISTICS

Optics

SP 11°

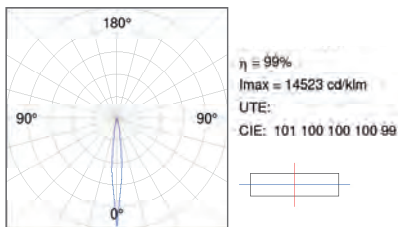

MFL 23°-24°

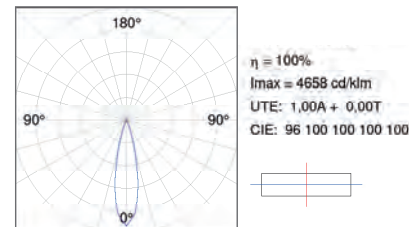

STREET

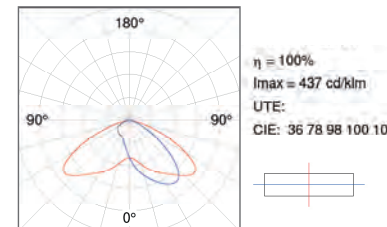

Light output and power

SHOT 180

	K	CRI	5000lm		7200lm	
			W	lm Output	W	lm Output
SP 11°	3000	80	41	4127	61,2	5419
	4000	80	41	4127	61,2	5419
MFL 24°	3000	80	41	4112	61,2	5396
	4000	80	41	4112	61,2	5396
ST	4000	80	41	3850	61,2	5050





ACCESSORIES

Anti-glare screen



Ref.	Color
SHSC184B	●

Shot LED System

SHOT / FLUT aluminium clamp for ø120-130 mm pole



	Ref.	Color
1 spot	COARIN120G	●
1 spot	COARIN120A	●
2 spot	COARDB120G	●
2 spot	COARDB120A	●

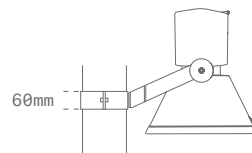

SHOT /FLUT aluminium fixing bracket for ø60-135 mm pole



	Ref.	Color
1 spot	COARIN060G	●
1 spot	COARIN060A	●

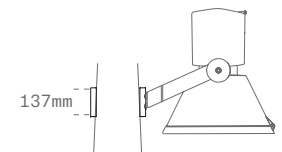



Shot 290

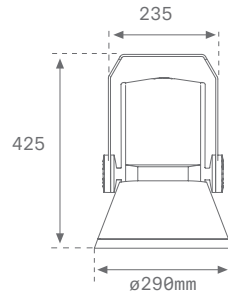

Shot 380

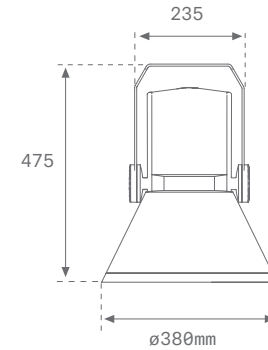

SHOT 290

Family	Format	Lm LED	Optic	CRI	K	Gear	Finishes
SH3	29 ø290	06 5500lm	SP SP	8 80	30 3000K	N ON/OFF	G Grey 03
		08 8000lm	MFL MFL VW VWF ST STREET				A Anthracite 01
SH3	29	06	SP	8	30	N	G

SHOT 380

Family	Format	Lm LED	Optic	CRI	K	Gear	Finishes
SH3	38 ø380	07 7000lm	SP SP	8 80	30 3000K	N ON/OFF	G Grey 03
		08 8000lm 10 10000lm	MFL MFL VW VWF ST STREET				A Anthracite 01
SH3	38	07	SP	8	30	N	G

STREET





TECHNICAL CHARACTERISTICS

Optics

SP

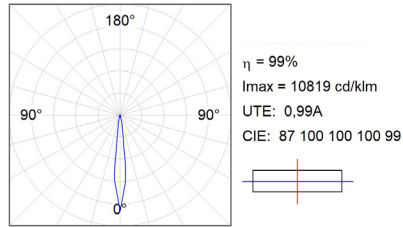

MFL

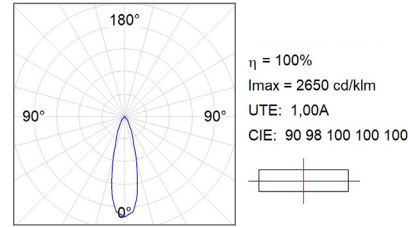

VWFL

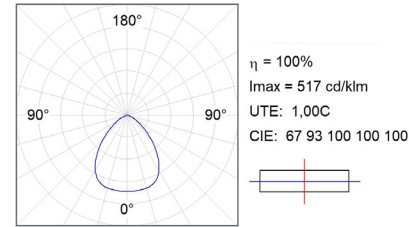

ST

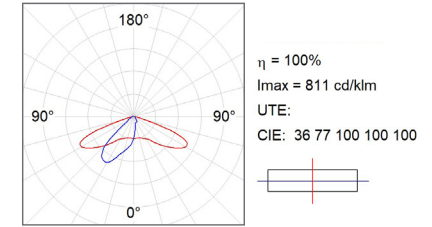

Light output and power

SHOT 290

	K	CRI	5500lm	
			W	lm Output
SP	3000	80	48	4220
	4000	80	48	4541
MFL	3000	80	48	4757
	4000	80	48	5063
VWFL	3000	80	48	4868
	4000	80	48	5181
ST	3000	80	48	4349
	4000	80	48	4629

SHOT 380

	K	CRI	7000lm		10000lm	
			W	lm Output	W	lm Output
SP	3000	80	51,1	5148	82,5	7257
	4000	80	51,1	5539	82,5	7809
MFL	3000	80	51,1	5703	82,5	8213
	4000	80	51,1	6071	82,5	8743
VWFL	3000	80	51,1	5836	82,5	8405
	4000	80	51,1	6213	82,5	8947
ST	3000	80	51,1	5214	82,5	7509
	4000	80	51,1	5550	82,5	7993

ACCESSORIES

290 circular anti-glare

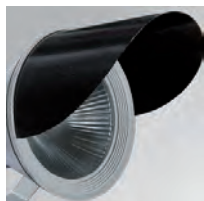

Ref. Color

SH29SC297B ●

● Non-compatible with road models

380 circular anti-glare

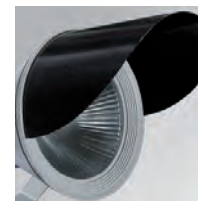

Ref. Color

SH38SC381B ●

● Non-compatible with road models



Ind.



Trace IP65



Trace IP65
100 Symmetric

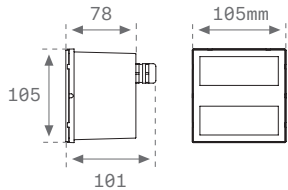

Trace IP65
200 Asymmetric

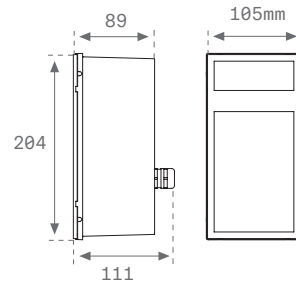

Trace IP65
200 Asymmetric

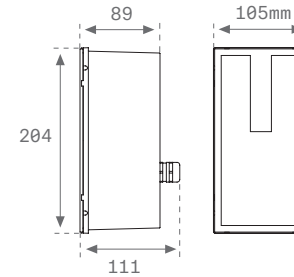

Trace IP65
200 Symmetric

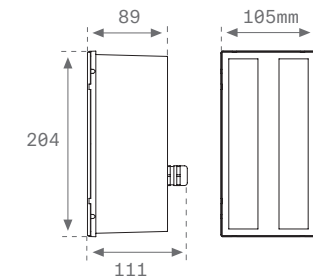

TRACE IP65 100 SY

Family	Dimension	Format	Lm LED	IP	Optic	CRI	K	Gear	Finishes
TC1	10 100mm	H Horizontal	01 150lm	65 65	SY Symmetric	8 80	30 3000 K	N ON/OFF	B Black 07
TC1	10	H	01	65	SY	8	30	N	B

TRACE IP65 200 AS

Family	Dimension	Format	Lm LED	IP	Optic	CRI	K	Gear	Finishes
TC1	20 200mm	H Horizontal V Vertical	02 150lm	65 65	AS Asymmetric	8 80	30 3000 K	N ON/OFF	B Black 07
TC1	20	H	02	65	AS	8	30	N	B

TRACE IP65 200 SY

Family	Dimension	Format	Lm LED	IP	Optic	CRI	K	Gear	Finishes
TC1	20 200mm	V Vertical	02 300lm	65 65	SY Symmetric	8 80	30 3000 K	N ON/OFF	B Black 07
TC1	20	V	02	65	SY	8	30	N	B

Mandatory accessory



TECHNICAL CHARACTERISTICS

Optics

100 SY

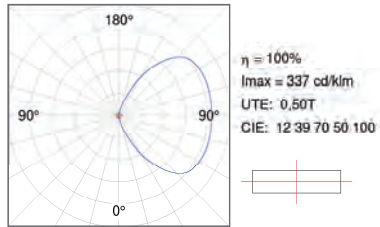

200 AS H

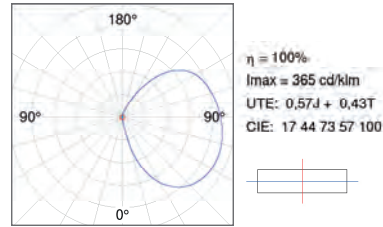

200 AS V

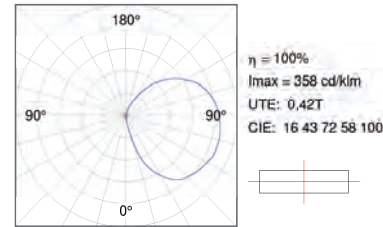

200 SY

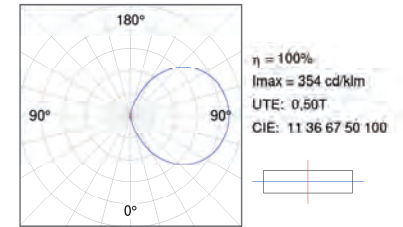

Light output and power

100 SY

	150lm			
	K	CRI	W	lm Output
SY	3000	80	2,7	68

200 AS H/V

	150lm			
	K	CRI	W	lm Output
AS H	3000	80	2,7	92
AS V	3000	80	2,7	94

200 SY

	300lm			
	K	CRI	W	lm Output
SY	3000	80	4,1	156

ACCESSORIES

TRACE 65 100 recessed box



Ref.
TCREB065100

Color
●

TRACE 65 200 recessed box



Ref.
TCREB065200

Color
●



Urban 100

Urban 100

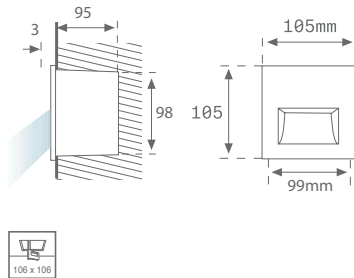

URBAN 100

Family	Formats	Lm LED	Optic	Óptica	CRI	K	Gear	Finishes
UR1	SQ Square	04 400lm	AS Asymmetric	65 65	9 90	27 2700 K 40 4000 K	N ON/OFF	G Grey 03
UR1	SQ	04	AS	65	9	27	N	G

TECHNICAL CHARACTERISTICS

Optics

URBAN 100

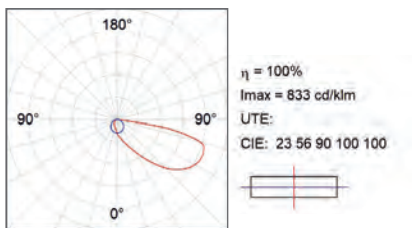

Light output and power

URBAN 100

		400lm	
K	CRI	W	lm Output
2700	90	1,7	113
4000	90	1,7	113





Xtrema

Xtrema
40

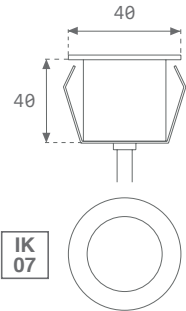

Xtrema
60

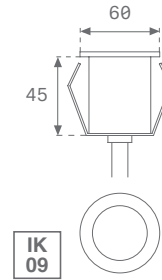

XTREMA

Family	Format	Lm LED	IP	Optic	CRI	K	Gear CV 24V	Finishes
XT2	40 40mm	01 100lm	67 IP67	WF WFL	8 80	30 3000 K 40 4000 K	0 ● Not Included	I Inox
	60 60mm	03 300lm						
XT2	40	01	67	WF	8	30	0	I

● Driver 24V

TECHNICAL CHARACTERISTICS

Optics

XTREMA 40

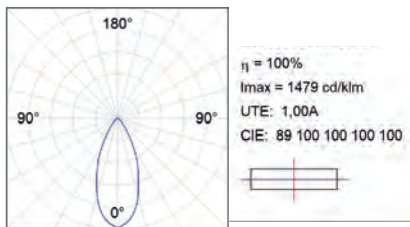

XTREMA 60

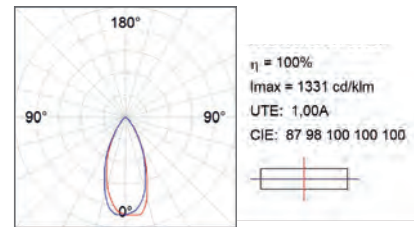

Light output and power

XTREMA

K	CRI	100lm		300lm	
		W	lm Output	W	lm Output
3000	80	1	85	3	174
4000	80	1	85	3	174



ACCESSORIES

Xtrema 40 recessing box

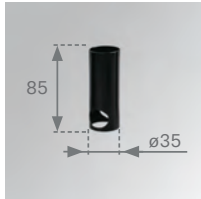

Ref.
X4B036B

Xtrema 60 recessing box

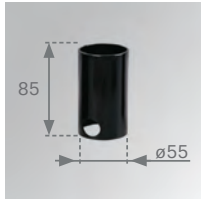

Ref.
X6B056B

IP67 4 poles connector



Ref.
CT4P67N

IP67 Driver



Ref.
DRV6710024N
DRV6710024D



General Acc. Outdoor

URBAN SYSTEM

Shot/Flut short individual final a m



Ref.	Color	ømm	fi .
COARSHIN60G	●	60	1
COARSHIN60A	●	60	1
COARSHIN76G	●	76	1
COARSHIN76A	●	76	1

Shot/Flut long individual final a m



Ref.	Color	ømm	fi .
COARLOIN60G	●	60	3
COARLOIN60A	●	60	3
COARLOIN76G	●	76	3
COARLOIN76A	●	76	3

Shot/Flut short double final a m



Ref.	Color	ømm	fi .
COARSHDB60G	●	60	2
COARSHDB60A	●	60	2
COARSHDB76G	●	76	2
COARSHDB76A	●	76	2

Shot/Flut long double final a m



Ref.	Color	ømm	fi .
COARLODB60G	●	60	4
COARLODB60A	●	60	4
COARLODB76G	●	76	4
COARLODB76A	●	76	4

Shot/Flut short individual intermediate arm



Ref.	Color	ømm	fi .
COARSHINT080G	●	min. 80	5
COARSHINT080A	●	max. 120	5

Shot/Flut long individual intermediate arm

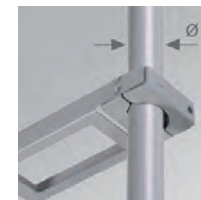

Ref.	Color	ømm	fi .
COARLOINT080G	●	min. 80	6
COARLOINT080A	●	max. 120	6

Shot/Flut long wall arm



Ref.	Color	ømm	fi .
FXARWAG	●	0,8	8
FXARWAA	●	0,8	8

● Scheme P 405

URBAN SYSTEM

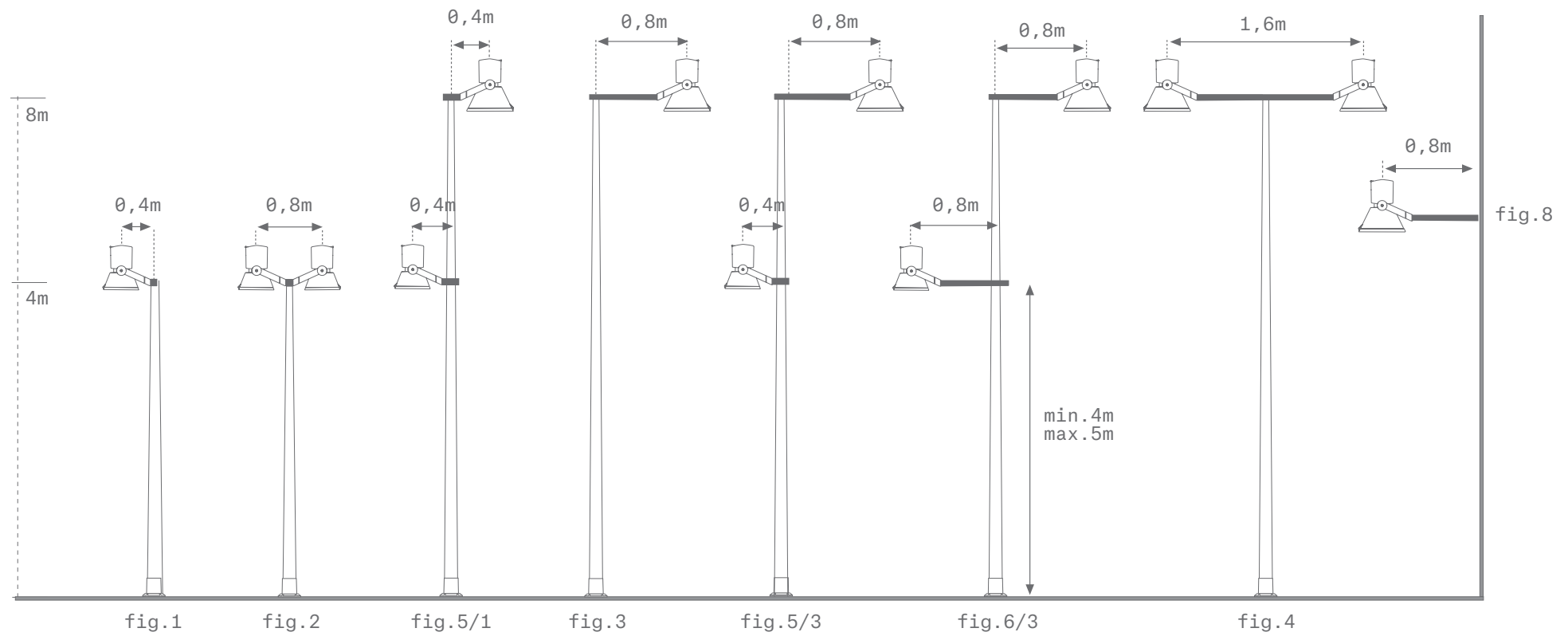

Technical General Information



LIGHTING AT WORKPLACES IN ACCORDANCE WITH THE STANDARD UNE - EN 12464-1

ACTIVITY TYPE	LUX	UGR _L	R _a
OFFICES			
Filing, copies	300	19	80
Writing, typewriter, reading, data processing	500	19	80
Technical drawing	750	19	80
CAD work stations	500	19	80
Conference and meeting rooms	500	19	80
Reception desk	300	22	80
RETAIL ESTABLISHMENTS			
Sales' area	300	22	80
Boxes area	500	19	80
Wrapping table	500	19	80
PUBLIC PLACES			
Common Areas			
Lobbies	100	22	80
Wardrobes	200	25	80
Lounges	200	22	80
Ticket offices	300	22	80
Restaurants and hotels			
Reception, cash desk and porter's office	300	22	80
Kitchens	500	25	80
Restaurant, dining room and meeting rooms	-	-	80
Conference rooms	500	19	80
Corridors	100	25	80

Fairs, trade show pavilions, theatres, cinema and concert theatres			
General lighting	300	22	80
Museums			
Works on display which are insensitive to light	Lighting determined by presentation requirements		
Works on display which are sensitive to light			
Libraries			
Shelving	200	19	80
Reading area	500	19	80
Public service positions	500	19	80
Public vehicle car parks (interior)			
Access or exit ramps (daytime)	300	25	80
Access or exit ramps (night-time)	75	25	80
Walkways	75	25	80
Parking area	75	-	80
Cash desk	300	19	80
INDUSTRIAL AND CRAFT ACTIVITIES			
Agriculture			
Loading and operations with items and machinery	200	25	80
Livestock building	50	-	40
Veterinary room, birthing barns	200	25	80
Cement, cement items, concrete, bricks			
Drying	50	28	20
Preparation of materials, work in kilns and mixers	200	28	40
Machine work in general, formworking	300	25	80



LIGHTING AT WORKPLACES IN ACCORDANCE WITH THE STANDARD UNE - EN 12464-1

ACTIVITY TYPE	LUX	UGR _L	R _a
Ceramics, tiles, glass			
Drying	50	28	20
Preparation, general machine work	300	25	80
Glazing, Laminating, baking	300	22	80
Grinding, engraving, polishing	750	19	80
Grinding of optical glass	750	19	80
Precision work	1000	16	90
Manufacture of gemstones	1500	16	90
Plastics and Rubber Chemical Industry			
Treatment facilities with remote control	50	-	20
Treatment facilities with manual control	150	28	40
Protected Work stations in installations	300	25	80
Precision measuring rooms, laboratories	500	19	80
Pharmaceutical and tyre production	500	22	80
Inspection of colours	1000	16	90
Cutting, finishing, inspection	750	19	80
Electrical industry			
Manufacture of cable and wire, big coils	300	25	80
Small coils	750	19	80
Impregnation and galvanized coils	300	25	80
Coarse assembly work (transformers)	300	25	80
Assembly work environment (meter box)	500	22	80
Assembly work fine (phones)	750	19	80

Precision assembly work (meas. eq.)	1000	16	80
Electronic Workshops	1500	16	80
Foodstuffs and luxury foods industry			
Work stations, brewery	200	25	80
Work stations for washing, cleaning	200	25	80
Work stations in cooking zones	200	25	80
Work stations in sugar plants	200	25	80
Work stations, tobacco drying and fermenting	200	25	80
Classification and washing products	300	25	80
Work stations in slaughterhouse critical areas	500	25	80
Cutting and classification of fruit and vegetables	300	25	80
Manufacture of delicatessen products	500	22	80
Inspection of glasses and bottles	500	22	80
Laboratories	500	19	80
Inspection of colours	1000	16	80
Foundries and metal casting			
Pits, caves	50	-	20
Platforms	100	25	40
Sand preparation	200	25	80
Changing rooms	200	25	80
Work stations in mixer	200	25	80
Casting nave, molding machine	200	25	80
Hand molding and in cores and injection molding	300	25	80
Construction of models	500	22	80



LIGHTING AT WORKPLACES IN ACCORDANCE WITH THE STANDARD UNE - EN 12464-1

ACTIVITY TYPE	LUX	UGR _L	R _a
Bakeries			
Preparation and baking ovens	300	22	80
Finishing, baking, decoration	500	22	80
Hairdressers'			
Hairdressing work	500	19	90
Jewel manufacture			
Work with precious stones	1500	16	90
Jewel manufacture	1000	16	90
Manual watchmaking	1500	16	80
Automatic watchmaking	500	19	80
Laundries and dry cleaner's			
Marking, classification of items and washing	300	25	80
Dry cleaning, ironing and steam ironing	300	25	80
Inspection and repairs	750	19	80
Leather and leather items			
Working with paints, barrels and pits	200	25	40
Cleaning and rubbed skins	300	25	80
Tanning, shoemaking	500	22	80
Quality control	1000	19	80
Inspection of colours	1000	16	90
Metal work and treatment			
Open die forging	200	25	60
Hot stamping, welding	300	25	60

Tool making	750	19	60
Rough assembly	200	25	80
Mean assembly	300	25	80
Fine assembly	500	22	80
Precision assembly	750	19	80
Galvanization	300	25	80
Preparation of surfaces and painting	750	25	80
Tool making, micromechanics	1000	19	80
Paper and paper items			
Vertical mill and pulp	200	25	80
Paper processing and manufacturing	300	25	80
Standard binding, folding, gluing	500	22	80
Electrical energy plants			
Boiler casing	100	28	40
Machine rooms	200	25	80
Presses			
Cutting, engraving, typography, printing blocks, printing	500	19	80
Classification of paper and hand printing	500	19	80
Rate adjustments, retouches, lithography	1000	19	80
Inspection of colour printing, multicolour	1500	16	90
Recorded in steel and copper	2000	16	80
Rolling, steel plants			
Product installation without manual intervention	50	-	20
Product installation with continuous manual intervention	200	25	80



LIGHTING AT WORKPLACES IN ACCORDANCE WITH THE STANDARD UNE - EN 12464-1

ACTIVITY TYPE	LUX	UGR _L	R _a
Ovens	200	25	20
Mill, coiler	300	25	40
Control platforms	300	22	80
Tests, measurement and inspection	500	22	80
Textile industry			
Working posts and services	200	25	60
Carding, ironing, washing, combing	300	22	80
Yarn, folding, rolling, winding, weaving	500	22	80
Sewing, knitting, seams, patterns	750	22	80
Finishing, dyeing	500	22	80
Drying room	100	28	60
Automatic printing of fabrics	500	25	80
Inspection of colours, fabric control	1000	16	90
Invisible Darning	1500	19	90
Vehicle Manufacturing			
Body and Assembly	500	22	80
Painting, spraying, polishing	750	22	80
Painting, retouching, inspection	1000	19	80
Upholstery Fabric	1000	19	80
Timber industry and its treatment			
Automatic processing, drying, board manufacture	50	28	40
Treatment with steam	150	28	40
Work on joints, gluing, assembly	300	25	80

Finishing, painting, fine assembly	750	22	80
Shaped, striatum, straightening, slotted	500	19	80
Wood selection of plates	750	22	90
Marquetry, wood inlay	750	22	90
Quality control, inspection	1000	19	90

EDUCATIONAL ESTABLISHMENT

Kindergartens, nurseries, educational buildings

Classes, tutoring classes	300	19	80
Classes for adult evening classes	500	19	80
Technical drawing classes	750	16	80
Practical classes, laboratories, workshops	500	19	80
Music rooms, computer and language	300	19	80
Classroom preparation and workshops	500	22	80
Lobbies, study classes	200	22	80

HOSPITALS, DOCTORS' SURGERIES, CLINICS

Common classes	200	22	80
Corridors (Daytime)	200	22	80
Corridors (night time)	50	22	80
Diagnostic rooms, general lighting	500	19	90
Diagnostic rooms, lighting visit or treatment	1000	19	90
Operating room	1000	19	90
Pharmacy, laboratory, dental doctor	500	19	90
Intensive Care	1000	19	90
Disinfection and sterilisation rooms	300	22	80

LUX: Mean horizontal lighting level. Generally calculated at a height of around 85 cm from the ground, always in working areas and level with its circulation or thoroughfare areas.

UGR: Internal Unified Glare Index Limit of the area. This establishes the direct glare onto each application depending on the distribution of the luminaires vis-à-vis the features of the area to be lit up and the observation point of the operators.

R_a: General colour rendering index of light sources.



PICTOGRAPH

CLASE I	Luminaire in which protection against electric shocks is based, in addition to the main insulation, upon the earthing of accessible conductive parts.	CE	CE self-certification.
	Luminaire in which protection against electric shocks is not based upon the main insulation, but rather upon complementary safety measures such as double insulation.		Luminaire without required control gear built-in.
	Luminaire in which protection against electric shocks is based on a very low safety voltage.		TRIAC Trailing edge
	Luminaires should never be covered with any heat insulating material.		Outdoor luminaire for under canopy installation.
XX°	Maximum adjustment angle of the luminaire.		Luminaire not including end covers.
XXX°	Maximum adjustment angle of the luminaire.		1m HO7RN-F (3x1,5) hose included.
	Maximum adjustment angle of the two axes of a gimbal luminaire.		Luminaire designed for double switching.
	Luminaire with built-in glass.		Anodized: Electrolytic passivation process which objective is to protect against corrosion.
AISI XXX	Stainless Steel.		Classification Risk 0 (Exempt group) according to EN62471
	Polycarbonate body.		Recycled polycarbonate body.
	Aluminium body.		Recycled aluminium body.
	Electro coating. Painting process which objective is to protect against corrosion.		Luminaire with dynamic white light source (2700-6500 K)
	Material which has successfully passed the incandescent filament test at the indicated temperature.		Suitable for saline environments.
	Floor aperture diameter.		Unified Glare Rating <19 (Dimensions 4H8H Refl ctances: 70/50/20)
	Ceiling aperture diameter.		Wellbeing Technology
	Rectangular ceiling aperture dimensions.		Methacrylate Diffuser
	Maximum panel thickness for luminaire anchoring point.		Active Cooling. Model which incorporates active dissipation.
			DALI control gear.



CO-CREATION PICTOGRAPH

Dimmable 1-10V	Lengths
Dimmable PUSH	Formats
Dimmable TRIAC	Finishes
Dimmable DALI	Finished in serigraphy
Emergency battery	Sensor Integration
Bluetooth control	Trimless installation
LED for RETAIL (VW, meat, fish, bread, fruit)	IP65
Other distributions	Adaptation for Marine Environments
Light Output	Opal diffuser
Colour Temperature	IK 10 with PC Diffuser
Amber LED	Outdoor installation
Colour rendering index	Wellbeing Technology
Tunable white	

Technical General Information



IP CODE

In agreement with the norm EN 60598-1, the luminaires are classified according to the derived protection of its constructive elements. The nomenclature comes symbolised by the letters IP followed of three figures, although the two first ones are indicated.



● 1st figure

Protection of the material against the filtration of solid elements and dust, as well as to the people in respect to the tension of the components of the luminaire.

- 0 - Not protected.
- 1 - Protection against solid bodies bigger than 50 mm.
- 2 - Protection against solid bodies bigger than 12 mm.
- 3 - Protection against solid bodies bigger than 2,50 mm.
- 4 - Protection against solid bodies bigger than 1 mm.
- 5 - Protection against the dust.
- 6 - Complete protection against the dust.

● 2nd figure

Protection of the material to the penetration of liquid.

- 0 - Not protected.
- 1 - Protected against steady dripping.
- 2 - Protected against falling water to a maximum 15°.
- 3 - Protected against rain.
- 4 - Protected against sprays.
- 5 - Protected against water jets.
- 6 - Protected against waves.
- 7 - Water-tight immersion.
- 8 - Water-tight against immersion.

IK CODE

Code system which indicates the degree of protection given by a body and the protector against harmful mechanic impacts.















IK	Impact energy (J)
IK00	0
IK01	0,15
IK02	0,2
IK03	0,35
IK04	0,5
IK05	0,7
IK06	1
IK07	2
IK08	5
IK09	10
IK10	20





Technical General Information



OPTICS









































Optics	△
 Superspot (SSP)	0° - 9°
 Spot (SP)	10° - 19°
 Medium Flood (MFL)	20° - 29°
 Flood (FL)	30° - 39°
 Wide Flood (WFL)	40° - 69°
 Very Wide Flood (VWFL)	>70°
 Elliptical	12° x 30°
 Street	-
 Direct / Indirect	-
 Opal	-
 Prismatic	-
 360°	-

COLOR TEMPERATURE

K	Color	
5000 K	Cool White	
4000 K	Neutral White	
3000 K	Warm White	
2700 K	Very Warm White	
2700-6500 K	Tunable White	



FINISHES

 BLACK: B	
 Black 01	RAL 9005 BLACK
 Black 02	RAL 9011 BLACK MATT
 Black 03	RAL 9011 BLACK TEXTURIZED
 Black 04	RAL 9011 BLACK BRIGHT
 Black 05	RAL 7021 TEXT. MATT
 Black 06	CATAPHORESIS
 ANTHRACITE: A	
 Anthracite	ANTHRACITE
 GREY: G	
 Grey 01	RAL 9006
 Grey 02	ANODIZED SILVER MATT
 Grey 03	SW GREY TEXTURIZED
 INOX: I	
 Inox 01	STAINLESS STEEL AISI 303
 Inox 02	STAINLESS STEEL AISI 304
 CHROME: R	
 Chrome 01	CHROME 1
 WHITE: W	
 White 01	RAL 9104 WHITE TEXTURIZED
 White 02	RAL 9010 WHITE MATT
 White 03	RAL 9010 WHITE TEXTURIZED
 White 04	RAL 9010 WHITE BRIGHT
 White 05	RAL 9016 WHITE TEXTURIZED
 White 06	RAL 9016 WHITE MATT
 YELLOW: Y	
 Yellow 01	RAL 1021 TEXTURIZED
 CUPPER: C	
 Cupper 01	CUPPER MATT
 WELLBEING: 3	
 4050-R90B	
 1505-Y10R	
 7024	
 4030-B50G	
 7001	
 BE SOCIAL: 4	
 4050-R90B	
 1050-B10G	
 7502-R	
 2070-Y80R	
 2011	
 MATERIALITY: 1	
 1505-Y10R	
 7024	
 3010-G	
 2010-Y20R	
 3013	
SPECIAL COLORS	
Different colors from the ones settled on the price list are considered as special executions . Enquire for price and delivery time.	
When applied, there may be small differences between the original colors and those obtained on certain final products.	

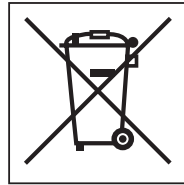

Attached to ECOTIC Foundation for the Environment, applying the Community Directive 2002/96/CE RAEE'S, for recycling waste from electrical and electronic lighting devices. The ECORAEE economic management cost of luminaires is borne by Lamp. As regards the Lamps included in some of our luminaires, they shall be subject to the ECORAEE rate charged to us by the manufacturer.

The following conditions for the return of lighting materials shall be applicable to Lamp S.A.U.'s supplies:

- 1º All returns not due to manufacturer's error must be previously authorised by the company.
- 2º Returns of special material, that is to say, outside the current price list shall not be accepted.
- 3º All returns shall always make reference to the invoice and/or delivery note, with which they were supplied.
- 4º Under no circumstances shall any material that is more than 90 days old, according to the supply invoice date, be admitted for return.
- 5º In the event that the return of a material is expressly accepted, this shall be in its original packaging, in complete boxes, unopened and in good condition, as if it were a new product.
- 6º The return of the material shall be made carriage paid and at the client's expense and risk.
- 7º Payment regarding any authorised return shall entail a minimum depreciation of 15% of the net amount of the invoice.

General Terms and Conditions of Sale



The acceptance by **LAMP S.A.** of any order implies complete acceptance by the purchaser of these General Terms and Conditions of Sale.

1. Prices

Prices shall be those applicable at the date of receipt of the order, applying agreed discounts. A specific quotation must be sought for out-of-catalogue and specially-executed articles.

2. Order confirmation

The client must check the confirmation for the order submitted within 72 hours. The Client shall be solely responsible for the accuracy of the order, including specifications, configuration or other requirements of the Products and Services. They shall also be responsible for checking the functionality, compatibility with control systems and interoperability with other products not supplied by LAMP, as well as the suitability for a particular use. The Client guarantees that the information provided to LAMP is complete, accurate and true, and the Client further acknowledges that failure to provide complete, accurate and true information or instructions to LAMP may impair LAMP's ability to perform its obligations or exercise its rights under an Agreement.

3. Deliveries

The place of delivery of the material ordered and thus that of the associated sale, is always deemed to be our factory or storage facility (ex-works). Goods thereafter travel at the purchaser's own risk and expense unless the order is accepted on a carriage paid basis. The risks relating to product return will always be assumed by the purchaser. In the event of serious difficulties, **LAMP** will cover the orders depending on their possibilities.

4. Delivery period

To provide our customers with guidance on likely availability of product in our warehouse, we have classified our products as follows:

- Guiding availability term: **1 week** (from the date of the formalization of the order)
- Guiding availability term: **2 weeks** (from the date of the formalization of the order)
- Guiding availability term: **to be determined by LAMP** (from the date of the formalization of the order)

The blue dots ● are indicated before each product code.

Confirmation of delivery periods must be sought for each order. All these terms can be increased in one day due to the expedition process. **LAMP S.A. shall not be answerable nor liable for any penalty in the case of failure to meet such delivery periods.**

5. Transport

Unless agreement is reached to the contrary, carriage shall always be borne by the purchaser.

The recipient shall have a duty to examine goods upon receipt and place on record any problems on the goods delivery note or make a claim with 48 hours to their transport agency if sent on a carriage forward basis, or to Lamp, if made on a freight paid basis.

6. Cancellation of orders

All cancellations of orders must be made in writing. Should cancellation occur after delivery of an order, it will be treated as a return, the procedure for which is governed by Clause 9. Specially-executed orders cannot be cancelled when production thereof has already commenced.

7. Samples

All samples of materials must be requested by means of an order and shall be invoiced. When returned, they shall be credited in full unless damaged or modified.

8. Specially-executed orders

Specific inquiries of any out-of-catalogue must be made prior to an order being placed to ascertain its viability, price and delivery period.

9. Lighting projects

We are happy to offer all our customers the free service provided by our **Technical Projects Department**, which can carry out a lighting calculation study.

Together with the technical report, you will receive a lighting quotation and plan to assist with the implementation of the works. You can also request, free of charge, our lighting calculation program on CD.

10. Returns

LAMP S.A. will accept returns of all those goods marked in the price list with a symbol ● (a single blue dot).

- Required procedures:

- Customers must have made the original order in writing (fax, e-mail, letter, etc.)
- They must request a return merchandise authorisation (RMA) number from **LAMP S.A.**
- The relevant goods must not be damaged in any way.

- Return deadline:

- RMA numbers must be requested within 90 calendar days of the date of shipment of the relevant goods.
- Returns must be made within 30 calendar days of the date of receipt of the RMA number (which **LAMP S.A.** shall notify in writing).

- Conditions:

- **LAMP S.A.** shall be entitled not to accept any return, whatever the reason therefor, in any of the following cases:

- Breach of required procedures and/or deadlines.
- Out-of-catalogue items.
- Specially-executed orders (non-standard electrics, measurements, etc.)
- Goods painted in non-standard colours.
- Goods marked in the prices list with the following symbols: ●● (two blue dots) and/or ●●● (three blue dots).

- All duly-authorised returns shall be sent to **LAMP S.A.** carriage paid.

- Credit notes:

LAMP S.A. shall issue credit notes for all returns which meet each and every one of the above requirements in respect of procedures, deadlines and conditions for 85% of the originally-invoiced sum. The remaining 15% shall be set aside to cover the costs in respect of the return (handling, packaging, quality control...)

Credit notes arising due to causes other than returns (differences in prices, carriage, errors, etc.) shall also be subject to the above procedural and deadline requirements, that is, the original order must be made in writing and the related claim must be made within 90 calendar days of the date of issuing of the invoice.

A further prerequisite is that customer is fully up to date with all its payment duties.

11. Quality

All products supplied by **LAMP S.A.** have received CE certification, meet other standards and regulations and have been subject to strict quality controls which guarantee their proper working.

LAMP S.A. is continually working to improve and update its products. It therefore reserves the right to change, withdraw or expand its products without prior notice and without this giving rise to the right to make any form of claim or complaint.

12. Warranty

LAMP S.A.U. guarantees the perfect working order of each and every one of its products against any defect in relation to materials or labour involved in the manufacture of the same. The commercial warranty provided by **LAMP S.A.U.** is an extension of the mandatory six-month legal warranty (Law 23/2003) and is specified as follows: The warranty for LED products featuring the "5-year warranty" tag on the technical data sheet is extended to 5 (FIVE) years, and to 2 (TWO) years for all other standard products, valid as of the date of delivery. Furthermore, the warranty period for the repair or replacement of lamp products is extended to the 2 or 5 years specified in this legal warranty extension. The scope of the Lamp warranty covers all Spanish and international territory. The corresponding claim should be delivered to our commercial department in writing in order to render the warranty valid. Our warranty includes the repair, replacement or exchange of the product and/or components at no cost to the customer, excluding labour, in addition to transportation costs arising from compliance with the warranty. All the technical specifications of the Lamp warranty, in addition to the rights of the consumer, are set forth in the General Warranty Conditions document: <http://www.lamp.es/files/64880>.

13. Reservation of title

LAMP S.A. reserves title over all the goods it supplies until the purchaser has paid for them in full.

14. Jurisdiction

In the case of any disagreement or dispute over these General Terms and Conditions of sale, both parties, expressly waiving any other jurisdiction, submit themselves to the authority of the Courts and Tribunals of the city of Terrassa (Barcelona).

NB: This document replaces all previous versions. Data valid for orders received from February 1st 2021.



Worktitude for light

Lamp (11/2024)

Published by:

Lamp S.A.U

Co-ordination, Graphic Desing, Layout and Editorial:
Dept. Marketing Lamp



Lamp EUROPE

Lamp HEADQUARTERS

Córdoba, 16
08226 Terrassa (Spain)
T. +34 93 736 68 00
lamp@lamp.es

Lamp FRANCE

124 rue Réaumur
75002 Paris (France)
T. +33 (0) 5 62 13 91 14
france@lamp.es

Lamp AMERICA

Lamp CHILE

Exequiel Fernández,
2251 Macul, Santiago (Chile)
T. +56 2 2237 17 70
F. +56 2 2375 52 73
chile@lamp.cl

Lamp COLOMBIA

Calle 74B N° 69-15
Bogotá (Colombia)
T. +57 (1) 7430092
colombia@lamp.com.co

Lamp MEXICO

Granjas México
08400 México DF (México)
T. +52 55 5648 5350
mexico@lamp.es

Lamp MIDDLE EAST

Lamp MIDDLE EAST

Jumeirah Bay X2 - 3rd Floor
Cluster X - Jumeirah Lake Towers
P.O. BOX 126732
Dubai (UAE)
T. +971 4 437 5716
uae@lamp.es